

Heirloom Wearables: A Hybrid Approach to the Design of Embodied Wearable Technologies

Christine Dierk



Electrical Engineering and Computer Sciences
University of California at Berkeley

Technical Report No. UCB/EECS-2020-138

<http://www2.eecs.berkeley.edu/Pubs/TechRpts/2020/EECS-2020-138.html>

July 31, 2020

Copyright © 2020, by the author(s).
All rights reserved.

Permission to make digital or hard copies of all or part of this work for personal or classroom use is granted without fee provided that copies are not made or distributed for profit or commercial advantage and that copies bear this notice and the full citation on the first page. To copy otherwise, to republish, to post on servers or to redistribute to lists, requires prior specific permission.

Heirloom Wearables:
A Hybrid Approach to the Design of Embodied Wearable Technologies

by

Christine Dierk

A dissertation submitted in partial satisfaction of the

requirements for the degree of

Doctor of Philosophy

in

Computer Science

and the Designated Emphasis

in

New Media

in the

Graduate Division

of the

University of California, Berkeley

Committee in charge:

Professor Eric Paulos, Chair

Professor Björn Hartmann

Professor Kimiko Ryokai

Summer 2020

Heirloom Wearables:
A Hybrid Approach to the Design of Embodied Wearable Technologies

Copyright 2020
by
Christine Dierk

Abstract

Heirloom Wearables:
A Hybrid Approach to the Design of Embodied Wearable Technologies

by

Christine Dierk

Doctor of Philosophy in Computer Science

and the Designated Emphasis in

New Media

University of California, Berkeley

Professor Eric Paulos, Chair

Device miniaturization and new materials have enabled wearable technology to be integrated more seamlessly with the body, leveraging form factors such as clothing, jewelry, temporary tattoos, and beyond. While adopting familiar forms, many of these new technologies inherit interaction modalities and usage patterns from existing technologies (e.g. Smartphones), rather than being inspired by the rich cultural history and connotations of the form factor itself. In this thesis, I motivate the unique opportunities that arise when incorporating existing practices and cultural meaning into the design of wearable technologies.

I define a new class of wearable technologies that adopt existing form factors, leveraging well-established body practices and traditions — *Heirloom Wearables*. I argue that this class of wearable technologies can foster meaningful relationships with technology on the body that more closely resemble experiences with traditional body-worn artifacts than modern wearable technologies. I present a lightweight framework to facilitate the design of *Heirloom Wearable* technologies, and detail five exemplar prototypes designed to operationalize the framework: fingernail-worn devices, interactive hair, dynamic clothing & accessories, interactive hats, and lotion interfaces. The concept of *Heirloom Wearables*, the framework, and the exemplar prototypes demonstrate how the limitations and constraints of body-based technologies can be transformed into opportunities for design, and highlight how body-centric practices can inform new and embodied wearable technologies.

As a result, this work contributes a design methodology towards a more diverse range of inclusive wearable technologies. This new landscape of devices blurs the distinction between

modern wearable technologies and traditional body-worn artifacts, fostering meaningful and intimate relationships with technology on the body.

For my family:

my grandmothers —the seamstress and the entrepreneur,

my father and his father —the engineers,

my sister, mother, and grandfather —the educators,

my brother —the most creative person I know,

and Austen Marie.

Contents

Contents	ii
List of Figures	v
List of Tables	xv
1 Introduction	1
1.1 Heirloom Wearables	3
1.2 Contribution	6
1.3 Outline	7
1.4 Statement of Multiple Authorship and Prior Publication	8
2 Design Framework for Heirloom Wearables	10
2.1 Motivation	10
2.2 Existing Approaches	10
2.3 Design Framework for Heirloom Wearables	17
2.4 Summary	23
3 Related Work	25
3.1 Ubiquitous, Wearable, & Slow Computing	25
3.2 Expanding Landscape of Wearable Technologies	26
3.3 Summary	33
4 Fingernail Devices	34
4.1 Introduction	34
4.2 Related Work	36
4.3 Constraint Driven Design	37
4.4 AlterNail	38
4.5 AlterWear Fingernail Form Factor	42
4.6 TransformatioNail	43
4.7 Design Space Exploration	51
4.8 Discussion	59
4.9 Summary	62

5	Interactive Hair	63
5.1	Introduction	63
5.2	Related Work	65
5.3	Design Considerations	67
5.4	HäirIÖ	69
5.5	User Study	78
5.6	Discussion	82
5.7	Summary	84
6	Dynamic Clothing and Accessories	85
6.1	Introduction	86
6.2	Related Work	87
6.3	AlterWear	87
6.4	User Study	101
6.5	Discussion	107
6.6	Summary	108
7	Interactive Hats	111
7.1	Introduction	112
7.2	Related Work	113
7.3	Design Considerations	114
7.4	User-Defined Gestures for Hat Technology	117
7.5	Design and Fabrication of Interactive Hats	126
7.6	Evaluation	130
7.7	Discussion	133
7.8	Summary	134
8	Lotion Interfaces	136
8.1	Introduction	137
8.2	Related Work	140
8.3	Design Considerations	141
8.4	Lotio	144
8.5	Preliminary User Study	149
8.6	Envisioned Applications	152
8.7	Discussion	155
8.8	Summary	159
9	Discussion	161
9.1	Illustrative Designs	162
9.2	Extensions of the Framework	171
9.3	Synthesis	172

10 Conclusion	174
10.1 Restatement of Contributions	174
10.2 Future Research Directions	176
10.3 Summary	177
Bibliography	179

List of Figures

1.1	Left: head-worn camera envisioned by Vannevar Bush in 1945; Right: shoe-worn device implemented by the Eudaemons in the late 1970s.	1
1.2	Left: Steve Mann pictured with Wearable Computing prototypes from the 1980s to the 1990s; Right: Wearable Computing from the Media Lab at MIT [171] . .	2
1.3	This dissertation discusses the design and implementation of five exemplar <i>Heirloom Wearable</i> technologies: fingernail devices, interactive hair, dynamic clothing & accessories, interactive hats, and lotion interfaces. These <i>Heirloom Wearables</i> expand the landscape of body-worn technologies.	5
2.1	Body surface map of the distribution of wearable technologies released or prototyped between February 2014 and April 2015 [11]. A more recent survey of commercially available wearable devices published in 2019 confirms this distribution, with 46% of surveyed devices worn on the wrist [78].	11
2.2	Movement Sensor Placement Body Map [225].	12
2.3	Body surface map of garment edges, features, and zones of accessibility and social weight for (a) women and (b) men [45].	14
2.4	WEAR scale for predicting social acceptability of wearable technologies [92]. . .	15
2.5	Crowdsourced heatmaps conveying comfort (both physical and social) of projected displays at various body locations [62]. Green represents high levels of comfort; red represents low levels of comfort.	16
2.6	Aestheticism and Mutability of various body-worn artifacts. Commercially prevalent wearable technologies are highlighted in dark blue.	21
2.7	Removability and Mutability of various body-worn artifacts. Commercially prevalent wearable technologies are highlighted in dark blue.	22
2.8	Aestheticism and Visibility of various body-worn artifacts. Commercially prevalent wearable technologies are highlighted in dark blue.	23
3.1	E-textiles: (a) Vilkas dress with kinetic nitinol hemline; (b) embroidered fabric keypad with composite image of attached circuit board; (c) Ebb thermochromic textile display; (d) Levi's Commuter X Jacquard By Google trucker jacket. . . .	27

3.2	High Fashion expressive accessories. Left: fiber optic Louis Vuitton Keepall; Middle: Cute Circuit Mirror Handbag; Right: Lumen Couture LED Matrix Face Mask.	29
3.3	Commercially prevalent wearable technologies in the form of accessories. Left: Ringly notification ring; Middle: Apple Watch smartwatch; Right: Google Glass data glasses.	30
3.4	Skin-worn interfaces leveraging temporary tattoo form factors and skin-worn silicone overlays. (a) touch input enabled through Skintillates; (b) color-changing DuoSkin interface; (c) electroluminescent SkinMarks display; and (d) touch input enabled through AnimSkin.	31
3.5	Wearable technologies leveraging cosmetic form factors. From left to right: Beauty Technologies in the form of (a) hair extensions and (b) conductive makeups; Hybrid Body Crafts in the form of (c) nail-mounted electronics and (d) cosmetic chemical sensing powders.	32
4.1	Rigidity and Removability of various body-worn artifacts. Artificial Fingernails (shown in pink) occupy a unique location in the design space as a rigid artifact that is infrequently removed. Most prevalent wearable form factors are shown in dark blue. Although, lotion and makeup alone are very deformable, we are specifically considering the properties of the form factors once applied to the body. Thus, lotion, makeup, and tattoos all assume the rigidity of skin: flexible but not deformable.	35
4.2	Three generations of fingernail devices. All devices are powered wirelessly and feature an e-ink display. From Left to Right: AlterNail, AlterWear, TransformationNail.	36
4.3	AlterNail being worn and closeup of an AlterNail design.	39
4.4	Custom designed AlterNail with accelerometer, ATTiny85, a wireless power receiver, inductive coil, and e-ink display.	40
4.5	Left: Credits and Usage scenario demonstrated with an AlterNail enabled cookie jar. When the user opens the cookie jar, a new dot is added to their AlterNail display. Middle: Object Status scenario demonstrated with an AlterNail enabled chisel. As displayed by the AlterNail, this tool has been used three times today. Right: AlterNail updated through NFC from a smartphone. The user can discreetly check that they have one new email without unlocking and looking at their phone.	41
4.6	The fingernail AlterWear design with custom circuitry and e-ink (Left) and folded over into a more compact fingernail form factor exposing the dynamically programmable e-ink dot pattern (Middle) next to an actual fingernail (Right).	43

4.7	TransformatioNail is a small fingernail worn device that attaches to the nail with acrylic nail glue. The core component is a custom designed PCB (right) that includes an e-ink display, among other components. The e-ink display folds over to make the nail more compact (middle). The size of the nail is comparable to a generic acrylic nail (left).	44
4.8	Custom designed PCB containing an e-ink display, ATTiny85 microcontroller, NT3H1101 NFC tag, and an ADXL345 accelerometer. A coil is etched into the backside of the board for both data and power transfer. The size of the PCB is 13.45mm x 19.85mm and 3.55mm thick.	45
4.9	TransformatioNails can augment interactions with existing technology.	49
4.10	Bookmarks. Lina can't decide whether or not to purchase the beautiful yellow scarf she finds in an airport boutique while awaiting her departure. Feeling under pressure, she double taps the NFC-enabled price tag to "bookmark" the scarf and heads to her gate empty handed. The following evening, back in her apartment, she performs the same gesture on her NFC-enabled laptop, which brings up the item in the boutique's online shop. She peruses the 30 reviews, eventually deciding to purchase the scarf.	50
4.11	Copy/Paste. Katja and Henrik are preparing for their presentation en route to the conference. Unfortunately, their short flight does not include WiFi for purchase. When Katja sees that Henrik has written a succinct description of their technical implementation, she gestures on his NFC-enabled laptop to copy the text. She then performs the same gesture on her own NFC-enabled tablet, pasting the text into her copy of the slide deck.	51
4.12	Left, in blue: Notifications. Pierre is anxious to know if his important package has been delivered; however, he has just run into the new headmaster at his son's school, and doesn't want to seem rude by taking out his phone. Instead, he places his hand on his hip, discreetly aligning his TransformatioNail with the phone in his pocket. He flicks his finger downwards, requesting Amazon delivery notifications. A wave of relief washes over him when he glances down and sees the updated display on his TransformatioNail. His package is safe at home. Right, in pink: Settings. When Antonia passes by her daughter's room, she notices that Sofia has fallen asleep reading again. Not wanting to wake her with a voice command, Antonia performs a simple gesture on the smart speaker. The lights dim, a nightlight flickers on, and a faint whisper of waves can be heard emanating from the speaker. Antonia quietly leaves the room as Sofia continues to slumber.	52
4.13	Top: Sample of results from <i>Disparate Digits</i> . Bottom: Sample of results from <i>Unconstrained Use</i>	53
4.14	Participants that placed each function on a given finger in <i>Disparate Digits</i>	54

4.15	Participants that placed each function on a given finger in <i>Unconstrained Use</i> . This figure shows the dominant hand on the right because 14 of the 15 participants were right handed (the left handed participant's data is included, but mirrored so that all dominant hands are on the right). Custom applications included user authentication, payments, the ability to unlock RFID doors, and controlling music.	56
4.16	Aestheticism and Mutability of various body-worn artifacts. NailO [88] and Beauty Tech Nails [192] (shown in dark blue) expand the aestheticism of artificial fingernails to include additional functionalities, but maintain the mutability. In addition to expanding the aestheticism to include additional functionalities, AlterNail and TransformatioNail (shown in yellow) modify the mutability of the form factor, allowing aesthetic changes in a more frequent time frame. Traditional Artificial Fingernails are shown in pink.	61
5.1	Visibility and Interactivity of various body-worn artifacts. Hair (shown in pink) occupies a unique location in the design space as a highly visible and interactive artifact. Most prevalent wearable form factors are shown in dark blue. While clothing, jewelry, accessories, and related artifacts are often visible to both the wearer and onlookers, hair is often only visible to others. In addition to motivating hair as an interesting location for wearable technology, this two dimensional projection of visibility and interactivity highlights an underexplored area for interactive technology with limited visibility.	64
5.2	A) HÄirIÖ prototype prior to miniaturization, B) exemplar HÄirIÖ hair accessory form factors, C) HÄirIÖ uses Swept Frequency Capacitive Sensing to detect natural hair interactions, D) HÄirIÖ color changing properties using thermochromic pigments, and E) shape changing properties using Nitinol wire.	66
5.3	Diagram of a HÄirIÖ braid. The connector at the top of the braid attaches directly to the driver circuit. The Nitinol and copper wires are soldered together at the end of the braid to make a single wire. The thermistor is woven into the braid to ensure accurate readings.	71
5.4	Transition behaviors for a HÄirIÖ braid with a resistance of 2Ω , at three operating currents; smoothed with a low pass filter. Typical worn operation uses a current draw of 1.5A. Photos of the braid in each transition state are of HÄirIÖ braid with a resistance of 2Ω at an operating current of 2.0 A; however, braids at different currents demonstrate similar effects. Note that the insulating properties of the hair affect when transitions occur; the ordering of shape and color events in transition pairs (B,C) and (D,E) switch in the 1.0A case.	73
5.5	Illustration of two subtle notifications. Left: the actuated braid lifts slightly, protruding from the side of the head. Right: the actuated braid shifts into peripheral view. While the user would notice these subtle movements of their hair, onlookers are unlikely to notice the changes, and would likely attribute them to natural hair movement.	75

5.6	Illustration of two social applications of HairIO . Left: interacting with a friend’s HairIO braid could change the color of one of your own braids. Right: Manipulating a HairIO braid could cause a friend’s braid to move in the same way. This application could be used for sending discreet messages during meetings, or for sending haptic messages to someone not collocated.	76
5.7	Physical implementation of application. HairIO braid is twisted around a bun. Upon actuation, the braid begins to straighten out, unwrapping from the bun and falling on the user’s shoulder. A second wire unravels similarly, and the entire bun falls down. This technique also employs haptics, as the hair movement elicits a tactile sensation.	77
5.8	Communicative Reach and Activation of HairIO, Hairware [191], FIRE [185], and unaugmented hair.	83
6.1	Removability and Maintenance of various body worn artifacts. Existing wearable technologies (highlighted in dark blue) are high maintenance, requiring frequent charging, updates, and attention to notifications. Implemented AlterWear artifacts are highlighted in pink.	86
6.2	Visibility and Accessibility (Reachability) of various body-worn artifacts. Shown in pink are implemented AlterWear prototypes; artificial fingernails are co-located with shirt pocket, always accessible and visible to both the wearer and others; both baseball cap prototypes are co-located, always accessible but only visible to others. Shown in dark blue are prevalent wearables. Implantable RFIDs are always accessible, but never visible [101]. While accessible by medical professionals, IUDs are never accessible to the wearer. Locations on the shoe depend on body posture and are therefore “sometimes accessible”. Future work should explore AlterWear interactions in body locations that are never accessible, such as the back of a shirt or jacket.	88
6.3	Three AlterWear prototypes. Note how well the technology is integrated into the garments. Left: Tee shirt pocket display (i.e., pattern). Middle: Segmented hat display (i.e., stars). Right: Discreet sneaker display (i.e., Catverse logo). AlterWear couples energy harvested from an NFC-enabled device with e-ink displays to afford dynamic interactions and expressions without the need for on-board power.	89
6.4	Interaction model for AlterWear displays. Users 1) pick a design using their Smartphone or other NFC-enabled device, 2) tag the device to their display to update it, and then 3) wear their new design without the need to recharge it, update it, or maintain it.	90
6.5	The larger prototypes use an NFC Tag 2 Click breakout board, an Arduino Pro Mini microcontroller, and an e-ink display with EPD Extension Kit. While these components are relatively large and bulky, the size can be significantly reduced with custom hardware (see Figure 4.6).	90

6.6	The AlterWear architecture includes an NFC tag, a microcontroller, and an e-ink display that are powered and updated through contact with an NFC-enabled device. When the device comes into contact with AlterWear, energy and data are transferred via NFC. The NFC tag then powers and transfers data via I2C to the connected microcontroller. Finally, the microcontroller powers and communicates with the e-ink display over SPI.	91
6.7	Pocket tee prototype. Left: name tag application. Right: when the user places their NFC-enabled phone in their pocket, the phone continuously powers the display, and a simple animation is displayed.	94
6.8	Baseball hat prototypes. Left: Hat prototype with AlterWear display on the front panel. Right: Hat prototype with AlterWear display on the side panel. Below: Close up of the side design. This prototype includes a simple animation when updating the display to give the appearance of sparkling or twinkling stars. . . .	95
6.9	Sneaker prototype. Left: Discreet display on the inside heel of the left shoe. Right: Public display on the toe of the right shoe. AlterWear devices are highly contextual. A single artifact can be both personal and public depending on the location of the display.	96
6.10	Disjointed tagging (left) and situated updates (right). Camila is volunteering at her local animal shelter. She tags her phone to the back of her hat to update the display on the front. It now showcases the shelter’s logo. When she returns home, she hangs her hat on an NFC-enabled hat rack, which updates the hat to her default design: her initials.	98
6.11	To demonstrate durability and longevity of AlterWear devices, the fingernail prototype was completely enclosed in resin. The prototype is durable, waterproof, and still entirely functional.	100
6.12	The designed AlterWear prototypes. These prototypes vary in size, form factor, and location on the body. Several of these prototypes are more suited to public applications and displays, whereas others are more subtle and personal.	102
6.13	Example application of a discreet display. The user checks fitness information displayed discreetly on the inside of his heel.	105
6.14	Sociality and Mutability of various body-worn artifacts. AlterWear (shown in yellow) expands both the sociality and mutability of traditional clothing and accessories (shown in pink). Commercially prevalent wearable technologies are shown in dark blue.	108
6.15	Performativity and Consciousness of AlterWear interaction modalities.	109
7.1	Body Location and Contexts of Use for various body-worn artifacts. The diversity of hats contributes to a broad range of contexts of use. Existing wearable technologies are shown in dark blue; hat form factors are shown in pink. Figure is illustrative only, body locations are approximate.	112

7.2	Three interactive hat prototypes. Left: touch sensitive region and public crown display of the fedora prototype. Middle: personal under-brim display of the flap cap prototype. Right: user evaluation of the baseball cap prototype.	116
7.3	The baseball cap used in the gesture elicitation study.	119
7.4	Agreement rates for the 32 referents, arranged by category. The complete set of elicited gestures for Answer Call, Pan Right, and Help are shown in the superimposed boxes; the number in parentheses is the number of participants that proposed a given gesture. Agreement rates of less than 10%, between 10% and 30%, and between 30% and 50% are considered low, moderate, and high agreement respectively [186].	121
7.5	Complete set of gestures proposed by participants for all referents in the gesture elicitation study. Gestures suggested at least 3 times are highlighted in bold; gestures suggested at least 5 times are shown in bold pink.	123
7.6	Classification of 544 preferred gestures in the initial condition (no constraints), 85 preferred gestures in the <i>Hands Dirty</i> condition, and 85 preferred gestures in the <i>Hands Preoccupied</i> condition. In the <i>Hands Preoccupied</i> condition, 1 participant proposed a neuromuscular sensing gesture (<i>Tense Jaw</i>), shown in black on the right.	124
7.7	Consensus gesture set arranged by category and type of gesture.	124
7.8	Agreement rates for the 5 referents repeated under 3 conditions: no constraints, hands dirty but mobile, and hands preoccupied and immobile.	126
7.9	Three hat prototypes. Left: baseball cap prototype. Middle: flat cap prototype. Right: fedora prototype.	128
7.10	The implemented interactive hats included two different classes of ambient displays. Left: personal under-brim display. Right: public crown display.	129
7.11	Hat prototypes capable of sensing touch and head gestures. The baseball cap (top) has ambient displays under the brim and across the crown; the fedora (middle) has an ambient display across the crown; and the flat cap (bottom) has an ambient display under the brim. In all three prototypes, the battery is tucked into the facing on the inside of the crown.	129
8.1	Interaction Modality (inspiration) and Consciousness (input) of various interactions leveraged by skin-worn wearable technologies. Interaction modalities implemented by prior work are shown in dark blue. Lotion-based interaction (shown in pink) occupies a unique location in the design space as an active form of input inspired by body practices.	137
8.2	Lotion Interfaces sense and react to applied lotion. Left: “Skyscraper Skyline” prototype extends the display capabilities of a smartwatch onto the skin. Right: “Lotus Flower” prototype behaves as a fashionable form of personal expression.	138

- 8.3 Interaction model for Lotion Interfaces. Lotio chemical and material architecture is shown below the stages of interaction. a) Lotio functions as a passive display in the dormant state, similar to a traditional temporary tattoo. b) The wearer applies lotion over top of Lotio. c) In response to the applied lotion, one portion of electrochromic ink is connected to power and the other is connected to ground. The applied lotion behaves as an electrolyte, allowing electrons to move from the positive electrode to the negative. The portion of the design connected to power is oxidised and becomes lighter in appearance; the portion of the design connected to ground is reduced and becomes darker in appearance. d) The lotion is absorbed into the skin. Electrons can no longer move between portions of electrochromic ink, and the new coloring is maintained even after power has been removed. 139
- 8.4 Lotio is a dynamic overlay worn on the skin. When lotion is applied, Lotio functions as a computationally-controllable segmented display, with some portions of the design becoming more saturated and darker in appearance, and other portions of the design becoming less saturated and lighter in appearance. Left: Cosmetic “Eyeliner” prototype. Middle: “Lotus Flower” prototype as a public-facing display. Right: “Skyscraper Skyline” prototype as an extension to existing wearables. 144
- 8.5 The fabrication process for Lotio. a) Design electrode shape and layout interconnects. b) Cut the substrate using commercial vinyl cutter. In this case, the paper tape substrate was applied to waxy paper before cutting. c) Remove excess substrate so that only the design remains. d) Apply electrochromic ink to the cut substrate. e) Transfer resulting design using transfer tape to the skin. 146
- 8.6 Left: Visual clarity of user study prototype at 0.5v, 2.5v, 5v, and 10v. There is minimal perceptible difference between varying voltages. Right: Switching and reversion rates (in seconds) of the user study prototype at differing voltages between 0.5v and 10v. 148
- 8.7 Visual clarity of Lotio prototypes with varying densities of PEDOT:PSS. From left to right: (1) baseline visual appearance of Lotio prototypes with no lotion applied; (2) appearance of Lotio prototypes after Aloe Vera has been applied; (3) the left side of each prototype is grounded (the PEDOT:PSS is reduced and becomes darker in appearance); (4) the right side of each prototype is grounded. From top to bottom, 1 layer of PEDOT:PSS to 8 layers of PEDOT:PSS. 149
- 8.8 The prototype used during the user study. Lotio was adhered to an adhesive plastic substrate for simplified application and removal during the user study. Left: the user study prototype being worn. Right: the user study prototype on a white backing. In both images, no lotion has been applied. 150
- 8.9 Skyscraper Skyline prototype. Every other “building” is actuated and darker in appearance. 153

8.10	Henna-inspired embodied data stream. The weekend following her wedding ceremony, Payal admires the henna-based Lotion Interface still visible on her forearms and hands. Applying an essential oil made from rose petals, Payal notices the visual appearance of her Lotion Interface begin to ebb, with portions becoming darker in appearance and other portions becoming lighter in appearance. Payal knows that the visual appearance of her Lotion Interface is tied to the use of her wedding hashtag online, but has no way to concretely interpret the visualization. She appreciates the dynamic nature of the interface, and feels delight in thinking about all of her family and friends that were able to attend the celebration. . . .	155
8.11	Mannequin heads used during the user study to assess visibility on varying skin tones.	157
8.12	Participants' noticeability ratings of varying skin tones (1 = Not noticeable at all, 7 = Very Noticeable). The center of each image (where the dynamic portion is) represents the average noticeability ranking for that skin tone; the width of each image represents the standard deviation. In each of the images, the bottom right portion of the design is darker.	158
9.1	Interactive scarf technology. Scarves are compelling locations for wearable technology because they are highly accessible, frequently removed, and socially acceptable.	163
9.2	Visibility and Rigidity of various body-worn artifacts. Teeth (shown in pink) occupy a unique position in the design space as part of the body that is rigid, but only visible to others. Commercially prevalent wearable devices are shown in dark blue.	165
9.3	Removability and Aestheticism of various teeth-worn artifacts. In this design space, dentures (shown in pink) are versatile as a form factor that can be functional or aesthetic, not removable or frequently removed.	166
9.4	Mutability and Interactivity of various body-worn artifacts. Embedded technology in the form of interactive dentures has the possibility to transform teeth (shown in pink) from static and infrequently modified to interactive and malleable (shown in yellow). Commercially prevalent wearable technologies are shown in dark blue.	167
9.5	Visibility and Aestheticism of various body-worn artifacts. Perfumes & Colognes (shown in pink) occupy a unique location in the design space as a body-worn artifact that is purely aesthetic but neither visible to the wearer nor others. Commercially prevalent wearable technologies are shown in dark blue.	168
9.6	Body Location and Noticeability of various body-worn artifacts. In this projection, noticeability specifically refers to the scent of the body location or wearable artifact. Form factors that have previously been leveraged for olfactory interfaces are highlighted in dark blue.	169

9.7	Noticeability (scent) and Aestheticism of various applications for wearable olfactory interfaces. The role of traditional perfumes and colognes is shown in pink. Applications proposed by prior work are highlighted in dark blue.	170
-----	---	-----

List of Tables

2.1	Parameters related to the characteristics of the body location, form factor, and designed wearable device.	20
5.1	Design Guidelines for hair-based technologies.	68
5.2	Materials used in HÄirIÖ. While the transition temperature of the Nitinol seems high in comparison to the average internal temperature of the human body (37° C/98.6° F), it poses no risk to the user or their hair [73]. Commercial hair straighteners operate between 93.3° C and 204.4° C (200° F and 400° F) [108]. In addition, both the user’s own hair and the hair extension provide a layer of insulation.	70
5.3	Lifting capability of shape changing braids. The Nitinol begins hanging down, actuates to the listed angle, then relaxes to a resting angle of 44° after power is turned off. Braid specifications: 115° transition Nitinol with 0.75mm diameter, trained to a 90° bend; 1.0 Ω; 50cm total braid length (42cm after bend); 4.9g total braid mass. Though this wire is a thicker gauge than the on-head prototypes, transition time behavior and lifting capabilities are comparable.	72
5.4	Qualitative ranking by participants of noticeability of notification interactions, and comfort and safety.	79
6.1	The e-ink display needs to maintain power during the update only. On an Atmel 328p chip, the time required to update the display is 2.4 seconds. The amount of energy that can be harvested varies based on a variety of factors. Voltage and current may change based on the strength of the RF field, the size of the tag antenna, and the distance between the NFC device and the coil.	92
7.1	The list of referents presented to participants grouped by category. Five gestures were repeated under additional conditions (See Table 7.3); these are shown in pink italic.	117
7.2	Participants in both user studies were asked to rate each individual gesture on the above gesture statements. At the conclusion of each study, participants were asked to rate the hat more generally on the above hat statements. All statements in both studies used a 7-point Likert scale.	118

7.3	After participants had completed the 32 gestures, they repeated 5 of those gestures under two additional conditions: hand dirty and hands preoccupied.	120
7.4	Taxonomy of head-based gestures based on 1,428 collected gestures.	127

Acknowledgments

I am incredibly fortunate to have had Eric Paulos as an advisor. His enthusiasm is infectious, and his creativity knows no bounds. Eric's superpower is encouraging his students to discover and forge their own path. As someone who has always had trouble making decisions, this was endlessly frustrating but ultimately rewarding. None of the work presented in this dissertation would have been possible without Eric's guidance and support.

I'm also incredibly lucky to have had such wonderful and inspiring labmates —Cesar Torres, Joanne Lo, Laura Devendorf, James Pierce, Tim Campbell, Kevin Tian, Molly Nicholas, Sarah Sterman, and Katherine Song. Their creativity and passion for research have been inspiring to me in so many ways, and I have loved collaborating on projects, taking breaks for Thai iced teas, and learning about their interests outside of research. I'm grateful for my lively undergrads —Angela Hou and Jenna Wen. Collaborating with them was one of the highlights of my time in graduate school, and I'm so excited for their bright futures in research.

I would also like to thank my co-authors & collaborators —Chris Myers, Kuan-Ju Wu, Bala Thoravi Kumaravel, Tomás Vega Gálvez, Patrick Chiu, Tony Dunnigan, Don Kimber, and TJ Rhodes. I'm incredibly grateful for my internship mentors Scott Carter and Dr. Gavin Miller. To my undergraduate advisors, Joel Hollingsworth and Dave Powell —thank you for years of support and encouragement, and for first introducing me to research.

I am thankful for the support of my committee members —Björn Hartmann, who was my very first advisor at Berkeley during an undergraduate research program, the very program that convinced me to return to Berkeley for my PhD; and Kimiko Ryokai, whose inspirational work on tangible user interfaces has greatly influenced my thoughts on interactivity, consequently shaping the concept of *Heirloom Wearables*; as well as Kris Pister, who served on my qualifying exam committee, and who has been supportive of my research throughout graduate school.

I would like to thank Jean Nguyen, Shirley Salanio, Audrey Sillers, Sheila Humphreys, and the many other staff members that have encouraged and supported me throughout the years. I am also thankful for the Citris Invention Lab, the Jacobs Institute, the Berkeley Institute of Design, and the Berkeley Center for New Media.

I would be nowhere without the support of my family —my parents Bob and Wendy; my grandparents Anita, Karsten, Bob, and Rachel; my siblings Jess and Nate; and my niece, Austen. I'm also grateful for my family-in-law —Jared, Chris Sr., Aileen, Chris Jr., and Bridgid; as well as for my many cousins, aunts, uncles, and the rest of my extended family. I am grateful to my family members in the Bay Area for making the West Coast feel like home —Julia, CJ, Charlotte, Adelaide, Matt, Justin, Chris, and Payal.

To Maggie Payne, my best friend, perpetual roommate, fellow ukulady, and research rockstar —thank you for navigating the entirety of graduate school with me, for inspiring and encouraging me, and for being my person. You are wonderful and magical, and I appreciate you endlessly. To the rest of my Berkeley family, Joe Menke, Josh Achiam, Andreana Rosnik, Rachel Tove-White, Cristina Cuadros, Kel O'Hara, Franco Esqueda, Bryan Smith, and many

others —thank you for all of the game nights, songs at karaoke, rock climbing adventures, and the overall joy that comes from having you in my life.

Finally, I am incredibly lucky to have the support of my husband, Kevin Ryan. To Kevin —thank you for believing in me, proofreading my emails, and helping me brainstorm wacky new wearables. You're a gem and I could not have done it without you.

Chapter 1

Introduction

Wearable technology is the subset of interactive devices that are worn on the body. By being *on the body*, wearables are well suited to a broad range of unique applications beyond other types of mobile devices. Wearables enable immediate access to body based sensing, provide personal and glanceable interfaces, and also play a role in personal fashion due to their public and semi-public visibility.

The first wearable computer was created in 1961: a shoe worn device for predicting roulette [182]. While not physically assembled until the 1960s, wearable devices were envisioned and conceived much earlier, including in the pioneering essay “As We May Think”, written by Dr. Vannevar Bush in 1945.

¹Image credits (left to right): Life Magazine [18]; Steve Mann, from <http://physics.ucsc.edu/people/eudaemons/layout.html>



Figure 1.1: Left: head-worn camera envisioned by Vannevar Bush in 1945; Right: shoe-worn device implemented by the Eudaemons in the late 1970s.¹

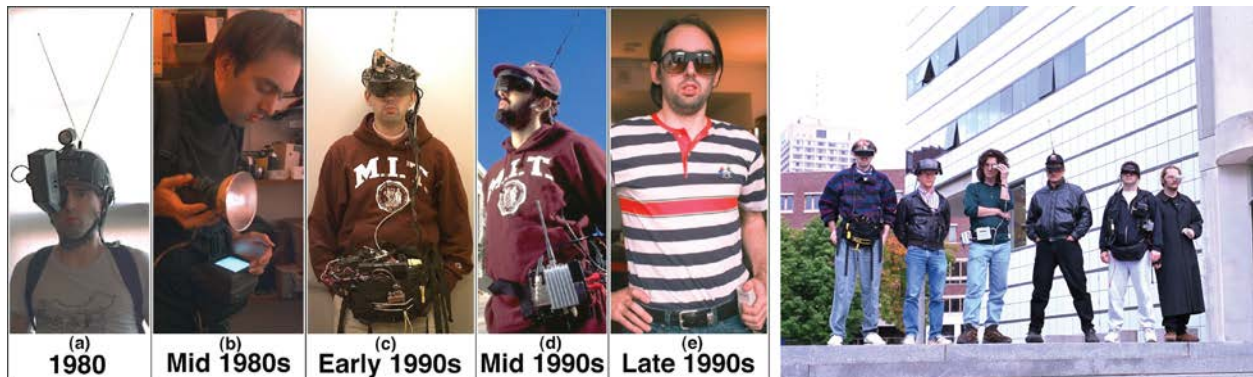

Figure 1.2: Left: Steve Mann pictured with Wearable Computing prototypes from the 1980s to the 1990s; Right: Wearable Computing from the Media Lab at MIT [171]²

The camera hound of the future wears on his forehead a lump a little larger than a walnut... The cord which trips its shutter may reach down a man's sleeve within easy reach of his fingers. A quick squeeze, and the picture is taken [19].

Bush's vision began to materialize in the 1960s with Ivan Sutherland's "head-mounted three dimensional display" [176]. This vision was further realized in research labs throughout the 1980s and 1990s with the iterative design of head-mounted cameras for augmented reality, giving rise to modern wearable computing [171]. More recently, wearable technologies from fitness trackers to networked smartwatches have seen massive growth, adoption, and platform diversification. Recent reports project that the global market for wearable technology will surpass US \$60 billion by 2025 [49, 133].

Trends in wearable technology are simultaneously influenced by manufacturing capabilities, as well as societal interests and desires. The initial emergence of smartwatches, glasses, and other accessories is in part explained by ease of manufacturing rigid components in comparison with soft and flexible materials approximating textiles [11]. These prevalent devices improve our lives in many ways; however, our relationships with them are very different from relationships with traditional body-worn artifacts such as clothing, accessories, and cosmetics. These devices are screen-centric, and function more as discrete devices than as part of the body. They must be removed for certain activities, such as swimming, showering, or sleeping, and require charging on a weekly or even daily basis. Commercial wearable devices require programming and frequent software updates, and default to disruptive, intrusive notifications. This is in stark contrast with our relationships and interactions with traditional body-worn artifacts that are not viewed as discrete devices, but as part of an outfit, a look,

²Image credits (left to right): Steve Mann, from [172]; Presence: Teleoperators and Virtual Environments [171].

or even as part of the body itself. The current landscape of commercial wearable devices misses a lot of opportunities to leverage the affordances of traditional body-worn artifacts.

Device miniaturization and new materials have enabled wearable technology to be integrated more seamlessly with the body, blending in with traditional clothing and accessories and disappearing into the literal “fabric of everyday life” [207]. Wearable technology is no longer limited to wrist-worn forms or glasses-based interactions, or even encapsulated in stand-alone devices. Conductive inks, thermochromic pigments, and other new materials have enabled wearable technologies in the form of temporary tattoos [115, 205, 85, 206], clothing [38, 153, 151], fingernails [192, 88, 175], and makeup [190, 194, 84, 86], among other form factors [82]. Furthermore, developments in the maker community and beyond have begun to democratize the design and development of wearable technology, and new, more diverse and inclusive devices have started to emerge. As these technologies transcend the existing wearable platforms of fitness trackers, smartwatches, and eyeglasses, an entirely novel design ecosystem emerges along with new interaction styles. These new wearable technologies reclaim some of the existing practices and notions of traditional body-worn artifacts, but they’re hard to design and there’s no defined methodology for this category of technology. Inspired by this evolution and my own work within the field, I propose a new class of wearable devices —*Heirloom Wearables*.

1.1 Heirloom Wearables

The Oxford English Dictionary³ provides two definitions for the word heirloom:

1. A valuable object that has belonged to a family for several generations.
2. Denoting a traditional variety of plant or breed of animal which is not associated with large-scale commercial agriculture.

Leveraging both definitions, the positioning of *Heirloom Wearables* is two-fold. (1) *Heirloom Wearables* adopt existing form factors with well-established practices and traditions that are culturally ingrained and have been inherited through generations. These form factors, practices, and traditions are valuable and can inform wearable technologies that are embodied, socially acceptable, and easily adopted, facilitating meaningful interactions and relationships with technology on the body. While existing wearable technologies often allude to established forms (e.g., smartwatches reference wristwatches, data glasses reference eyeglasses), *Heirloom Wearables* propose incorporation of practices and traditions beyond those that are strictly functional or for information purposes. (2) Thus far, *Heirloom Wearables* have not been adopted by large-scale commercial markets. The most commercially prevalent wearable devices have taken existing form factors (i.e., flat, rigid glass screens) and interaction styles (i.e., touchscreens) and simply placed them on or adjacent to the body (i.e.,

³<https://www.oed.com/>

smartwatches). *Heirloom Wearables* offer a different approach, incorporating existing forms, practices, and cultural meaning into the design of new wearable technologies.

Design Framework for Heirloom Wearables

In this thesis, I propose a lightweight framework to facilitate the design of *Heirloom Wearable* technologies. This framework addresses two key research questions.

RQ1. How can the limitations and constraints of body-based technologies be transformed into opportunities for design?

By being *on the body*, wearable technologies are subject to additional limitations and constraints than other forms of technology, including mobile technology. Detailed more thoroughly in the next section, these limitations include physical constraints (size, weight, rigidity, durability), interaction constraints (reachability, removability), aesthetic factors (customizability, visibility), and social considerations (acceptability, sociality). While these limitations restrict the design space for potential wearable technologies, this thesis aims to transform these constraints into opportunities for design. The framework leverages these unique requirements of wearable technology as parameters with which to define a new mapping of existing and potential wearable technologies, identifying interesting and underexplored areas of inquiry.

RQ2. How can body-centric practices inform the design of wearable technologies?

While the body imposes strict requirements that limit potential designs, wearable technology provides new possibilities for leveraging implicit, tacit knowledge of the body [150]. This applies both to the design of interaction modalities, as well as to the design of expressive outputs. In terms of interaction, there exists a rich gesture vocabulary with one's own body: fidgeting, twirling hair, cracking knuckles, biting fingernails, and intimate forms of touch. Technology on the body can leverage these existing gestures, along with their associated mental models, connotations, and cultural meaning. In terms of expression, wearable technologies can leverage the rich histories of body adornment to inform expressive outputs laden with cultural meaning. These outputs have the potential to resonate with existing practices of personal expression and body adornment, speaking to one's individual, as well as group identity. Using the body and its practices as inspiration, designers of wearable technologies can craft meaningful interactions and shape new relationships with technology on the body. The presented framework includes guiding questions designed to surface existing body practices that can be leveraged in the design process.

I address these research questions through a *Design Framework for Heirloom Wearables*, presented in the next chapter. This framework is presented through the lens of Cosmetic Computing and operationalized through the design and development of a broad range of



Figure 1.3: This dissertation discusses the design and implementation of five exemplar *Heirloom Wearable* technologies: fingernail devices, interactive hair, dynamic clothing & accessories, interactive hats, and lotion interfaces. These *Heirloom Wearables* expand the landscape of body-worn technologies.

Heirloom Wearable technologies: fingernail-worn devices, interactive hair, dynamic clothing and accessories, interactive hats, and lotion interfaces.

Cosmetic Computing

Cosmetic Computing is a vociferous expression of radical individuality and an opportunity for deviance from binary gender norms. It is a catalyst towards an open, playful, and creative expression of individuality through wearable technologies. It’s a liberation call across gender, race, and body types. Leveraging the term “cosmetics”, originally meaning “technique of dress”, we envision how intentionally designed new-wearables, specifically those that integrate with fashionable materials and overlays applied directly atop the skin or body, can (and should) empower individuals towards novel explorations of body and self expression. Unlike many modern traditional cosmetics that are culturally laden with prescriptive social norms of required usage that are restrictive, sexually binary, and oppressive [217], we desire a new attitude and creative engagement with wearable technologies that can empower individuals with a more personal, playful, performative, and meaningful “technique of dress” — *Cosmetic Computing*.

The concepts of *Heirloom Wearables* and *Cosmetic Computing* both seek to foster meaningful relationships with technology on the body. *Heirloom Wearable* technology is concerned with the referential characteristics of new wearable devices —what existing practices, traditions, and cultural notions are being referenced, reflected, or remixed? *Cosmetic Computing* technology is concerned with the expressive potential of new wearable devices, particularly those worn directly on the surface of the body. The two concepts are closely related, and several of the exemplar *Heirloom Wearables* were designed and developed through a *Cosmetic Computing* lens. The presented fingernail-worn devices, interactive hair, and lotion interfaces leverage existing cosmetic practices as *Heirloom Wearable* technologies, but also enable new forms of self expression as *Cosmetic Computing* interfaces.

Gender Considerations

As with many technologies, wearable devices have traditionally been designed both for and by men. This is apparent through gendered language and homogeneous representation of potential users. In a “snapshot” sample of 103 wearable products available in 2014 and 2015, Berglund et al. observed a “significant shift towards female-intended audiences” [11]; however, this shift is largely superficial. Instead of incorporating gender considerations throughout the design process, many of these devices simply re-brand existing designs to match stereotypical “female” aesthetics (e.g., “pinking”). While aesthetics are an important characteristic of wearable technologies, Schroeder argues that it is just one of five dimensions to consider when evaluating devices from a gender perspective [162]. The other four identified dimensions are values, functionality, interaction, and communication. The presented framework and concept of *Heirloom Wearables* can be used to inform more inclusive technologies, both in terms of gender and beyond.

1.2 Contribution

This dissertation contributes to a design methodology for expanding the landscape of wearable technologies towards more integrated, embodied implementations that leverage existing body practices and honor cultural notions and traditions. The key contributions of this thesis are the following:

C1. Design Framework for Heirloom Wearable Technologies. The framework is presented as a collection of open questions, organized at multiple levels. I extract parameters from these questions, and use them to map out an illustrative design space of wearable technologies.

C2. Exemplar Heirloom Wearables. In order to operationalize the presented framework, I present several exemplar wearable technologies developed through this lens: fingernail-worn devices, interactive hair, dynamic clothing and accessories, interactive hats, and lotion interfaces.

This design methodology detailed in this thesis provides a roadmap for future designers of inclusive, embodied wearable technologies. This new landscape of devices will blur the distinction between modern wearable technologies and traditional cosmetic practices, fostering meaningful and intimate relationships with technology on the body.

1.3 Outline

This dissertation explores the design and fabrication of *Heirloom Wearables*. The document is organized as follows.

In Chapter 2, I describe existing approaches for the classification and design of wearable technologies. Using these existing approaches, I motivate the need for a new design methodology that explores the affordances of the body independent of technology, emphasizing resulting experiences and relationships over functionality and efficiency. Towards this end, I present a *Design Framework for Heirloom Wearables*. The framework is presented as a collection of open questions, organized at multiple levels. I extract parameters from these questions, and use them to map out an illustrative design space of wearable technologies.

In Chapter 3, I position *Heirloom Wearables* within related research areas of Ubiquitous Computing, Wearable Computing, and Slow Technology. I motivate *Heirloom Wearables* within the context of the expanding landscape of wearable technologies, and discuss related topics of Beauty Technology and Hybrid Body Craft. Chapters 4 - 8 operationalize the framework through the design of several exemplar wearable technologies spanning diverse body locations.

Chapter 4 details exemplar *Heirloom Wearable* technology in the form of artificial fingernails. Worn for several weeks at a time, this body location was chosen to explore the impact of *removability* on the design of *Heirloom Wearables*. In addition, the presented technology highlights fingernails as a unique body location in terms of *size*, *rigidity*, *visibility*, and *accessibility*.

Chapter 5 explores hair as a design material for *Heirloom Wearables*. This highly interactive body-worn artifact was chosen to probe the *interactive affordances* of the body, and highlight how existing gesture vocabularies can be leveraged in interaction design. In addition to identifying hair as a compelling site for technology in terms of *interactivity*, I discuss the unique characteristics of hair in terms of *mutability*, *visibility*, and *sociality*.

In Chapter 6, I highlight *maintenance* as a compelling characteristic of body-worn artifacts, and describe the design and implementation of low-maintenance wearable technology in the form of various clothing and accessories. These prototypes demonstrate how a par-

ticular functionality (low-maintenance dynamic displays) can be embodied in a variety of body-worn artifacts with varying characteristics, including *visibility* and *accessibility*.

Chapter 7 explores the design space of interactive hats to investigate the role of *context* in the design of *Heirloom Wearables*. This exploration leverages the framework to surface differences between hat form factors in terms of *physical form*, *inherent functions*, and *contexts of use*. In addition, hats are highlighted as compelling locations for technology in terms of *visibility* and *social acceptability*.

Chapter 8 introduces Lotion Interfaces as a new *interaction modality* for skin-based technologies directly inspired by *existing body practices*. This new interaction paradigm illustrates how existing *usage patterns* and *social & cultural considerations* can inform and inspire *Heirloom Wearable* technology.

In Chapter 9, I reflect on how the presented framework can inspire additional wearable designs. I present three illustrative designs, a Scarf Interface, Interactive Dentures, and Dynamic Perfume, to demonstrate how the *Design Framework for Heirloom Wearables* applies to three distinct stages of the design process: (1) motivate body location, (2) compare form factors, and (3) highlight opportunities for design. I argue that the framework can be leveraged for inclusive design, and generalized to other design practices such as Internet of Things devices and input technologies.

I conclude in Chapter 10 with a future vision for *Heirloom Wearables* in which relationships with technology on the body more closely resembles relationships with traditional body-worn artifacts, such as clothing and accessories.

1.4 Statement of Multiple Authorship and Prior Publication

This dissertation includes work that was previously published in ACM SIGCHI (AlterNail [40], AlterWear [39]), ACM TEI (HäirIÖ [41]), and ACM DIS (Use Your Head! [42]). As the first author behind each work, I led the research, direction, and writing. However, the ideas, concepts, and artifacts were shaped by the diverse expertise of the Hybrid Ecologies Lab Group including Cesar Torres, Rundong Tian, Molly Nicholas, Sarah Serman, Katherine Song, Chris Meyers, and Kuan-Ju Wu.

Fingernail Devices were designed and fabricated in collaboration with Tomás Vega Gálvez and Balasaravanan Thoravi Kumaravel. For interactive hair, Sarah Serman and Molly Nicholas contributed significantly to design considerations and implementation. Molly Nicholas conducted the user study. Molly Nicholas was instrumental in defining the conceptual space of AlterWear, as well as designing/implementing prototypes and conducting user studies. Sarah Serman and Chris Myers assisted in assembling the exemplar AlterWear prototypes. The core concept of exploring interaction modalities for hat technologies was developed as part of an internship with Dr. Scott Carter, Dr. Patrick Chiu, Tony Dunnigan, and Dr. Don Kimber. With regards to Lotion Interfaces, the system architecture of Lotio was developed

in collaboration with Angela Hou, Jinghua Wen, and Maggie Payne.

My advisor, Professor Eric Paulos, was instrumental in all projects discussed in this dissertation, providing key insights, critique, and directions.

Chapter 2

Design Framework for Heirloom Wearables

2.1 Motivation

Since the advent of smartphones and wearable computers, mobile and wearable technology has continued to proliferate throughout society. While these devices prove beneficial to their owners, they fundamentally change how the user interacts with the world around them. Rather than touching and communicating with the world directly, human interaction is mediated through the use of touch screens and other abstractions. In addition, many of these devices are one-size-fits-all in terms of location on the body, as well as functionality and aesthetics. In an effort to make wearable technology more diverse, personal, and natural, designers and researchers alike have begun to explore additional sites and interaction modalities for wearable technology. Many of these new wearable technologies move away from touch screens to afford more innate interaction. These new interactions include natural hand touches [191], interactions on the skin [93, 115, 85], clothing-based interfaces [153, 151], and beyond [107].

In this dissertation, I aim to inspire and enable embodied wearable devices with a *Design Framework for Heirloom Wearables*. The framework is presented as a collection of open questions, organized at multiple levels. I extract parameters from these questions, and use them to map out an illustrative design space of wearable technologies. These components are intended to guide designers throughout the design process, beginning with ideation and culminating in evaluation. The framework can be used to characterize existing technologies as well as to reveal potential directions for future wearable technologies.

2.2 Existing Approaches

Wearable technologies have been classified and designed using a variety of methods. Berglund et al. surveyed historical and modern wearables to examine device distribution across various

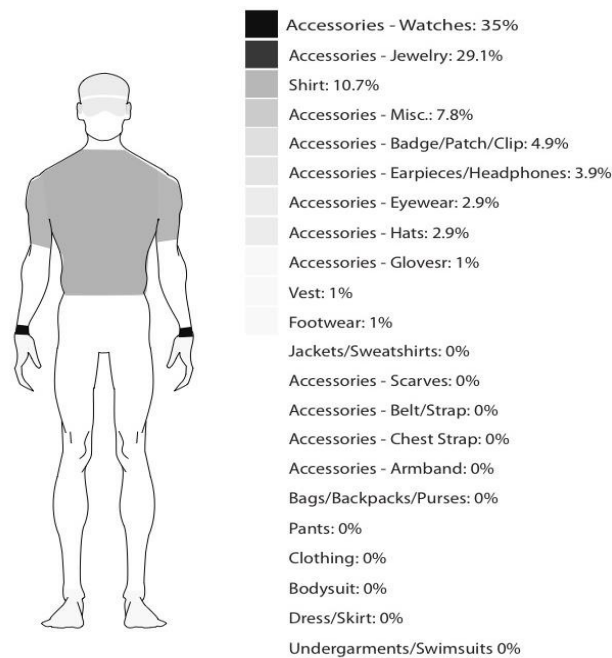

Figure 2.1: Body surface map of the distribution of wearable technologies released or prototyped between February 2014 and April 2015 [11]. A more recent survey of commercially available wearable devices published in 2019 confirms this distribution, with 46% of surveyed devices worn on the wrist [78].¹

body sites, as well as to explore trends in device functionality, product prices, and target gender [11]. Jarusriboonchai and Häkkinen mapped out the design space of wearable technology in terms of customization [78]. There has also been considerable work and theorization on designing for wearability.

Designing for Wearability

In 1998, Gemperle et al. first published design guidelines for wearability, defined as “the physical shape of wearables and their active relationship with the human form” [54]. Guidelines included placement on the body, physical form, human movement, proxemics, sizing, attachment, containment, weight, accessibility, sensory interaction, thermal considerations, aesthetics, and long-term use. Zeagler revisited these guidelines in 2017, updating considerations in light of technological advancements and changing perceptions of wearable tech-

¹Image from: Mary Ellen Berglund, Julia Duvall, and Lucy E Dunne. 2016. A survey of the historical scope and current trends of wearable technology applications. In Proceedings of the 2016 ACM International Symposium on Wearable Computers (ISWC '16). Association for Computing Machinery, New York, NY, USA, 40–43. DOI:<https://doi.org/10.1145/2971763.2971796> [11].

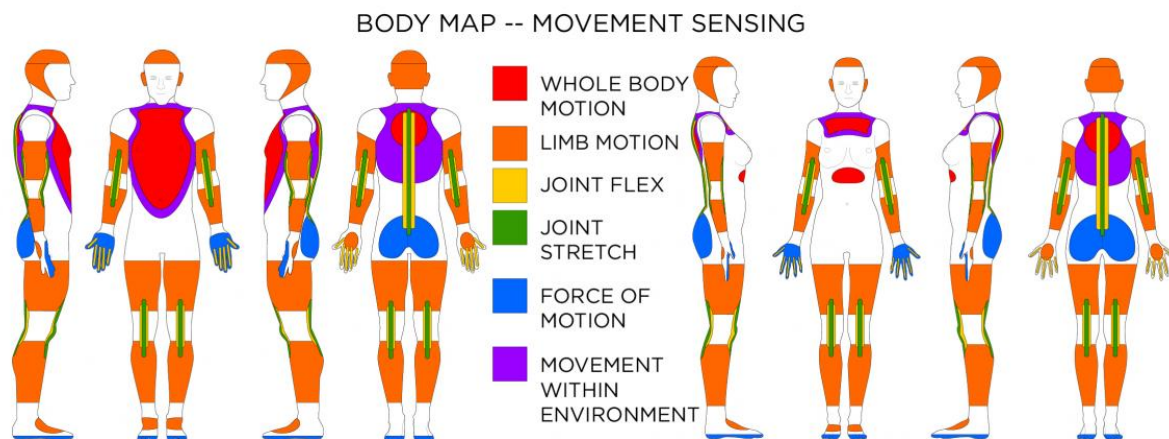

Figure 2.2: Movement Sensor Placement Body Map [225].²

nologies [225]. This work highlights several considerations for appropriate body locations of wearable technology: proxemics, weight distribution, body mechanics & movement, movement sensing, thermal tolerances, biometric sensing, haptic feedback, touch, reach-ability, visible feedback, networking on the body, manufacturing of garments, and social acceptability.

Wearability chiefly addresses *where* and *how* to affix technology to the body; however, as technology continues to become smaller and more lightweight, technology can conceivably be worn *anywhere* on the body and technical constraints dictating the *how* of wearables become less relevant. Notably, wearability does not address *what* technology should be created, nor *why*. While the considerations are useful during development and evaluation, it is unclear how these considerations may be used during ideation, nor how they might inspire new and meaningful engagements with technology on the body.

Technocentric Approaches

Many approaches to wearable technology design first identify desired functionality and sensing capabilities, and then choose a body location and form factor based on technical requirements. In addition to updating Gemperle et al.’s guidelines for wearability, Zeagler provides concrete recommendations for where to place sensors on the body. As an example, here is one of Zeagler’s “Design Considerations for Movement Sensor Placement”:

²Image from: Clint Zeagler. 2017. Where to wear it: functional, technical, and social considerations in on-body location for wearable technology 20 years of designing for wearability. In Proceedings of the 2017 ACM International Symposium on Wearable Computers (ISWC ’17). Association for Computing Machinery, New York, NY, USA, 150–157. DOI:<https://doi.org/10.1145/3123021.3123042> [225].

If trying to capture whole body motion, accelerometers, gyroscopes, and magnetometers should be placed close to the center of gravity on the chest [225].

While this is useful for designers that are specifically trying to capture whole body motion, this approach is limiting. What meaningful interactions with wearable technology may arise when we instead design for the body and its practices and traditions? What new technologies may emerge when instead of focusing on the possible, we focus on the preferable? What affordances of the body are overlooked by this approach?

Many other studies have taken a similar technocentric approach. In 2008, Holleis et al. evaluated various body locations for capacitive touch input, focusing specifically on reachability and social acceptability [67]. The study found that input controls on a trouser, wristband, or bag were deemed socially acceptable, while input controls on a shirt or scarf were not. The study also highlighted a balance between fashion and function, with aesthetics and “personal taste” playing a large role in user perceptions of wearable technologies. In 2009, Harrison et al. conducted an evaluation of appropriate body locations for visual displays [63]. The study evaluated reaction times to visual stimuli at seven different body locations informed by Gemperle et al.’s wearability guidelines: the shoulder, the chest, the upper arm, the waist, the wrist, the thigh, and the top of the shoe. Crucially, the paper positions body locations with poor reaction times (e.g., top of shoe, waist, thigh) not as inappropriate locations for wearable displays, but as an opportunity to “balance the costs of attention demand and distraction”, reserving these body locations for low-urgency alerts (such as a reminder to pick up milk). Introducing a new textile UI element capable of sensing fabric pinches and rolls, Karrer et al. conducted a user study to identify appropriate body locations [91]. The 2011 study found that the forearm, upper arm, hip, pocket, and sternum were most preferred for this specific type of input. Authors also identified key design challenges for smart textiles of wearability, fashion compatibility, durability, and interaction [91].

These works provide a practical guide for where and how to place electronic components and various sensors on the body; however, they offer little guidance as to which wearable technologies should be designed, and what meaningful experiences can be cultivated using technology on the body. In this thesis, I argue that exploring the affordances of the body independent of technology can inspire new, inclusive, and embodied wearable technologies. As technical requirements cannot be ignored, the framework presented in this chapter takes a hybrid approach that addresses considerations for body location & form factor in tandem with technical considerations for the designed device.

Designing for Social Acceptability

In 2014, Dunne et al. expanded the notion of wearability to include social aspects, namely the “influence of the device on the comfort of the wearer’s social experience and identity”, particularly with regards to aesthetics [45]. These social aspects of wearability were drawn largely from results of a 2013 study evaluating the social acceptability of a swiping gesture

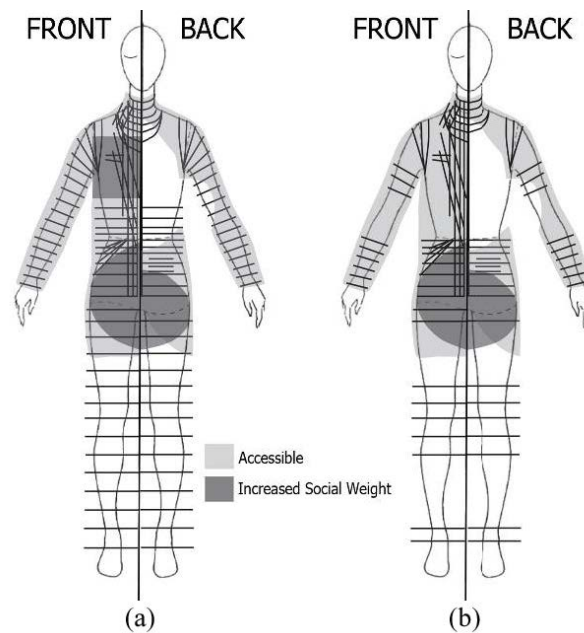

Figure 2.3: Body surface map of garment edges, features, and zones of accessibility and social weight for (a) women and (b) men [45].³

across a badge interface placed at different body locations: the collarbone, the torso, the waist, the forearm, the wrist, and the pocket located near the hip [155]. The study found the wrist and the forearm to be the most preferred locations for gestural input, with participants viewing technology at these locations as unobtrusive, the least “awkward” for interaction, and the most “normal” location for technology. The study found the torso and the collarbone to be the least preferred locations for gestural input, with participants viewing technology at these locations as “unaesthetic”, “inconvenient to access”, and “uncomfortable to view”. Because increased exposure to a particular form factor or concept can increase perceptions of acceptability and adoptability [11], these results were likely heavily biased by existing wearable technologies leveraging the wrist and the forearm (e.g., smartwatches, activity monitors, etc). Furthermore, the study evaluated the same swiping gesture at all body locations, instead of investigating each body location individually to choose an appropriate gesture specific to that body location.

As an alternative approach, Kelly developed the WEAR (WEearable Acceptability Range) scale (See Figure 2.4) [92]. The scale (initially published in 2016) was developed to measure a wearable’s social acceptability, and highlights two driving factors: fulfillment of aspirational

³Image from: L. E. Dunne et al., “The social comfort of wearable technology and gestural interaction,” 2014 36th Annual International Conference of the IEEE Engineering in Medicine and Biology Society, Chicago, IL, 2014, pp. 4159-4162, doi: 10.1109/EMBC.2014.6944540. [45].

The WEAR Scale	Administration and Scoring
<p>Factor 1: Fulfillment of aspirational desires</p> <ol style="list-style-type: none"> 1. I like what this device communicates about its wearer. 2. I could imagine aspiring to be like the wearer of such a device. 3. This device is consistent with my self-image. 4. This device would enhance the wearer's image. 5. The wearer of this device would get a positive reaction from others. 6. I like how this device shows membership to a certain social group. 7. This device seems to be useful and easy to use. 8. This device could help people. <p>Factor 2: Absence of social fears</p> <ol style="list-style-type: none"> 9. This device could allow its wearer to take advantage of people. (R) 10. Use of this device raises privacy issues. (R) 11. The wearer of this device could be considered rude. (R) 12. Wearing this device could be considered inappropriate. (R) 13. People would not be offended by the wearing of this device. 14. This device would be distracting when driving. (R) 	<p>The scale is to be administered to respondents along with photos (or the wearable itself, if feasible) and a description. Photos that show placement on the body should minimize the demographic characteristics of the model. Additionally:</p> <ul style="list-style-type: none"> • The 14 items should be presented in random order. • Respondents are to answer each item according to a 6-point Likert scale: Strongly Agree=6, Agree=5, Somewhat Agree=4, Somewhat Disagree=3, Disagree=2, Strongly Disagree=1 • Items marked with an (R) need to be reversed scored. For example, if the response to #9 was a 5, it should be scored as a 2. • Dividing an individual's score by 14 provides a mean score that ranges from 1 (extremely low social acceptability) to 6 (extremely high acceptability).

Figure 2.4: WEAR scale for predicting social acceptability of wearable technologies [92].⁴

desires and absence of social fears. Notably, Kelly highlights a distinct separation of aesthetic considerations from social acceptability.

While it is important to design wearables that are socially acceptable and desirable, focusing too precisely on acceptability can limit creativity in the design process. As a future direction, Dunne et al. suggest that “on-body interactions can potentially be made less explicit by embedding interfaces that are designed to leverage existing interactions with clothing”, highlighting the affordances of garment features such as pockets, edges, and fasteners [45]. The framework presented in this thesis follows this approach, providing guiding questions to facilitate the exploration of existing interactions and traditions related to diverse body adornments.

⁴Image from: Norene Kelly. 2017. All the world's a stage: what makes a wearable socially acceptable. *interactions* 24, 6 (November + December 2017), 56–60. DOI:<https://doi.org/10.1145/3137093> [92]

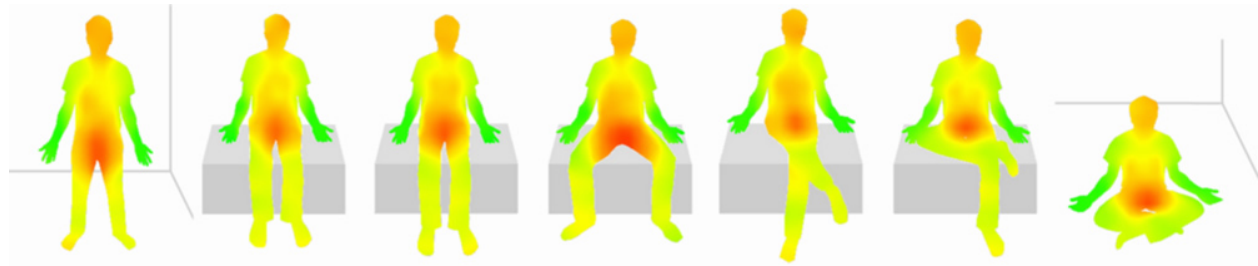

Figure 2.5: Crowdsourced heatmaps conveying comfort (both physical and social) of projected displays at various body locations [62]. Green represents high levels of comfort; red represents low levels of comfort.⁵

Other Approaches

Extending prior work [63], Harrison and Faste explored the appropriateness of various body locations for on-body projected interfaces, evaluating the effects of pose, gender, touching vs. looking (display vs. input), and self vs. others [62]. Addressing the *where* of on-body projected interfaces (See Figure 2.5), the study also engaged experts from relevant fields to address the *why* of such body placement, focusing on informing “more comfortable, efficacious, and enjoyable on-body user experiences”. The 2014 study identified the hands and arms as the most appropriate locations for projected touch interfaces, highlighting key factors of visual & physical accessibility, mobility, gender, and body image. While significant, these findings are limited by the explicit focus on on-body projected interfaces, which leverage traditional forms of input (touch gestures) and output (visual display). How might wearable technologies with more diverse forms of interaction be informed and designed?

Finally, in 2019, Dagan et al. presented a design framework for social wearables, exploring possibilities and opportunities for computation to augment co-located social experience [34]. The presented framework identified two main roles for wearable technology in social situations, to augment existing social signaling or to proactively intervene, and highlighted areas of inquiry for designers of social wearables: sensing, actuating, sensing-actuating interplay, sensing-actuating interplay between wearables, personal & social requirements, and social acceptability.

⁵Image from: Chris Harrison and Haakon Faste. 2014. Implications of location and touch for on-body projected interfaces. In Proceedings of the 2014 conference on Designing interactive systems (DIS '14). Association for Computing Machinery, New York, NY, USA, 543–552. DOI:<https://doi.org/10.1145/2598510.2598587> [62]

2.3 Design Framework for Heirloom Wearables

In this section, I present the *Design Framework for Heirloom Wearables*. This framework draws from existing approaches and has been shaped by my experience in the field, designing and evaluating *Heirloom Wearable* devices. The framework was further developed through the design and implementation of exemplar prototypes, presented in Chapters 4 - 8. In particular, the fingernail-worn devices presented in Chapter 4 revealed insights related to *removability*. The exploration of hair as a design material (Chapter 5) explored the *interactivity* of *Heirloom Wearables*. The dynamic clothing and accessories presented in Chapter 6 informed the role of *usage patterns* in the design of *Heirloom Wearables*, particularly with regards to *maintenance*. The exploration of interactive hats (Chapter 7) revealed insights related to *contexts of use*. Finally, the conceptualization and implementation of Lotion Interfaces further established the role of *usage patterns* within the framework, identifying existing body practices and traditions as inspiration for potential *interaction modalities*. The *Design Framework for Heirloom Wearables* is a reflection on the current design space of wearable technologies, intended to foster critical thinking and to inspire future designs.

This framework takes a hybrid approach that explores both the affordances of the body location and chosen form factor, as well as the technical requirements of the designed wearable device in tandem.

Considerations for Body Location and Form Factor

While existing approaches have considered body locations in light of desired functionality [63, 67, 91], I propose exploring the affordances of the body independent of technology. Designers can approach these guiding questions with a particular form factor in mind (such as a hat, headband, sunglasses, or hairpiece), or simply with a target body location (in this case, the head). Designers targeting a body location (rather than a specific form factor), should approach these considerations while reflecting on the various artifacts worn at the body location.

Physicality

Physicality is most similar to Gemperle et al.'s original notion of wearability and relates to the physical presence of the artifact on the body [54]. What is the size of the artifact? What constrains the size of the artifact —weight, body location, proxemics? What is the shape of the artifact? Is the artifact flexible, rigid, or somewhere in between? Is the artifact or body location accessible (reachable)? Is accessibility (reachability) dependent on certain postures or contexts? What safety concerns are associated with the artifact and body location?

Removability

Removability refers to the frequency at which the artifact is removed from the body. Is the artifact removable? If so, at what frequency —hourly, daily, weekly, or less frequently?

Is the artifact removed during specific activities, such as sleeping or bathing? Are there specific locations the artifact is placed when removed from the body? Is the artifact durable or disposable? Is the interaction temporal in nature?

Mutability

Mutability refers to the frequency at which the artifact is modified or altered. Is the artifact malleable or changeable? If so, at what frequency —hourly, daily, weekly, or less frequently? What form do these changes take —visual appearance, texture, functionality? Are these changes manual or automatic?

Aesthetics

Aesthetics capture the aesthetic characteristics of the artifact. Does the artifact have aesthetic characteristics —is it inherently aesthetic? Is the artifact visible to the wearer —to others? What information is usually conveyed by the artifact —personal expression, group identity? Is the artifact traditionally used for social signaling?

Customizability

Customizability addresses the extent to which the body location and form factor can be customized. Surveying appropriate literature, Jarusriboonchai and Häkkinä define customization as “a possibility for users to modify or adapt technology to meet their needs and preferences” and identify four customization attributes: function, interaction technique, location on the body, and appearance [78]. Is the artifact customizable? If so, in terms of function, interaction technique, body location, or appearance?

Usage Patterns

Usage patterns refer to existing practices and traditions involving the body-worn artifact. What are the existing practices associated with the artifact and/or body location? What interactions and gestures already exist for the form factor or body location? Does the artifact have inherent functions such as protecting from the elements? Does the artifact or body location have different accepted practices depending on context? Is the motivation behind usage intrinsic or extrinsic? At what frequency do interactions occur? How is the artifact maintained? Is the artifact high maintenance or low maintenance? Is the body-worn artifact specific to certain contexts? Is the artifact worn in varying contexts?

Social and Cultural Considerations

Social and cultural considerations attempt to capture social and societal perceptions of the artifact, and the cultural meanings attached to the use of the artifact. Is the artifact socially acceptable? What influences the social acceptability of the artifact —culture, context,

gender, age, or a combination of factors? Are there cultural biases related to the artifact or body location with regards to age, gender, race, or other factors? How do the usage patterns of the artifact vary depending on examined culture? What social weight [184] does that artifact have? Does the artifact encourage or prevent social interactions? What is the communicative reach of the artifact? Does it extend beyond the limits of human perception? What traditions exist with regards to the artifact?

Considerations for Designed Wearable Device

The above considerations for body location and form factor probe the affordances of the body independent of technology. Towards a holistic design methodology for wearable technology, this framework proposes the simultaneous consideration of technical requirements for the designed wearable device. These considerations for designed wearable device are intimately interconnected with the above considerations for body location and form factor.

Power Source

Power is a prevalent technical requirement for all forms of technology, and thus a key design consideration for wearable technologies. While component miniaturization and new materials have enabled wearable technology to integrate more seamlessly with the body, batteries and other power supplies remain bulky, rigid, and put responsibility on the user to maintain and charge. Designers should take extra care in determining the power source for the designed wearable device, considering opportunities for wireless charging and energy harvesting. Is the artifact large enough to hold a battery? Is the artifact rigid enough to support a traditional battery? Is the artifact frequently in contact with other devices, surfaces, or objects? Are there locations in which the artifact is frequently placed?

Expressive Output

Wearable technologies often have expressive outputs used for communication to both wearers and onlookers. These outputs can take many forms, including visual displays, tactile feedback, audio, and olfactory outputs. Are there sensing modalities specific to this body location? What fidelity of information can be displayed or communicated at the size of the artifact? Are the display elements visible or perceptible in the powered off state? Is the output aesthetic in nature? Are there opportunities for bistability? Is the output reversible? Are there privacy concerns at this body location? Is the expressive output performative or inconspicuous? What is the impact and persistence of the output? Is the output ambient or immediately noticeable?

Sensing

Compared with other forms of technology, wearable devices provide privileged access to body-based sensing. In addition, technology on the body can communicate with external

	Consideration	Parameters
Body Location and Form Factor	Physicality	size, rigidity, weight, accessibility (reachability)
	Removability	removability, durability, temporality
	Mutability	mutability, modality, intentionality
	Aesthetics	aestheticism, visibility, noticeability
	Customizability	customizability, modality
	Usage Patterns	interactivity, motivation, inherent functions, frequency of interactions, maintenance, contexts of use
	Social & Cultural Considerations	universality, social acceptability, social weight, sociality, communicative reach, traditions & accepted practices
Designed Wearable Device	Power Source	consumption & generation, tolerance for intermittent power
	Expressive Output	modality, fidelity, performativity, impact, stability, visibility, noticeability, aestheticism, privacy
	Sensing	modality, source (internal sensors, external devices)
	Interaction Modalities	input modality, consciousness

Table 2.1: Parameters related to the characteristics of the body location, form factor, and designed wearable device.

systems (e.g., smartphones, smartwatches, smart environments) to discern user activity and related data. Are there sensing modalities specific to this body location? Is the body location well suited to a particular type of sensor? Is the artifact frequently in contact with other devices surfaces or objects? Are there opportunities to infer context at this body location by using sensors or communicating with external devices?

Interaction Modalities

A key design consideration for any technology is how the user interacts with the device. This is especially relevant for on-body interfaces, as users already have established gesture vocabularies with their own body. How is the device activated? Is input explicit or implicit; active or passive? What form of input is appropriate for the proposed functionality —touch input, proxemics, gaze, biometrics? Is the device liable to accidental triggers and false positives?

Parameters of Body Location, Form Factor, and Designed Wearable Technology

Using the considerations outlined above, I extract parameters related to the characteristics of the body location, form factor, and designed wearable device. These parameters are shown in Table 2.1 and can be used to inform morphological design space analysis [81, 21]. Traditional body-worn artifacts and existing wearable technologies can be viewed as points in a parametrically described design space, highlighting opportunities for future developments. Here, I present a two dimensional projection of selected parameters. These illustrative

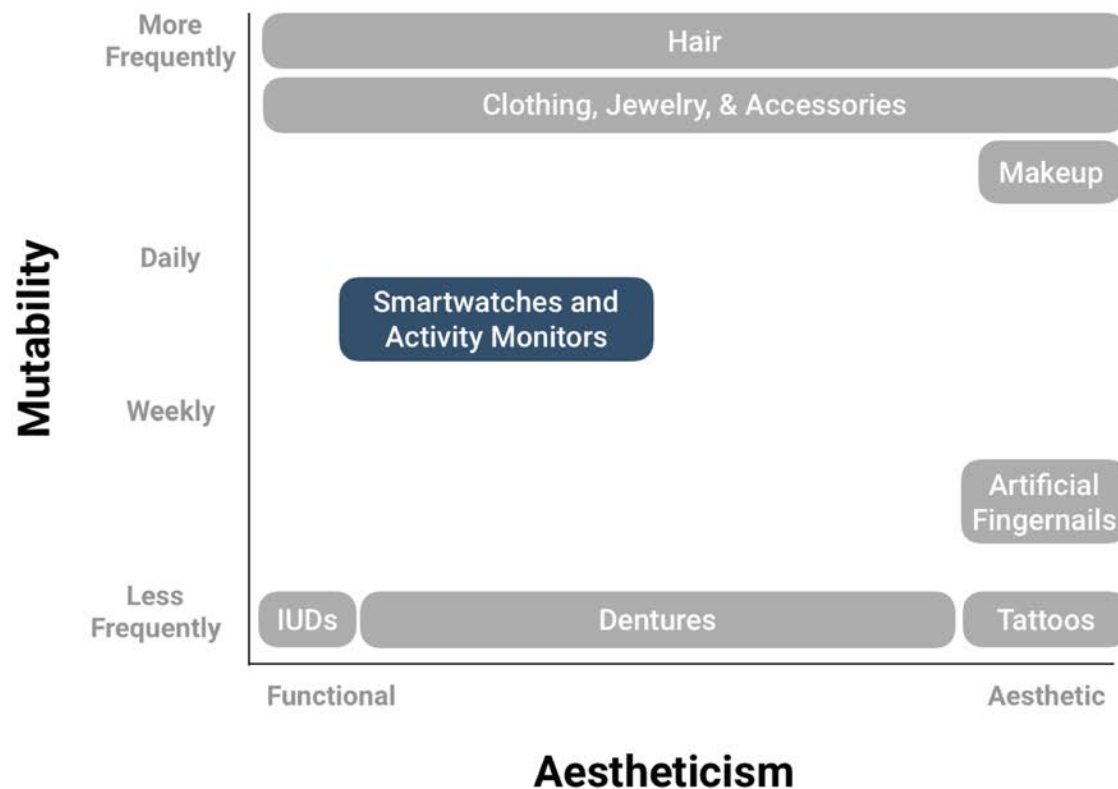

Figure 2.6: Aestheticism and Mutability of various body-worn artifacts. Commercially prevalent wearable technologies are highlighted in dark blue.

figures represent a few interesting comparisons and do not attempt to communicate the vast diversity of existing body adornments and wearable technologies.

As an example, Figure 2.6 shows a two dimensional projection of the *mutability* and *aestheticism* of various body-worn artifacts. In terms of *mutability*, artifacts such as intrauterine devices (IUDs), dentures, and tattoos are relatively immutable. After placement on or inside the body, the artifact remains unchanged for long periods of time. In terms of *aestheticism*, however, these three artifacts vary considerably. IUDs are purely functional and have no aesthetic qualities; tattoos are purely aesthetic (with the exception of social signaling of one’s personal and group identity); dentures are equally functional and aesthetic. Having both functional and aesthetic qualities, hair, clothing, and accessories have more frequent mutability. At a minimum, clothing and hair are styled daily; however, changes are often more frequent. Sleeves are rolled or pushed up; hoodies are zipped and unzipped; makeup is retouched or smudged; hair is pulled back, let down, or tousled.

Alternatively, Figure 2.7 illustrates a two dimensional projection of *mutability* and *removability* of the same body-worn artifacts. Although related, *mutability* and *removability*

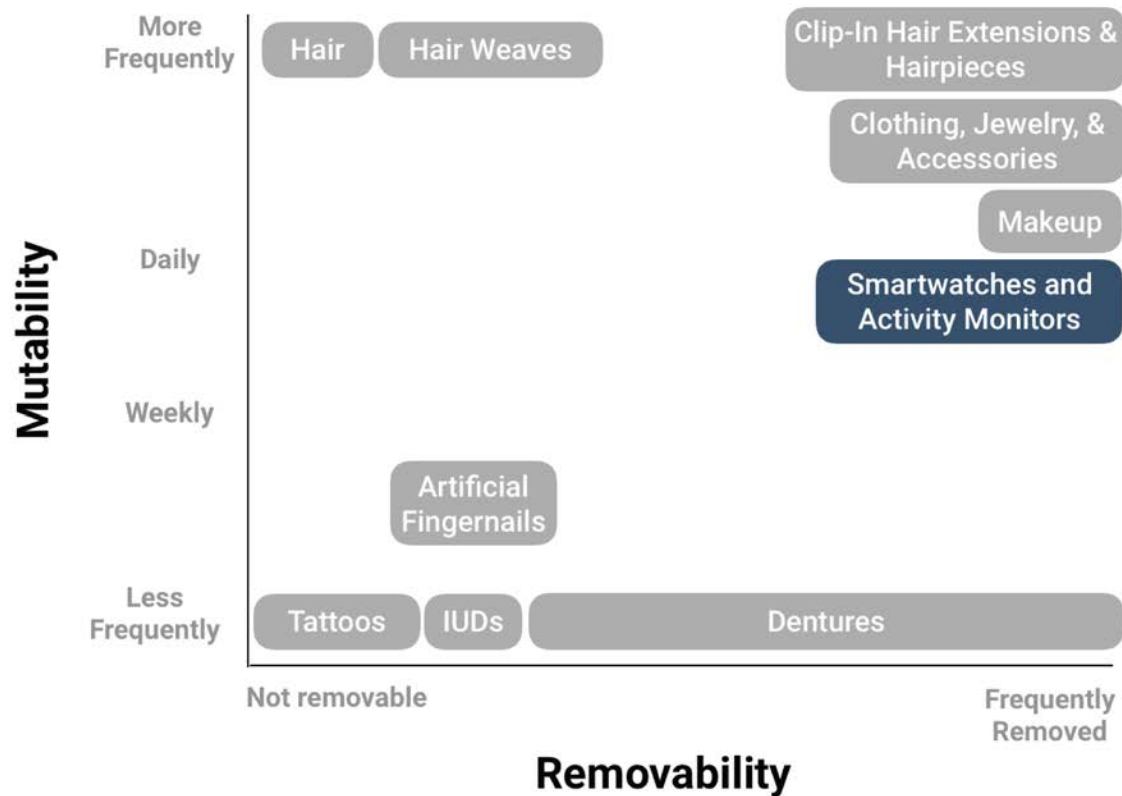

Figure 2.7: Removability and Mutability of various body-worn artifacts. Commercially prevalent wearable technologies are highlighted in dark blue.

are distinct characteristics. Clothing, accessories, and makeup are modified and removed at similar frequencies. However, hair (while modified and restyled at a similar frequency to clothing) diverges in terms of *removability*. Clip-in hair extensions and hairpieces are treated similarly to accessories and typically removed on a daily basis; hair weaves are more permanent and last for months or years; although commonly cut or shaved, natural hair is never truly removed. Sharing infrequent mutability, IUDs, dentures, and tattoos vary in terms of *removability*. While tattoos can be removed, it is difficult and painful to do so. IUDs can be removed by a doctor at any time, but are intended to last for several years. Depending on needs, dentures can either be fixed (only removable by a dentist) or easily removable and done so on a daily basis.

As another example, Figure 2.8 shows a two dimensional projection of the *visibility* and *aestheticism* of the same body-worn artifacts, adding in glucose monitors as well as perfumes and colognes to illustrate the design space. Depending on body location, tattoos can be visible to others only, both the wearer & others, or the wearer only. To illustrate its unique placement within the design space, I highlight the potential for tattoos to be aesthetic body

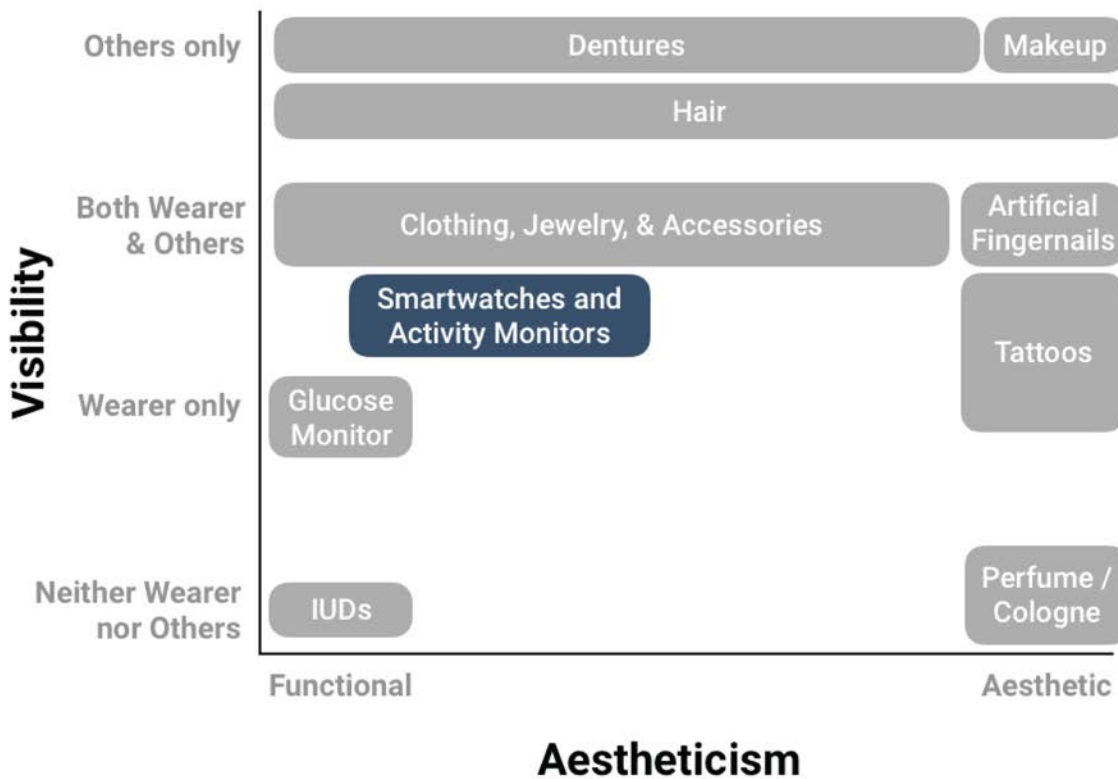

Figure 2.8: Aestheticism and Visibility of various body-worn artifacts. Commercially prevalent wearable technologies are highlighted in dark blue.

adornments intended to be visible to the wearer only. This includes tattoos in private body locations that are not intended to be revealed to others. These figures are illustrative only, an artifact’s location within a given projection depends heavily on context, culture, and other external factors.

2.4 Summary

Wearable technologies have been classified and designed using a variety of methods. These methods include designing for wearability, technocentric approaches, and designing for social acceptability, among other approaches. Existing approaches often address *where* and *how* to affix technology to the body without addressing *what* technology should be created, nor *why*. While the existing approaches are useful during development and evaluation, it is unclear how these considerations may be used during ideation, nor how they might inspire new and meaningful engagements with technology on the body. Furthermore, focusing too precisely

on wearability, desired technical functionality, or social acceptability can limit creativity in the design process, causing affordances of the body to be overlooked.

Summarized in Table 2.1, the *Design Framework for Heirloom Wearables* provides an alternative approach: exploring the affordances of the body independent of technology while simultaneously considering the technical requirements of the designed wearable device. The framework includes guiding questions organized at multiple levels, from which I extract parameters defining the space of body-worn artifacts. These parameters can be used to map out the space of existing body adornments and wearable technologies, as well as to highlight underexplored areas and opportunities for future developments.

In subsequent chapters, I demonstrate the value of this framework as applied to a number of different wearable technologies, spanning diverse body locations. In particular, I leverage the parameters of the framework to motivate body location, compare form factors, inform input modalities, navigate constraints, and highlight opportunities for design. These technologies and the framework were developed contemporaneously, and each contribution has benefited immensely from the other. In particular, the exemplar prototypes were designed to explore and expand certain parameters of the framework. Fingernail-worn devices were developed to explore *removability*. Interactive hair was chosen to investigate *interactivity*. The dynamic clothing and accessories presented in Chapter 6 focus on *maintenance* as a theme. Interactive hats explore the role of *context* in the design of *Heirloom Wearables*. Finally, Lotion Interfaces demonstrate *interaction modalities* directly inspired by *existing body practices*.

Chapter 3

Related Work

3.1 Ubiquitous, Wearable, & Slow Computing

This dissertation takes inspiration from the fields of Ubiquitous Computing, Wearable Computing, and Slow Technology. Giving rise to the field of Ubiquitous Computing, Mark Weiser famously argued that “the most profound technologies are those that disappear. They weave themselves into the fabric of everyday life until they are indistinguishable from it” [207]. This vision proposed technology seamlessly integrated into everyday objects, with “hundreds of computers per room” rendering environments smart and computing pervasive. While device miniaturization and the Internet of Things have brought computing to new domains, the vision of truly ubiquitous computing remains elusive even now, almost 30 years from its origin. Taking a different approach, Wearable Computing applies the vision of ubiquitous computing to the body, augmenting the user rather than the physical environment. Starner et al. envisioned Wearable Computing as an “effective way to gain the benefits of ubiquitous computing with a sparse infrastructure” [171]. Since their inception, wearable technologies have seen massive growth, adoption, and platform diversification. Recent reports project that the global market for wearable technology will surpass US \$60 billion by 2025 [49, 133].

In contrast with these initial goals of Ubiquitous and Wearable Computing, Slow Technology represents a transition away from efficiency and performance towards meaningful experiences [59]. Commercially prevalent wearable technologies (e.g., smartwatches, activity monitors, data glasses) have been driven by performance, focusing on making data and functionalities ever-present and ever-available, more readily accessible to the wearer. Rather than providing more efficient access to functionalities and data available on Smartphones and other devices, I propose designing wearable technologies to foster new experiences altogether. Focusing on meaningful experiences over functionality and efficiency, *Heirloom Wearables* explore how technology can be seamlessly integrated with the body and its practices.

3.2 Expanding Landscape of Wearable Technologies

Device miniaturization and new materials have enabled wearable technology to be integrated more seamlessly with the body. While some of these emerging wearable technologies have introduced new form factors to the landscape of body-worn artifacts (e.g., Head Mounted Displays), many instead leverage existing form factors. In this section, I detail this category of technologies, discussing wearables in the form of clothing, accessories, skin-worn artifacts, and cosmetic form factors.

Clothing

Clothing is a compelling location for wearable technology in its proximity to the body and ubiquity. However, this closeness to the body subjects wearable technology in this form to additional requirements regarding wearability (e.g., size, rigidity, and durability, among others).

The Printing Dress [169] is a performative wearable device that reflects on the past, present, and future of communication media. A capacitive keyboard embedded into the corset allows both the wearer and others to input text which is then projected onto the skirt. Mainly developed to probe perceptions of on-body touch gestures, Holleis et al. designed and evaluated wearable technology in the form of an apron with embedded buttons for touch input [67]. SensorSnaps leverage small, rigid parts of clothing (i.e., snap fasteners) as locations for embedded electronics, augmenting garments with gesture recognition, wireless connectivity, motion tracking, and touch sensing [35].

Wearable technology has also been embraced by the fashion industry, particularly expressive and performative garments that have high visual impact on the runway or stage. Focusing on LED clothing and accessories, Cute Circuit¹ has successfully commercialized fashionable wearable garments. MakeFashion² (est. 2013) is a fashion-tech collective originally envisioned to “elevate wearable technology to the runway”. The collective produces several avant-garde runway shows per year, and has launched a ready-to-wear line, Lumen Couture³. Similar to Cute Circuit, the majority of MakeFashion garments feature emissive light displays (e.g., LEDs), due to their visibility on the runway [165]. Designed to support such fashion-driven wearable technologies, Seyed and Tang presented Mannequette: a prototyping tool for avant-garde fashion-tech garments [165]. These works have explored the integration of traditional electronic components (e.g., PCBs, wires, etc) within wearable garments.



Figure 3.1: E-textiles: (a) Vilkas dress with kinetic nitinol hemline; (b) embroidered fabric keypad with composite image of attached circuit board; (c) Ebb thermochromic textile display; (d) Levi’s[®] Commuter X Jacquard By Google trucker jacket⁴.

E-textiles

An alternative approach is to embed the electronics within the textile itself, as e-textiles (See Figure 3.1). Unsupported by electronics manufacturing methods, e-textiles commonly leverage traditional textile manufacturing and fabric manipulation techniques including sewing, crocheting, weaving, felting, quilting, embroidery, and beyond.

Post and Orth implemented electronic circuits composed of textiles; these circuits leveraged traditional materials (e.g., metallic silk organza, conductive yarns, gripper snaps) and were demonstrated as musical keyboards and input surfaces [151]. Extending this work, Orth et al. embedded fabric computing interfaces in articles of clothing, presenting three “smart fashions”: the Musical Jacket, the Firefly Dress, and the Electronic New Year’s Eve Ball Gown [139]. The Musical Jacket includes an embroidered keypad (Figure 3.1, b); when touched, an embedded MIDI synthesizer generates musical notes. The Firefly Dress features a dynamic lighting effect as embedded LEDs brush against layers of conductive fabric connected to power and ground. The Electronic New Year’s Eve Ball Gown uses decorative conductive embroidery to connect touch sensors and LEDs, enabling touch reactive aesthetics. These works led to the introduction of e-broidery: durable, flexible, and washable embroidered textile circuitry [152].

Kukkia and Vilkas (Figure 3.1, a) are kinetic electronic garments designed for playful fashion and personal expression; shape memory alloy Nitinol embedded in textile substrates empower dresses with animated flowers and moving hemlines [13]. Memory Rich Clothing senses and displays traces of physical memory, or “histories of use” [12]. Memory Rich Cloth-

¹<https://cutecircuit.com/>

²<http://www.makefashion.ca/>

³<http://www.lumencouture.com/>

⁴Image credits. (a) Photo by Shermine Sawalha. Image from: Berzowska and Coelho. 2005. Kukkia and vilkas: Kinetic electronic garments. ISWC ’05 [13]. (b) Image from: Post et al. 2000. E-broidery: Design and fabrication of textile-based computing. IBM Systems journal. [152]. (c) Image from: Devendorf et al. 2016. “I don’t Want to Wear a Screen”: Probing Perceptions of and Possibilities for Dynamic Displays on Clothing. CHI ’16 [38]. (d) Levi Strauss & Co, from [109].

ing is demonstrated through three exemplar prototypes: Intimate Memory, Pure Play, and Touch Memory. The Intimate Memory outfit utilizes input from soft switches and an embedded microphone to control LEDs and call attention to “intimacy events”. The Pure Play tunic leverages thermochromic ink to initiate a conversation between physiological and computational input on the body, visualized through a color-changing neckline. Touch Memory dresses explore social choreographies of touch and embodied intimacy, using thermochromic “spots” and touch-controlled LEDs to enhance and encourage physical touch.

Originally requiring expert knowledge and access to specialized materials and manufacturing processes, the creation of e-textiles was democratized through the introduction of the LilyPad kit in 2008 [16, 17]. The LilyPad kit includes modules that can be easily sewn to fabric and each other via conductive thread. Commercially available and accessible, LilyPad simplified previously complex interfacing between soft and rigid components. Leveraging the LilyPad, Karrer et al. designed a new textile UI element capable of sensing fabric pinches and rolls: Pinstripe [91]. Allowing eyes-free, continuous value input on smart garments, Pinstripe is just one example of many e-textiles enabled through the LilyPad.

In 2016, Project Jacquard presented new materials for creating electronic textiles at scale [153]. Leveraging this new Jacquard technology, Devendorf et al. introduced dynamic textile displays composed of conductive threads coated in thermochromic paint [38]. When powered, resistive heating causes the textile display to gradually change color (Figure 3.1, c). Numerous swatches demonstrate various ways to craft the displays through traditional techniques of weaving and crocheting. Using a similar implementation, Howell et al. explored ambiguous textile displays of skin conductance and highlighted the potential for biosignals to be used as nonverbal social cues [69, 70]. Levi’s® Commuter X Jacquard By Google trucker jacket [109] includes embedded technology in the form of a Jacquard snap tag, as well as interactive threads in the sleeve for touch input (Figure 3.1, d). The jacket communicates with a paired mobile app enabling music control, navigation, and communication capabilities.

Accessories

Wearable technologies in the form of accessories are the most prevalent in commercial markets [11]. The prevalence of this class of wearable technologies may in part be explained by the relative rigidity of accessories (in comparison with textiles) that allow for easy integration of electronic components. Accessories are also ubiquitous, and have lower requirements in terms of maintenance; they are not subject to the same physical stresses as clothing and do not need to be laundered or cleaned as frequently. In addition, accessories are highly removable, making it easier to incorporate batteries and charging routines. Commercial wearables most commonly take the form of wristbands (e.g., FitBits⁵), watches (e.g., Apple Watch⁶), and eyeglasses (e.g., Google Glass⁷) (See Figure 3.3). As with clothing, commercial markets have adopted high fashion accessories with embedded LEDs, fiber optics, and other

⁵<https://www.fitbit.com/>

⁶<https://www.apple.com/watch/>

⁷<https://www.google.com/glass/>



Figure 3.2: High Fashion expressive accessories. Left: fiber optic Louis Vuitton Keepall; Middle: Cute Circuit Mirror Handbag; Right: Lumen Couture LED Matrix Face Mask⁸.

expressive outputs (See Figure 3.2). These eye-catching accessories include LED handbags [126], fiber optic bags & sneakers [117], and LED face masks [105].

In addition to designing an apron, Holleis et al. embedded capacitive buttons in gloves, phone bags, and a bicycle helmet [67]. Profita et al. designed and created LightWear: light-emitting wearable technologies that administer light therapy for treatment of Seasonal Affective Disorder [156]. Augmenting accessories, LightWear prototypes take the form of eyeglasses, scarves, hoods, and hats. Kao et al. designed and created Kino, kinetic accessories enabling dynamic fashion [87].

Jewelry

Observing strict requirements of size and aesthetics, wearable devices in the form of jewelry often serve as extensions to other mobile and wearable technologies (e.g., smartphones, smartwatches). A subset of these devices are used exclusively for input. Nenya is a magnetic ring whose position and rotation can be tracked by wrist-worn electronics (e.g., a smartwatch), enabling always available, subtle, and eyes-free input [6]. Arora et al. define a design space of jewelry-enabled input techniques, highlighting alternative input modalities for external devices [5]. Jewelry form factors have also been leveraged as a location for embedded sensors. The Oura smart ring embeds various sensors in a lightweight form factor, tracking activity, sleep, and “readiness”⁹.

Wearable devices in the form of jewelry have also been used for output, again frequently serving as extensions to mobile and wearable technologies. Prior work has demonstrated ambient LED bracelets for subtle notifications [61], augmented group chat interactions [212],

⁸Image credits. Left: Louis Vuitton. Middle: Cute Circuit, from [126]. Right: Lumen Couture, from [105]

⁹<https://ouraring.com/>



Figure 3.3: Commercially prevalent wearable technologies in the form of accessories. Left: Ringly notification ring; Middle: Apple Watch smartwatch; Right: Google Glass data glasses¹⁰.

communicating spatial proximity of friends [1], and encouraging healthy fluid intake [50]. Ringly¹¹ brings mobile notifications and alerts to smart rings and bracelets (Figure 3.3, left). Ringly devices merge common wearable outputs (vibration and LEDs) with traditional jewelry materials and aesthetics (gems and precious metals). Leveraging a different form of expressive output, Amores and Maes designed Essence, an olfactory necklace that pairs with mobile devices to computationally release scent [2].

In addition to serving as peripheral devices, wearable technologies in the form of jewelry have also been designed to operate independently of existing mobile and wearable devices. Miner et al. explored deconstructing traditional mobile devices and distributing functionality across the body in jewelry-inspired form factors [125]. This vision included expressive output in the form of LED rings, LCD bracelets, and speakers embedded in earrings, as well as input through touch gestures performed on the jewelry surfaces and a microphone embedded in a necklace. Versteeg et al. motivate the role of jewelry, memory, and interaction perspectives in the design of wearable technology and present three conceptual designs for interactive jewelry: a low resolution camera ring, a locket for storing audio recordings, and a hard drive in the form of a pendant [196].

Body Surface Computing

Wearable technologies have extended beyond clothing and accessory form factors onto the body surface itself. Recent advances in materials and fabrication methods have enabled the creation of a wide range of skin-worn technologies. These interfaces on the surface of the skin provide new methods of always-available input [205, 115], biomedical sensing [195, 119],

¹⁰Image credits. Left: Ringly, from <https://ringly.com/>. Middle: fancycrave1, from https://commons.wikimedia.org/wiki/File:Apple_Watch-.jpg. Right: Antonio Zugaldia, from https://commons.wikimedia.org/wiki/File:Google_Glass_detail.jpg.

¹¹<https://ringly.com/>

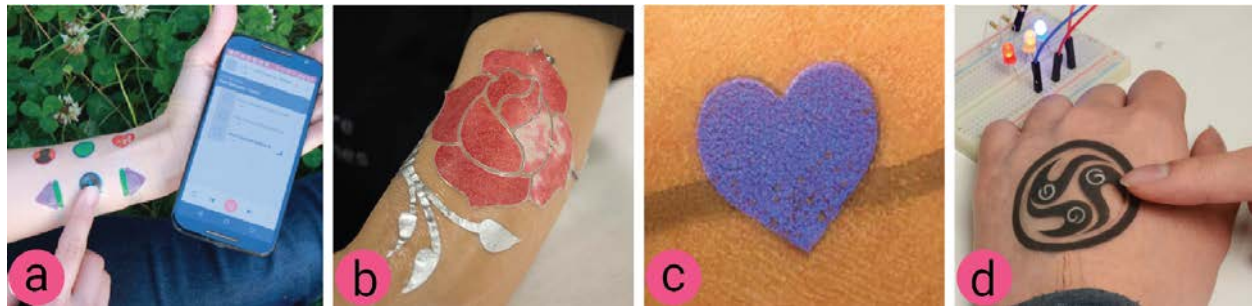

Figure 3.4: Skin-worn interfaces leveraging temporary tattoo form factors and skin-worn silicone overlays. (a) touch input enabled through Skintillates; (b) color-changing DuoSkin interface; (c) electroluminescent SkinMarks display; and (d) touch input enabled through AnimSkin¹².

personal expression [115, 84], and beyond. These prior works have taken the form of silicone overlays [201, 205, 209], temporary tattoos [85, 115, 206, 215], and electronic bandages [119], and have implemented capacitive sensing [85, 115, 201, 205, 206, 209, 135], resistive sensing [115, 205], bend sensing with strain gauges [115, 206], and sensing via embedded sensors [119]. These sensing techniques equip the user with new forms of always available input, and enable novel types of body engagement such as posture sensing [115] and wound monitoring [119]. Prior work on skin-worn technologies have also implemented expressive outputs using LEDs [115, 119], thermochromic pigments [85, 201], and electroluminescent (EL) materials [206, 209] on the surface of the skin.

iSkin [205] introduced silicone overlays enabling touch input on the surface of the skin. Expanding this approach, Stretchis [209] incorporated touch input, proximity sensors, and electroluminescent displays in stretchable silicon-based substrates that could be worn on the skin. Skintillates [115] presented a DIY methodology for fabricating temporary tattoo electronics, demonstrating LED displays, capacitive & resistive sensing, as well as strain gauges for posture detection (Figure 3.4, a). Featuring a similar methodology, SkinMarks [206] focused on enabling temporary tattoo electronics with high conformity and precise localization on the body (Figure 3.4, c). To this end, SkinMarks leveraged thin, stretchable materials and explored electroluminescence as an additional output modality for temporary tattoo-based technologies.

A number of skin-worn technologies have leveraged thermochromic and other materials to enable color-changing interfaces on the surface of the skin. AnimSkin [201] is a silicone

¹²Image credits. (a) Image from: Lo et al. 2016. Skintillates: Designing and Creating Epidermal Interactions. DIS '16 [115]. (b) Image from: Kao et al. 2016. DuoSkin: rapidly prototyping on-skin user interfaces using skin-friendly materials. ISWC '16 [85]. (c) Image from: Weigel et al. 2017. SkinMarks: Enabling Interactions on Body Landmarks Using Conformal Skin Electronics. CHI '17 [206]. (d) Image from: Wang et al. 2017. AnimSkin: Fabricating Epidermis with Interactive, Functional and Aesthetic Color Animation. DIS '17 [201].



Figure 3.5: Wearable technologies leveraging cosmetic form factors. From left to right: Beauty Technologies in the form of (a) hair extensions and (b) conductive makeups; Hybrid Body Crafts in the form of (c) nail-mounted electronics and (d) cosmetic chemical sensing powders¹³.

overlay enabling capacitive touch input and color-changing output on the surface of the skin, leveraging PET-ITO and thermochromic pigments in a multi-layer structure (Figure 3.4, d). DuoSkin [85] introduced a fabrication process transforming gold leaf and thermochromic pigments into functional and aesthetic skin-worn interfaces enabling touch input, color-changing output, and wireless communication (Figure 3.4, b). ChromoSkin [84] embedded similar technology in a cosmetic eye-shadow form factor, demonstrating color-changing makeup. These skin-worn devices use thermochromic pigments and resistive heating circuits to enable active color-changing displays. As another approach, prior work has examined passive skin-worn displays that change color in response to external or environmental factors. EarthTones [86] presented chemical sensing eye-shadows that change color with exposure to carbon monoxide, UV light, and ozone. Project Calico [118] embedded photosensitive chemicals into wearable stickers to measure and reflect UV exposure on the surface of the skin.

While many of these prior works have implemented touch sensing and visual outputs, skin-worn technologies have integrated additional output modalities and sensing techniques. Tacttoo [215] is a skin-worn tactile display in the form of a temporary tattoo. Thin and conformal, Tacttoo enables wearers to *feel-through* the interface, preserving inherent qualities of touch. ElectroDermis [119] presented a fabrication approach for integrating electronic components into small, flexible, and stretchable skin-worn technology resembling electronic bandages. These DIY methodologies and HCI approaches have been enabled and inspired by Materials Science research on epidermal electronics [60, 93].

¹³Image credits. (a) & (b) Images from: Vega et al. 2015. Hairware: The Conscious Use of Unconscious Auto-contact Behaviors. IUI '15 [191]. (c) Image from: Kao et al. 2015. NailO: Fingernails as an Input Surface. CHI '15 [88]. (d) Image from: Kao et al. 2017. EarthTones: Chemical Sensing Powders to Detect and Display Environmental Hazards through Color Variation. CHI EA '17 [86].

Cosmetic Form Factors

While wearable technology has been expanding to a range of body sites and available form factors, new wearables have emerged that take inspiration from existing cosmetic practices. Of particular note are related topics of Beauty Technology [193] and Hybrid Body Craft [83] (See Figure 3.5). Beauty Technology [193] merges technology with beauty products including hair extensions [191], artificial fingernails [192], and makeup [190, 194]. Hybrid Body Craft [83] leverages culturally established practices, such as makeup [86], temporary tattoos [85], and artificial fingernails [88] as sites for technology. Hybrid Body Craft has an explicit focus on embedding technology in aesthetic body adornments to expand self expression capabilities.

Beauty Technology, Hybrid Body Craft, and *Heirloom Wearables* share a similar vision: to leverage existing form factors and body practices in the design and creation of new wearable technologies. My focus on *Heirloom Wearables* differs in my pivot away from engaging directly with “beauty” and aesthetics as a theme. While aesthetic considerations are relevant to the design of *Heirloom Wearables*, the focus is much broader, including interaction modalities, usage patterns, and other non-aesthetic characteristics.

3.3 Summary

Since the origin of Wearable Computing, device miniaturization and new materials have enabled a broad range of wearable technologies. These technologies have taken many forms, including those of traditional body-worn artifacts such as clothing, accessories, jewelry, skin-worn artifacts, and cosmetics. Wearable technologies that adopt existing body-worn artifacts have a unique opportunity to leverage existing practices and notions of those artifacts. However, they can be hard to design and there’s no defined methodology for this category of technology.

The *Design Framework for Heirloom Wearables* presented in this dissertation defines a methodology for using the body and its practices as inspiration to craft meaningful interactions and relationships with technology on the body. Furthermore, the design and development of exemplar *Heirloom Wearables* contributes to the design space of wearable technologies, demonstrating new forms, interactions, and experiences. Chapter 4 presents embodied wearable technology in the form of artificial fingernails. Chapter 5 explores hair as a design material through the creation of hair-worn technology. Chapter 6 details the design and implementation of dynamic clothing and accessories. Chapter 7 discusses the design space of interactive hats. Finally, Chapter 8 introduces a new interaction paradigm for skin-based electronics: Lotion Interfaces. These *Heirloom Wearables* operationalize the presented framework and demonstrate how it can be used to expand the existing landscape of wearable technologies.

Chapter 4

Fingernail Devices

To demonstrate how the framework can surface unexpected opportunities for technology on the body, I will first present designs that leverage form factors not conventionally adopted in commercial markets. The first of these unconventional designs is interactive fingernail-worn devices. One key distinction across the broad landscape of body-worn artifacts is that some artifacts are more easily and often removed than others. In this chapter, I focus on a specific class of wearables that are worn for weeks at a time without removal — artificial fingernails. Artificial fingernails occupy a unique location in the design space of on-body artifacts as a rigid substrate that is infrequently removed. This location in the design space is especially unique when considering the distribution of existing wearable technologies [11], which highlights a prevalence of watch, jewelry, clothing, and accessory form factors (shown in dark blue in Figure 4.1).

In this chapter, I highlight unique affordances of fingernail-worn artifacts, as well as technical limitations that inform the constraint-driven design of *Heirloom* fingernail technology¹. Viewing technical limitations as opportunities for design, I present the iterative implementation of three fingernail-worn devices that leverage the existing body practice of artificial fingernails. Finally, this chapter concludes with results from a design space exploration to probe perceptions of fingernail technology.

4.1 Introduction

The fingernail provides a unique substrate for combining interactive electronics with cosmetic forms. As a rigid, static surface, fingernails afford easy attachment of planar electronics and avoid durability and wiring complications that often arise from flexible connections that attach to more dynamic and malleable substrates such as human skin or clothing (*physicality*).

¹Elements of this chapter were previously published in: Christine Dierk, Tomás Vega Gálvez, and Eric Paulos. 2017. AlterNail: Ambient, Batteryless, Stateful, Dynamic Displays at your Fingertips. In Proceedings of the 2017 CHI Conference on Human Factors in Computing Systems (CHI '17). Association for Computing Machinery, New York, NY, USA, 6754–6759. DOI:<https://doi.org/10.1145/3025453.3025924>

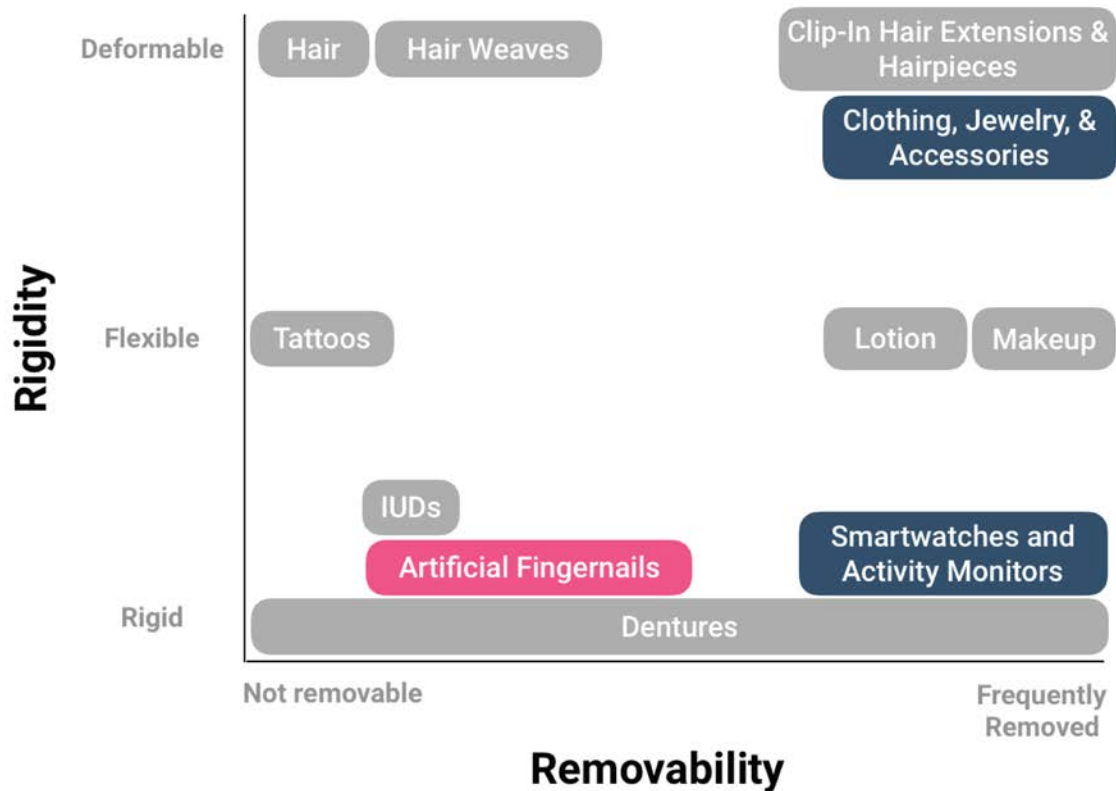

Figure 4.1: Rigidity and Removability of various body-worn artifacts. Artificial Fingernails (shown in pink) occupy a unique location in the design space as a rigid artifact that is infrequently removed. Most prevalent wearable form factors are shown in dark blue. Although, lotion and makeup alone are very deformable, we are specifically considering the properties of the form factors once applied to the body. Thus, lotion, makeup, and tattoos all assume the rigidity of skin: flexible but not deformable.

Fingernails are also highly visible and provide a readily glanceable display atop the fingertip (*aesthetics*). When we touch, handle, and interact with surfaces, objects, and people, our hands and fingers and hence our fingernails are intertwined within the interaction, making fingernails a compelling site for designing new technologies (*usage patterns*). In fact, using the fingernail as a substrate, wearable technologies can enable new interactions previously unattainable due to size constraints and the location of current wearable devices. Prior work has shown that fingernail-based sensing can enable new interactions that are private and discreet [26, 88], one-handed [88, 224], eyes-free [88, 224, 71], subtle [204], and quick [220] (*interaction modalities*). Finally, fingernail-based technology takes advantage of the broad cultural acceptance of attaching and wearing artificial fingernails (*social & cultural considerations*). The fingernail-worn devices presented in this chapter merge existing fingernail



Figure 4.2: Three generations of fingernail devices. All devices are powered wirelessly and feature an e-ink display. From Left to Right: AlterNail, AlterWear, TransformatioNail.

fashion and culture with new fabrication techniques as exemplars of *Cosmetic Computing*.

4.2 Related Work

Fingernail Devices

Companies and research groups have begun to explore the mass potential for finger and fingernail mounted technology [204]. This work includes subtle and readily available input devices [88, 26, 51, 124], passive technology such as NFC and RFID [179, 193, 192], and larger fingernail displays [175, 214]. There has also been research into fingernail interactions that are chemical, rather than electronic [94, 137]. While these projects have explored the potential for fingernail-worn technology, they all possess either a static display (limiting *aesthetics & expressive output*) or wired connections for power and communication (limiting natural movement and thus wearability [54]).

Prior work explored fingernail sensing using strain gauges [55, 72] and optics [121, 120, 77,

220] to sense force on objects and different surfaces, as well as hall sensors [26] and capacitive sensors [88] for touch input on the surface of the finger. Prior work has also explored visual displays [175, 204] and vibratory output [71] in fingernail form factors. Additionally, prior work has shown that fingernail sensing can be used as input to other devices [204, 27, 210, 175, 224, 76].

Many of these presented systems require charging or an external power supply (*power source*). Others lack internal computation and must be tethered to external devices such as phones, smartwatches, or laptops. Additionally, most of the form factors presented are large and non-aesthetic (*aesthetics*). These limitations restrict potential interactions and usage in the real-world.

Parasitic Power

This work also builds on prior work in parasitic power; that is, devices that are powered externally. Researchers have harvested power from human movement [102], public landscapes [143], personal objects [147], and radio waves [141]. In addition to power harvesting, wireless power is becoming more universal as smartwatches and other wearable devices become increasingly popular. The fingernail-worn devices described in this chapter are novel in that they don't store wireless or parasitic power; rather, they operate opportunistically. The devices are low-power (typically 1 milliwatt) and generally only require 250 milliseconds of power to power up, read and sample sensors, perform basic computations, and send new outputs to the e-ink display. After this time period, power is no longer necessary.

4.3 Constraint Driven Design

Fingernails are at the heart of countless interactions. Designing technology at this crux can enable a new realm of embodied interaction. Fingernails also enable ever-present, yet subtle displays (*aesthetics*). While the fingernail presents unique opportunities for interaction, it comes with its own set of challenges. The most prominent consideration is physical size (*physicality*). Since the fingertips are the foundation of interaction, bulky devices situated here would impede not only potential applications, but everyday activities. The largest component in existing fingernail-mounted devices is the battery. In addition to size constraints, including a battery poses other unique challenges for a fingernail-mounted device, such as how and when to charge. My view is that it is neither feasible nor desirable for a user to frequently remove and charge their fingernail devices.

Taking account of these constraints, the fingernail-worn devices presented in this chapter were designed without a battery or other internal power supply (*power source*). The devices uses resonant inductive coupling to power wirelessly. With this design comes new constraints. The wireless power receiver supplies up to 5V intermittently — well beyond the 1.8v operational levels required by the hardware. The devices are only powered when in close proximity to a transmitter. This introduces a hardware constraint, as well as an

interaction constraint (*interaction modalities*). First, all components must operate at a low voltage and be able to function with intermittent power. It also means that interactions with the device are best focused around contact with objects — specifically those capable of powering, communicating, and updating the fingernail devices wirelessly.

E-ink displays nicely address this new set of constraints (*expressive output*). This type of display is ideal for fingernail devices for 5 main reasons: (1) e-ink displays can be manufactured at a small scale (6x6 mm, *physicality*), (2) e-ink displays operate at low voltage (5V, *power source*), (3) they can be designed in a wide variety of custom configurations (*customizability*), (4) they are low-cost, and perhaps most importantly (5) e-ink is bistable, which means it doesn't need power to hold an image. The fingernail-worn devices presented in this chapter leverage this property of e-ink displays —they only need power for a few milliseconds to change state and do not require any power to maintain state [32, 33].

These constraints and considerations informed the design and fabrication of several fingernail-worn devices: AlterNail, AlterWear, and TransformatioNail (See Figure 4.2). These fingernail-worn devices are ambient, the display is always available, yet changes slowly and in a subtle way; batteryless, the device is powered wirelessly; stateful, the e-ink display (as well as the non-volatile microcontroller storage) maintains state even after power is removed; and dynamic, the display changes throughout the day based on interactions with various everyday objects.

4.4 AlterNail

The first iteration of fingernail-worn devices resulted in AlterNails: small interactive electronics that attach to fingernails with commonly available acrylic nail glue (See Figure 4.3). A central focus of the design was to avoid developing yet another wearable device to care for, charge, and nurture. The result is a compelling example of how to develop personal wearable devices that embed interaction, information, and fashion while avoiding the need to replace or charge batteries. Each AlterNail has a small e-ink display that is always available and easily glanceable. This display is powered and updated when a user interacts with an AlterNail-enabled smart object. Such objects are embedded with a wireless power transmitter and a vibratory motor. As objects are touched and handled, the AlterNail is powered wirelessly via inductive coupling. The AlterNail performs simple sensing and computation based on the application, updating the e-ink display as appropriate. I argue that the power and interaction limitations provide a constrained but rich new design space appropriate for a range of small, functional, fashionable new wearable devices and applications.

Implementation

The heart of AlterNail is a custom-built printed circuit board (PCB). The PCB contains an ATTiny85 microcontroller, an analog accelerometer, a wireless power receiver with attached coil, and an e-ink segmented display (Figure 4.4). When a user interacts with an AlterNail



Figure 4.3: AlterNail being worn and closeup of an AlterNail design.

enabled smart object, power is transferred from the object to the AlterNail. These AlterNail enabled smart objects are each programmed with a unique vibration pattern. Upon start-up, the AlterNail uses the accelerometer to detect these vibration patterns and determine which object the user is interacting with. Identification information can also be sent wirelessly over the inductive coupling link such as NFC without using vibration. Once the object has been recognized, the e-ink display updates. This display is maintained even after the user has stopped interacting with the object. The functional AlterNail prototype used a series of individually addressable dots capable of being reconfigured by the microcontroller (Figure 4.4). This e-ink display has a refresh rate of 250 milliseconds. AlterNail's implementation uses the Wireless Power Reference Solution from IDT for both transmitter and receiver. At peak power, the entire system consumes about 1 milliwatt from the microcontroller at $300 \mu\text{A}$ and the e-ink at $1 \mu\text{A}$ when switching.

AlterNails are easy to apply and remove; they use commonly available acrylic nail glue to attach to the fingernail. Additionally, AlterNail includes custom vinyl sticker overlays that conceal the electronics and allow for user personalization. AlterNails are low-cost at less than \$4 USD bill of materials per AlterNail. This allows users to easily reapply, replace, or reprogram them every few weeks. AlterNails are approximately 16 mm by 26 mm and 4.6 mm thick. Thickness can be further minimized by utilizing a thinner PCB.

AlterNails require interaction with specially designed AlterNail enabled smart objects in order to function. These objects contain a wireless power transmitter, a microcontroller, and optionally a vibration motor. The enclosed components are small and can easily be added

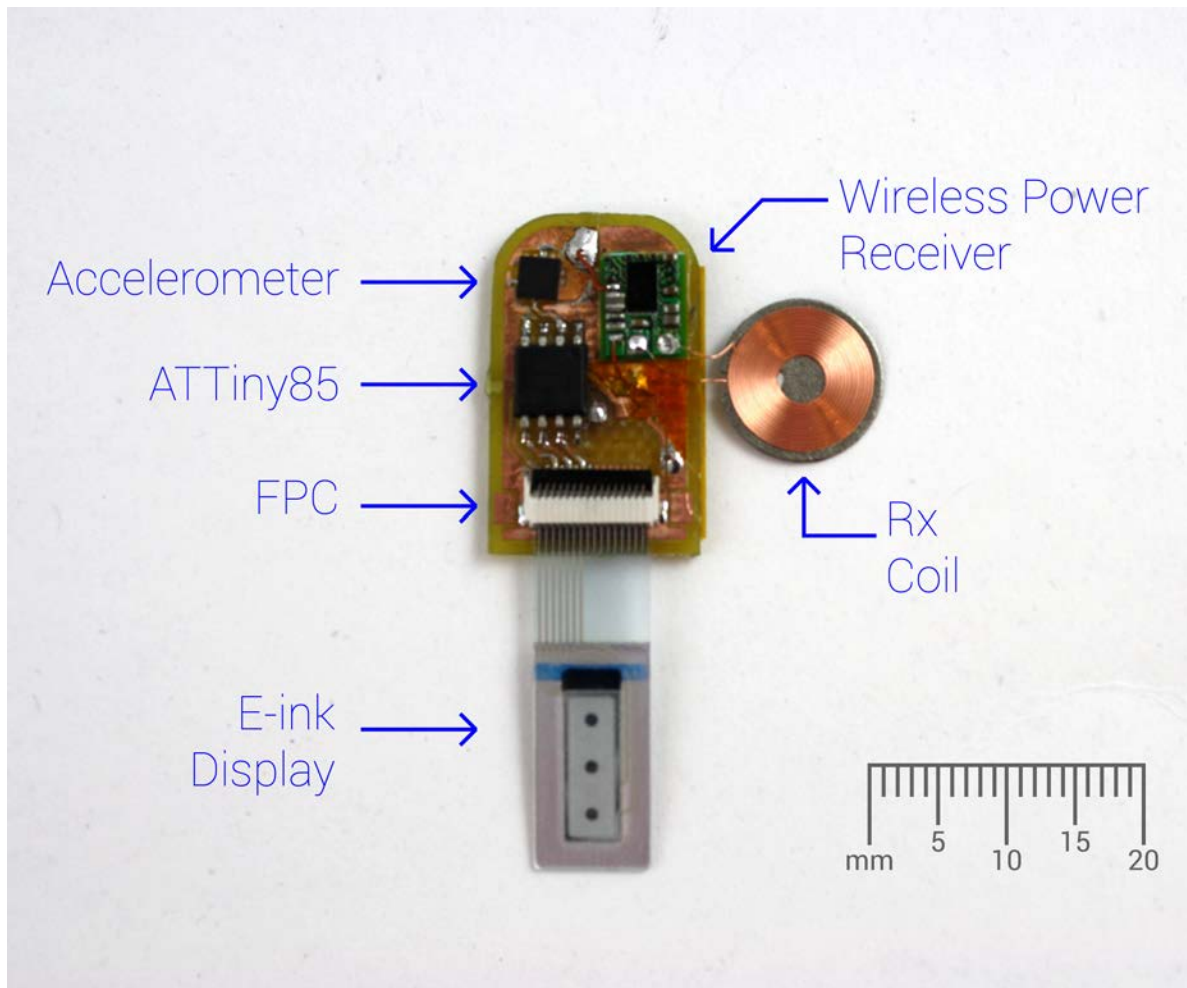

Figure 4.4: Custom designed AlterNail with accelerometer, ATTiny85, a wireless power receiver, inductive coil, and e-ink display.



Figure 4.5: Left: Credits and Usage scenario demonstrated with an AlterNail enabled cookie jar. When the user opens the cookie jar, a new dot is added to their AlterNail display. Middle: Object Status scenario demonstrated with an AlterNail enabled chisel. As displayed by the AlterNail, this tool has been used three times today. Right: AlterNail updated through NFC from a smartphone. The user can discreetly check that they have one new email without unlocking and looking at their phone.

to a number of everyday objects and artifacts as demonstrated in Figure 4.5.

Envisioned Applications

While the AlterNail design includes several constraints, it also lends itself to a variety of interactions that fuse fashion and function. I highlight a selection of four interaction categories: (1) pick a design, (2) credits and usage, (3) object status, and (4) free form designs (Figure 4.5).

Pick a Design

AlterNails can be used for displaying designs as objects are touched. For this family of interactions, each AlterNail enabled smart object is associated with a particular e-ink configuration; when the user interacts with an object, its “visual” is displayed on the AlterNail. With regards to the current prototype, this means having objects that trigger specific dot configurations; however, one can imagine rich interactions with more intricate e-ink designs. Tapping a “Learn Korean” flier could display the phone number for later use. Daily activities, such as playing basketball or knitting, could showcase icons as a quasi-diary. Specific locations could reveal unique designs, reminiscent of Snapchat’s geofilters², Pokémon Go³, and other geocaching applications. For example, touching the turnstile at a baseball stadium could showcase the home team’s logo.

²<https://www.snapchat.com/>

³<https://www.pokemongo.com/>

Credits and Usage

AlterNails can also be used to track credits and usage. The simplest of these interactions is an activity counter. The AlterNail displays a new dot each time the user interacts with a specified object. This is useful for tracking water consumption, snacking, and other habits. The AlterNail can also measure length of interaction: adding a new dot for every x minutes spent interacting with an object. This is useful for measuring practice of an instrument, timing bike rides, and keeping track of other daily activities. Another variation of this interaction includes AlterNail enabled smart objects that add dots, as well as objects that take them away. An example is an AlterNail that tracks hand washing. Unsanitary surfaces such as trash bins and toilets add dots to the AlterNail, whereas hygienic fixtures such as sinks and showers remove all dots from the AlterNail.

Object Status

AlterNails can also be used for checking the status of objects. Touching a bus stop could display when the next bus is arriving. Grasping a flashlight could show battery levels. Tapping a conference table could reveal whether or not the table has been reserved. Gripping a handsaw could display the amount of wear on the blade. Touching a malfunctioning washing machine could reveal failure details.

Free Form Designs

AlterNails can be designed to be NFC-driven and powered by mobile devices. In this case, AlterNails could be used for notifications, such as an incoming text or an alarm. While similar to Ringly⁴ and other wearables, AlterNails are unique in their physical location, as well as their ambient nature: rather than vibrating or lighting up with notifications, AlterNails change slowly and in subtle ways.

AlterNails can also enable interactions in which smartphones provide additional information. Rather than gathering all information from objects, AlterNails can discern location, time, and other factors directly from the user's smartphone. Borrowing from one of the previous examples, simply being at a baseball stadium and interacting with a smartphone could cause the team's logo to appear across the AlterNail, rather than requiring the user to be in contact with a particular AlterNail enabled turnstile. The smartphone would detect the user's location, determine the appropriate e-ink configuration, and power/communicate with the AlterNails via NFC.

4.5 AlterWear Fingernail Form Factor

Extending AlterNail, AlterWear included the design and fabrication of a second fingernail device (See Chapter 6 for an overview of AlterWear). Key differences include leveraging NFC

⁴<https://ringly.com/>

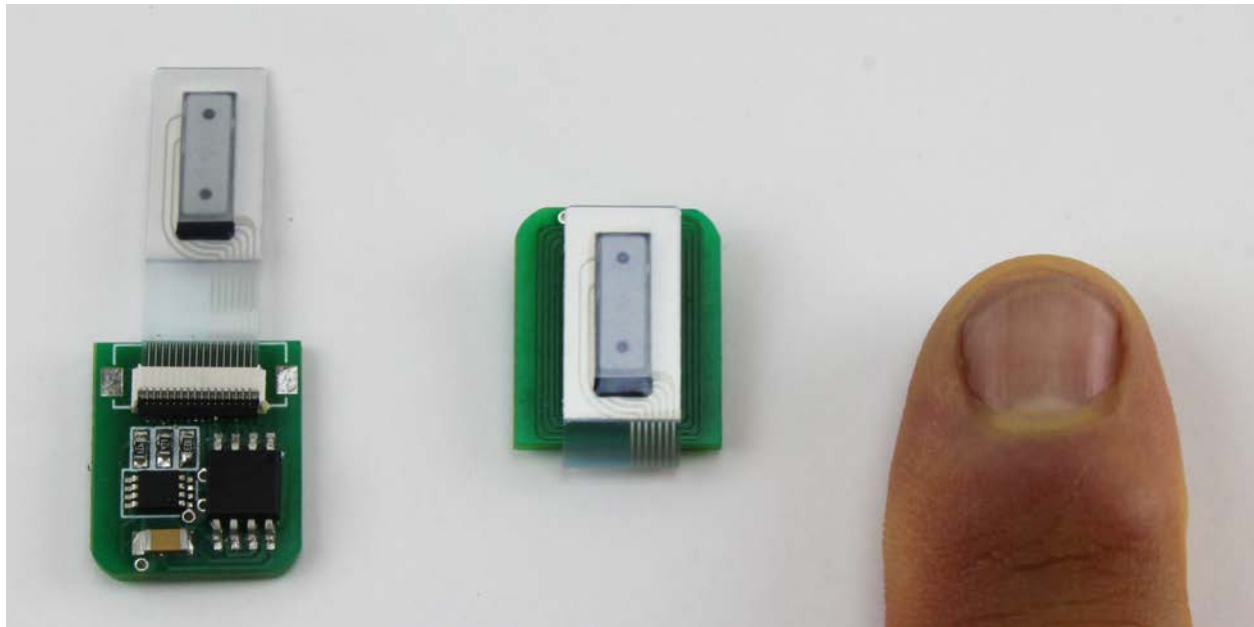

Figure 4.6: The fingernail AlterWear design with custom circuitry and e-ink (Left) and folded over into a more compact fingernail form factor exposing the dynamically programmable e-ink dot pattern (Middle) next to an actual fingernail (Right).

instead of wireless power, removal of the accelerometer, and miniaturization (See Figure 4.2 for a visual comparison).

By leveraging NFC over wireless communication protocols, the AlterWear fingernail device combines communication and power in a single channel, eliminating the need for specially designed smart objects with distinct vibration patterns. Expanding interaction capabilities, the AlterWear fingernail device is capable of interacting with any NFC-enabled device. No longer necessary to distinguish external objects, the accelerometer was removed from the device and the design was miniaturized. The entire PCB measures 18.2mm long, 15.3mm wide and 3.55mm thick.

A consequence of shifting from wireless power to NFC is lower voltage. In contrast with 5V provided by wireless power, NFC provides 2.9V. While still sufficient to power the fingernail worn device, the visual clarity of the e-ink display is diminished (See Figure 4.2 for a visual comparison).

4.6 TransformatioNail

TransformatioNail, the third iteration of fingernail-worn devices, aims to augment the wearer with new forms of minimalist and personalized tangible interaction. TransformatioNail is

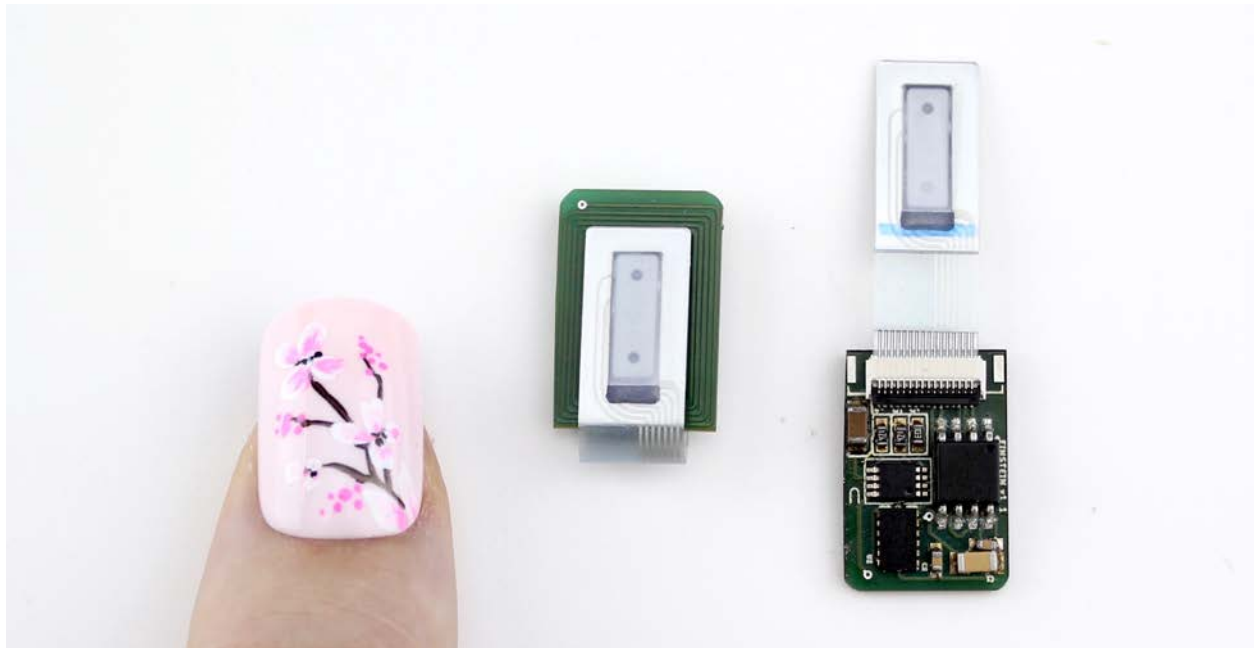

Figure 4.7: TransformationNail is a small fingernail worn device that attaches to the nail with acrylic nail glue. The core component is a custom designed PCB (right) that includes an e-ink display, among other components. The e-ink display folds over to make the nail more compact (middle). The size of the nail is comparable to a generic acrylic nail (left).

a smart device capable of gesture sensing and wireless data transfer, as well as displaying information. Similar to the previous iterations, TransformationNails attach to the nail with acrylic nail glue and can be worn for weeks at a time without removal (*removability*). TransformationNail is a novel fingernail worn device capable of gesture sensing, dynamic memory storage, and wireless communication with external devices. I present implemented scenarios and applications to explore new interactions afforded through the device. Finally, I present results from a design space exploration with potential users that leveraged the functional prototype as a catalyst with which to probe perceptions of fingernail technology. From this study, I present considerations for the design of future fingernail-worn technologies.

TransformationNail expands the previous iterations of fingernail-worn devices by incorporating on-board gesture sensing and custom memory organization. While AlterNail included an accelerometer, it was used to distinguish between AlterNail enabled smart objects and was not utilized for gesture sensing. The AlterWear fingernail did not include an accelerometer. Neither AlterNail nor the AlterWear Fingernail utilized dynamic memory storage. With these features, TransformationNail affords new interactions that are infeasible using the prior implementations.

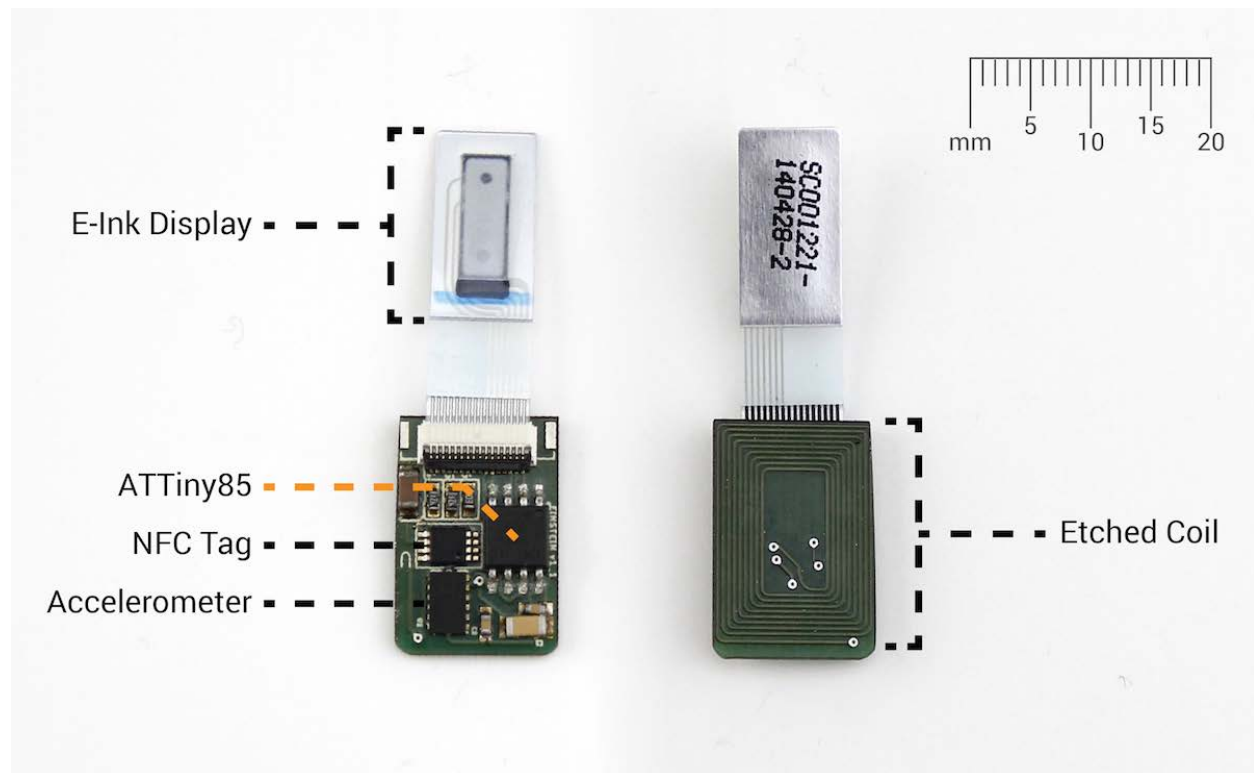

Figure 4.8: Custom designed PCB containing an e-ink display, ATTiny85 microcontroller, NT3H1101 NFC tag, and an ADXL345 accelerometer. A coil is etched into the backside of the board for both data and power transfer. The size of the PCB is 13.45mm x 19.85mm and 3.55mm thick.

Nail Design and Hardware Architecture

To avoid complex wiring or asking wearers to remove and “charge their fingernails”, TransformationNail is powered wirelessly through interactions with objects and devices. This design decision, paired with the small form factor, imposed strict requirements of size, power, and wide operating voltage on all other components. Additionally, the desire to support a wide range of interactions mandates interoperability with a number of different devices. The microcontroller, sensor, display, and communication protocol were chosen to meet these specifications.

TransformationNail includes an ATTiny85 microcontroller, an ADXL345 accelerometer, an e-ink display, and an NT3H1101 NFC tag (see Figure 4.8). A coil is etched into the backside of the board. The device has the dimensions 19.85mm x 13.45mm x 3.55mm, which were sufficient for evaluating new interactions. At peak power, the entire system consumes about 1 milliwatt from the microcontroller at 300 μA , the accelerometer at 40 μA when taking a measurement, and the e-ink at 1.5 μA when switching [48].

Memory

Standard NFC tags are capable of storing only one distinct NDEF message; TransformationNail implements careful memory organization of the nTag IC to enable multiple distinct entries. This allows TransformationNails to keep a history of tangible interactions, and to be used in multiple contexts without the need for reprogramming. The NT3H1101 NFC tag allocates 222 pages for memory. In TransformationNail, 220 of these pages are utilized for user data, allocating fixed data blocks of 10 pages (i.e., 40 bytes) for storing each unique entry. Thus, each TransformationNail supports storing up to 22 unique data entries. TransformationNail utilizes one page for communicating notifications from the mobile, and the last page for storing custom metadata. This structure assumes that each data record is less than 40 bytes; if the data exceeds the size of TransformationNail's predefined data block, the data is stored in a web server and the link is written to the TransformationNail. Retrieval of the data is conducted by the client program in the respective context. However, this scheme can be easily modified to include flexible numbers of data bytes per record.

Sensing

Prior work has shown that accelerometers are capable of characterizing complex gestures including finger orientation, shear, and others [46, 145, 113, 199, 219]. This prior work demonstrates characterization of more complex gestures; as proof of concept, TransformationNail implements touch and tap detection. Using a thresholding algorithm across the different axis signals, TransformationNails are able to distinguish simple touch gestures from tapping gestures. In addition, TransformationNails are capable of detecting multiple taps in quick succession as a separate gesture. While limited, this gesture set is sufficient for probing perceptions of fingernail technology.

False positives are often a problem in fingernail sensing systems [55]; however, TransformationNail is not liable to false positives. Since the device is only powered when in close proximity (4 cm) to a powered NFC-enabled device, everyday interactions with unrelated objects will not power the device or trigger false positives.

Display

The e-ink display is utilized to provide visual feedback to the wearer, particularly with regards to whether or not a gesture has been recognized. E-ink is well suited for TransformationNails in terms of size, power, operating voltage, and intermittent power. E-ink displays can be made very small, flexible, and in a wide variety of shapes and designs. Furthermore, e-ink is low-power and bistable, which means that it is able to retain state without continuous power.

Auxiliary Electronics

TransformatioNail’s implementation requires specialized objects and devices to interact with. Objects must have a power supply and NFC. Devices such as laptops, Smartphones, and IoT devices must run specialized software capable of parsing the data on the nail; however, this software is trivial and easily uploaded. In the implementation of proposed applications, laptops and everyday objects were augmented with an Arduino Uno microcontroller and a PN532 RFID/NFC shield. The implementations of Copy/Paste and Notifications applications utilized an NFC-enabled Android phone with a custom application for communicating with the TransformatioNail.

Technical Considerations

- **Distance from coil:** With the current implementation, the coil on the TransformatioNail must be closely aligned with corresponding coil on the Smartphone, laptop, augmented object, or IoT device. This could be improved by expanding the range of the transmitting coil, refining the on-board coil, or using RFID.
- **Latency:** While the NFC communication is quick (A 4-byte write operation over NFC occurs in 4.8 ms to EEPROM and 0.8 ms to SRAM), the time to power up and refresh the e-ink display takes between 2 and 4 seconds to completely update. Additionally, the current software implementation takes a few seconds to fully read the TransformatioNail and parse the data. Experiences with participants in the conducted user study suggest that the latency of the e-ink display worked to convey the less visible latency of the system. Specifically, the latency of display cued users to hold the nail in position longer, as all of the data was transferred across.
- **Contrast of E-ink Display:** As there is no source of on-board power, TransformatioNails are constrained to operating at 2.9V, the amount that can be harvested over NFC using the coil and other hardware. E-ink displays recommend a power supply of 5V or 15V [48]. While this voltage is sufficient to power and update the E-ink display, the contrast on the display is diminished and it can be challenging to discern updates to the display (See Figure 4.7). This can be improved with voltage boosters or super capacitors; however, this doesn’t affect functionality or the evaluation of such a device, so these components have been excluded at this stage.
- **Size and Durability:** It was not a primary goal to significantly reduce the size of TransformatioNail; however, almost all of the components on the prototype can be manufactured at smaller scale. The PCB itself can be made flexible, curved, and significantly thinner. If miniaturized, fingernail devices could be worn for days or even weeks at a time without removal, as an acrylic nail. Additionally, prior work has shown that electronics can be enclosed in gel nail polish [192]. Using similar techniques, the fingernail devices can be made durable and robust and could feasibly be worn for this period of time.

Nail Interaction

A typical interaction with begins when TransformatioNail comes in close contact ($< 4\text{cm}$) with an NFC-enabled device.

Skye is in a meeting, but wants to know if she has any missed calls. She taps once on the NFC coil of her smartphone to check, briefly holding her finger in place over the coil as the e-ink display updates.

The TransformatioNail comes into range of NFC (powering all of its components) before the physical tap on the surface of the phone. The accelerometer detects the tapping gesture and sends an interrupt to the microcontroller, which sets the gestureID in the memory of the NFC tag. The microcontroller begins to monitor the memory of the NFC tag—awaiting an update from the mobile.

The smartphone detects Skye’s TransformatioNail and a custom mobile app uses the nail’s ID and the gestureID to discern that missed calls are requested. The smartphone retrieves this information and writes it into the memory of the NFC Tag.

Still monitoring the memory of the NFC tag, the microcontroller reads the number of missed calls from the memory of the NFC tag: 2. The microcontroller then updates the e-ink display with this information: 2 dots appear on the display.

Skye removes her TransformatioNail from her phone.

Leaving the range of NFC, the TransformatioNail is no longer powered, and no longer capable of communicating with the smartphone. However, the e-ink display remains updated with 2 dots, even after power is removed.

Skye glances at her nail and sees that she has 2 missed calls. She excuses herself from the meeting, concerned that it might be something urgent.

This entire interaction from start to finish can be as brief as 2-4 seconds and performed through fabrics and other thin materials, including clothing, backpacks, and bags. In addition, the interaction is discreet, requires no direct access to the Smartphone (with the exception of close proximity), and can be done without averting the wearer’s gaze or attention from the current task.

Applications

Since TransformatioNail utilizes the NFC protocol, it is innately capable of applications proposed in prior work [192]. In addition, the on-board accelerometer and microcontroller allow for more compelling interactions. Driven by the hardware design, I present four exemplar applications for TransformatioNails. These applications were chosen to showcase a range of interactions enabled through TransformatioNails.



Figure 4.9: TransformatioNails can augment interactions with existing technology.

Bookmarks

While TransformatioNails can be used to keep track of digital data, they can also enable physical objects to be similarly “bookmark-able”. Brushing against a movie poster could store the affiliated website on the nail; fiddling with a tag on a sweater could store a link to purchase it online (Figure 4.10); tapping a professor’s name plate could store their email address. Replaying the gesture used to encode a particular entry can display affiliated data when using a laptop, television, or other display. As discussed under Auxiliary Electronics, this application requires “bookmark-able” objects to be powered and NFC-enabled.

Copy/Paste

TransformatioNails can be used to copy and paste data between devices. For instance, a user can select text on a smartphone, tap their nail to the embedded NFC coil to copy, and then touch a laptop to paste the information. TransformatioNail’s implementation does not require a network and is therefore ideal for contexts and situations where network connectivity is nonexistent or sparse. These contexts include developing regions, in-flight interactions (Figure 4.11), and rural farming and trade. While TransformatioNail is not the first to envision copy and paste functionalities at the touch of a finger [129, 214], its implementation affords this interaction and is seemingly the first to store copied information on the finger itself.

Notifications

TransformatioNails can be used for discreet notifications. Rather than taking out a smartphone to check for notifications, a wearer can simply place their nail over the NFC coil of their device, perform a gesture, and then discreetly glance to see if the nail display has changed. This interaction can even occur through clothing – for instance stroking the outside



Figure 4.10: Bookmarks. Lina can’t decide whether or not to purchase the beautiful yellow scarf she finds in an airport boutique while awaiting her departure. Feeling under pressure, she double taps the NFC-enabled price tag to “bookmark” the scarf and heads to her gate empty handed. The following evening, back in her apartment, she performs the same gesture on her NFC-enabled laptop, which brings up the item in the boutique’s online shop. She peruses the 30 reviews, eventually deciding to purchase the scarf.

of a pants pocket containing a smartphone (See Figure 4.12, left). Data is transferred easily through the less than 4 cm of fabric and the TransformatioNail display updates to reflect current status. I envision wearers associating gestures to specific notifications: an downward flick over the NFC coil could retrieve Twitter notifications; drawing a heart over the NFC coil could query “missed calls from Mom”.

Settings

TransformatioNails can be used to store preferences and settings for external devices. This application is particularly useful with the ever-expanding Internet of Things. Rather than using a smartphone to specify preferences, simply touching the NFC-enabled device will upload user-specific preferences. Gestures can be used to distinguish between multiple sets of personal settings (e.g., different lighting preferences for reading vs watching television) and to provide tangible control of physical devices (See Figure 4.12, right). While preferences could be specified using fingerprint scanning or facial recognition, many IoT devices are already equipped with NFC. Rather than updating these devices with new and potentially expensive technology, a simple software update would render them compatible with TransformatioNails.



Figure 4.11: Copy/Paste. Katja and Henrik are preparing for their presentation en route to the conference. Unfortunately, their short flight does not include WiFi for purchase. When Katja sees that Henrik has written a succinct description of their technical implementation, she gestures on his NFC-enabled laptop to copy the text. She then performs the same gesture on her own NFC-enabled tablet, pasting the text into her copy of the slide deck.

4.7 Design Space Exploration

The functional TransformatioNail prototype served as a catalyst with which to probe perceptions of fingernail technology more generally.

Participants

I conducted a design space exploration of fingernail technology with 15 participants (age 18-29, avg. 22.7 yrs, 9 Female, 14 right-handed). Seven participants owned or had previously owned wearable devices including smartwatches and activity monitors. Only 1 participant had previously worn false or acrylic nails; 8 participants had previously painted their nails.

Procedure

Participants were recruited from local university mailing lists and invited to a studio location for an hour-long design space exploration. They were compensated at the rate of \$20/hour. Participants were shown the physical prototype, videos of all four proposed applications, and demonstrations of interactions with both laptops and mobile devices. Participants were

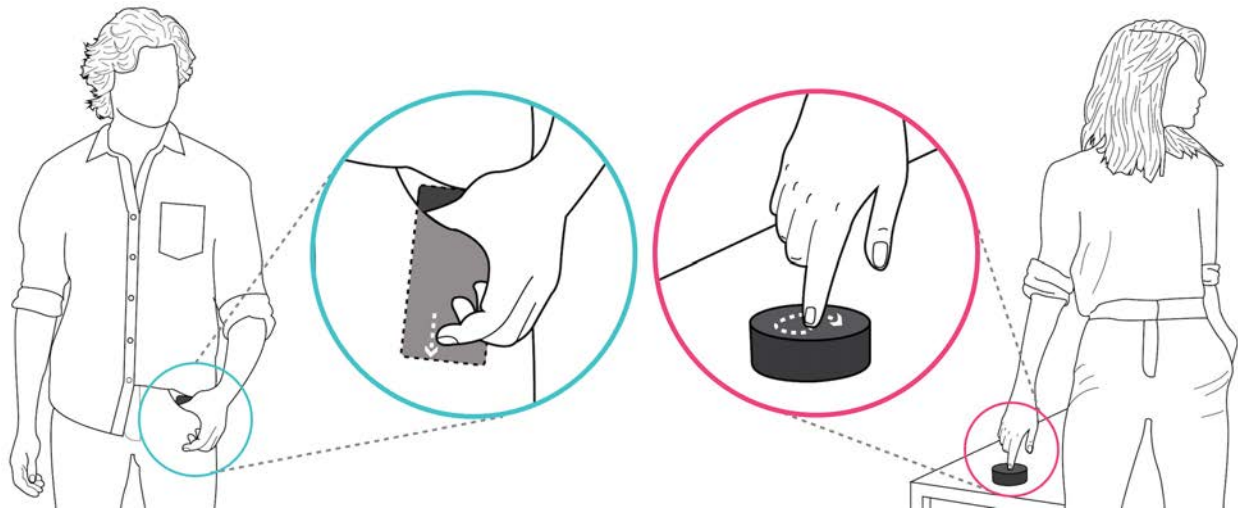

Figure 4.12: Left, in blue: Notifications. Pierre is anxious to know if his important package has been delivered; however, he has just run into the new headmaster at his son’s school, and doesn’t want to seem rude by taking out his phone. Instead, he places his hand on his hip, discreetly aligning his TransformatioNail with the phone in his pocket. He flicks his finger downwards, requesting Amazon delivery notifications. A wave of relief washes over him when he glances down and sees the updated display on his TransformatioNail. His package is safe at home. Right, in pink: Settings. When Antonia passes by her daughter’s room, she notices that Sofia has fallen asleep reading again. Not wanting to wake her with a voice command, Antonia performs a simple gesture on the smart speaker. The lights dim, a nightlight flickers on, and a faint whisper of waves can be heard emanating from the speaker. Antonia quietly leaves the room as Sofia continues to slumber.

encouraged to touch and interact with the functioning prototype. Finally, I conducted an informal interview to garner thoughts and reactions, and ended with a brainstorming activity.

Brainstorming Activity

The brainstorming activity consisted of two exercises: *Disparate Digits* and *Unconstrained Use*. For each exercise, participants were given a template of two hands, a Sharpie, and color-coded post-it page markers corresponding to each proposed application (Bookmarks, Copy/Paste, Notifications, and Settings). These applications were presented as a concrete starting point with which the participants could begin to imagine fingernail technology in their day-to-day activities. Participants were also provided an additional color to be used for custom applications outside of the presented four. Participants were encouraged, but not required to use custom applications.

For *Disparate Digits*, participants were instructed to assign each application to a separate



Figure 4.13: Top: Sample of results from *Disparate Digits*. Bottom: Sample of results from *Unconstrained Use*.

finger on a single hand (See Figure 4.13 for a sample of results). Participants were instructed to use either the left hand or the right hand of the template, but not both. Participants were intentionally limited to tease out perceptions of and differences between fingers. Rather than spreading applications across two hands, or clustering them on a single finger, participants were forced to consider each finger (and its affordances) individually.

For *Unconstrained Use*, participants were instructed to design what they personally would want and would use. This was described as a “free for all” in which participants could use as many or as few applications as they desired. Participants were allowed to use both hands of the template, have multiple fingers for a single functionality, and/or cluster multiple functionalities on a single finger. A sample of results from both exercises can be found in Figure 4.13.

Analysis

All interview meetings were audio recorded, transcribed, and analyzed, following best practices for a qualitative interview [208]. Across the 15 participants, I collected 15 surveys (including participant’s prior experience with wearable devices and rankings of proposed applications), 30 annotated templates, and almost 14 hours (13h:58m:18s) of audio recordings.

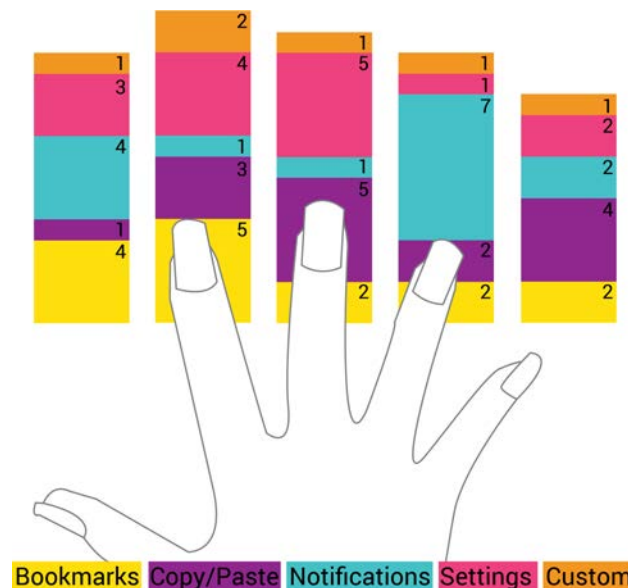

Figure 4.14: Participants that placed each function on a given finger in *Disparate Digits*.

This data was analyzed using grounded theory.

Findings

Participants' distribution of functions in each exercise can be seen in Figures 4.14 and 4.15. First, I describe perceived differences between fingers. Then, I focus findings on clear themes that emerged throughout the study. These themes fall into two categories: those regarding interaction, and those regarding wearability.

Perceived Differences Between Fingers

Participants perceived distinct differences between their fingers and associated affordances.

- **Index:** Participants universally viewed the index finger as the most natural, and considered it an ideal location for technology. During *Unconstrained Use*, all but 1 participant assigned functionalities to their index fingers. Additionally, participants assigned the most functionalities to index fingers: a combined total of 43 functions (53.1% of all functionalities placed). Participants universally felt that the index finger was the most natural for interacting with devices and real world objects alike.

I would find it almost weirder to have to touch things with different fingers when that wouldn't be my normal touch gesture (P3).

It feels more natural to use pointer fingers cause you're saying "this is important". You're pointing it out (P7).

- **Middle:** Participants had mixed feelings about their middle fingers. While some participants thought that this finger was maneuverable and somewhat “natural” for physical interaction (P2, P5, P7, P8, P12), others viewed it as a culturally inappropriate location for technology (P9).
- **Ring:** Many participants noted that the ring finger is hard to move independently and therefore not ideal for dexterous interactions. In *Disparate Digits*, 7 participants chose to use this finger for Notifications (compared with 6 participants who chose other functions, and 2 participants who excluded the finger entirely). This placement had the highest agreement of any in *Disparate Digits*. These participants thought that Notifications required minimal pointing and other dexterous movements, and was thus well suited to the ring finger. During *Unconstrained Use*, only 1 participant assigned functionalities to the dominant ring finger; 3 participants utilized the non-dominant ring finger.
- **Pinky:** Four participants excluded the pinky finger during *Disparate Digits*; only 3 participants put functionalities on either pinky during *Unconstrained Use*. Participants described this finger as tiny (P1), unnatural (P15), and “kind of weird” for interactions (P6). Whereas most participants thought the pinky was “too small” for technology, or would lead to unusual interactions, P11 envisioned using the pinky as a way to distinguish between automatic and conscious interactions. Alternatively, P1 thought the pinky was ideal for keeping technology “out of the way”.
- **Thumb:** Five participants identified the thumb as a good location for notifications and other visual displays, noting that the finger is larger and that the nail often remains in the user’s field of vision, even when writing or interacting with objects.

Designers of fingernail technologies should consider the trade-offs between different fingers. Key considerations are *relative dexterity*, *social appropriateness*, *size*, and *visibility*.

Themes Regarding Interaction

Desire for “Natural” and Embodied Interaction: Participants had strong inclinations towards interactions that felt natural and embodied. These inclinations were made apparent through participants’ prioritization of dominant hands and index fingers, as well as their comments throughout both exercises. Ten participants used their dominant hand for *Disparate Digits*. During *Unconstrained Use*, 5 participants confined all functionalities to their dominant hand (compared with 3 participants who used only their non-dominant, and 7 participants that utilized both hands).

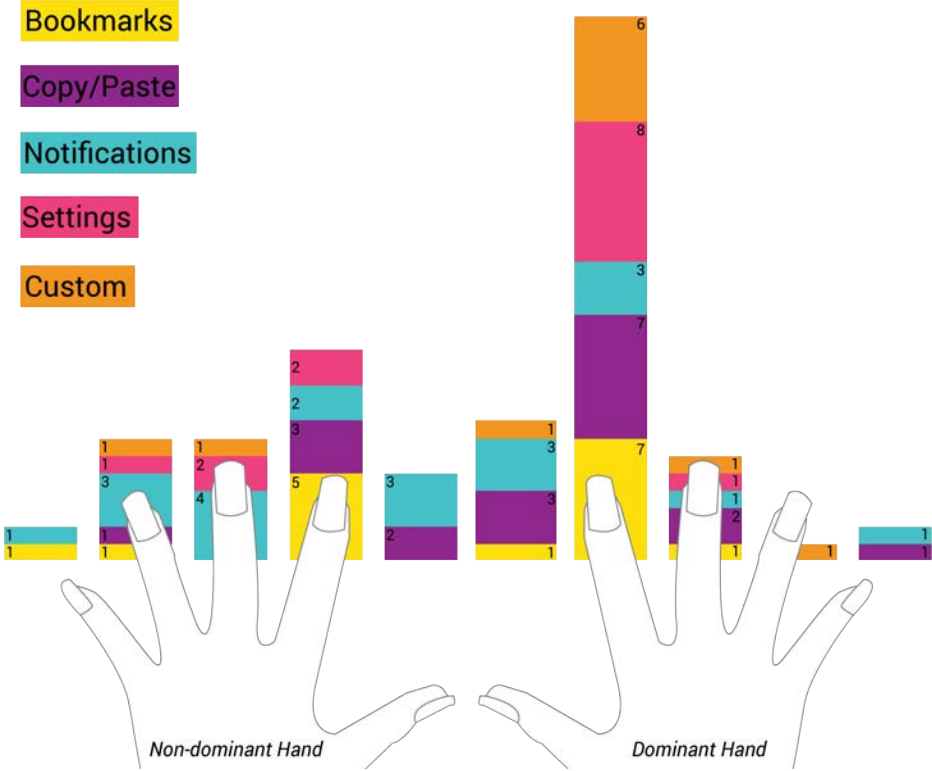

Figure 4.15: Participants that placed each function on a given finger in *Unconstrained Use*. This figure shows the dominant hand on the right because 14 of the 15 participants were right handed (the left handed participant’s data is included, but mirrored so that all dominant hands are on the right). Custom applications included user authentication, payments, the ability to unlock RFID doors, and controlling music.

I feel pretty much inept with my [non-dominant] hand. It doesn’t feel like a natural thing for me to ever go for something with my [non-dominant hand] (P2).

Having [fingernail devices on] my [dominant] hand feels more natural because that’s the tool-using hand, so I already know that those functions are there. Plus I don’t feel as confident with my [non-dominant] hand, so it just doesn’t feel as natural to me (P12).

Alternatively, the participants that confined functionalities to their non-dominant hand were concerned about fingernail devices getting in the way of day-to-day activities (P1, P15), being uncomfortable (P14), or wanted to enable multi-tasking (P4, P8).

During the brainstorming activities and throughout the user study as a whole, all 15 participants began tapping their fingers on the table, chair, or their own lap. Several participants even began touching things throughout the room, verbalizing imagined applications

and brainstorming through physical touch. This universal physical exploration of space hints that the imagined applications were truly embodied; participants found it difficult to contextualize the interactions without physically performing them. In addition, several participants viewed the fingernail device as “extension of self”, rather than a discrete wearable device.

I wouldn't have to worry about [my fingernail device] everyday: having to charge it, or having to remember to put it on. Especially for me, with my [prosthetic] leg, it's like all these pieces kind of have to come together everyday, so one less thing to worry about would be nice (P6).

Technology located at the fingertip provides unique opportunities for embodiment. Designers of fingernail technology can amplify these merits by leveraging dominant hands and index fingers. However, as mentioned previously, the other, non-index fingers have merits of their own and can prove beneficial for particular types of interactions.

Distinction Between Conscious & Automatic Interactions: While participants appreciated “natural” (P6, P7, P12, P13, P15), “direct” (P4, P9), and “automatic” (P7) interactions afforded by fingernail devices, several participants made a distinction between interactions that they wanted to be automatic, versus ones that they wanted to be conscious. Participants also envisioned ways to situate their nails to facilitate these interactions.

*I wanna be sure if I'm changing the settings, like I'm actually making conscious decisions. Maybe the pinky? Like I have to touch it like that *taps pinky on the table*. It's very intentional (P11).*

P9 was concerned about accidentally collecting unintentional Bookmarks throughout her day; however, she viewed this as a small price to pay for being able to quickly and conveniently Bookmark things intentionally.

Technology located at the fingertip provides a unique opportunity for automatic interactions. Wearers have the capability to interact with technology without straying from their normal gestures and interactions with objects. However, this convenience must be tempered by consideration for accidental triggers and unwanted actions. Designers of fingernail technology must balance the trade-offs between convenience and robustness. One way this can be achieved is by utilizing unique gestures or less natural fingers (as did P11) for actions of greater consequence (such as changing the settings of a thermostat or texting an ex).

Themes Regarding Wearability

Delicate Balance of Fashion and Function: When considering whether or not they would feel comfortable wearing fingernail devices in their day-to-day activities, participants hinted at a delicate balance between fashion and function. Some participants were interested in fingernail devices as a fashion statement or conversation starter.

As long as it's not uncomfortable, I would wear [the fingernail device] just for aesthetic reasons (P9).

People would notice [if I were wearing the fingernail device], not that I would really mind. They would ask questions and [I would] get to talk about [the device]. It's pretty novel. No one is going to ask about a watch (P12).

Alternatively, other participants gravitated towards functionality, and were uninterested in the aesthetic qualities (P6, P10). In fact, my experience with participants suggests that functionality and perceived benefits can supersede pre-existing notions of fashion itself. During the initial survey, many participants complained about acrylic nails for various reasons; however, after viewing the prototype and proposed applications, these same participants envisioned themselves wearing and using the device.

I probably, despite the fact that I don't put anything on my nails, would still at least try wearing [the fingernail device] because I think the conveniences outweigh whatever nail problems that I have (P14)

This is a ton of added value other than just the looks of it, so I think it's really, really, really worth having something on my nail, even though I'm not a big fan of that (P8).

I hate having long nails, but I probably wouldn't mind [wearing the fingernail device] because I feel like the benefits outweigh the cost (P1).

(After lamenting acrylic nails at the beginning of the study) I think if [the technology] were on acrylics, I would give them another shot (P11).

Incorporating technology into established fashion practice has potential to break down the boundaries of that practice, encouraging use among those previously excluded. Designers of fingernail technology should find balance between leveraging existing fashion practices and subverting them for more widespread acceptability. However, as I discuss next, technology alone is insufficient to deconstruct cultural biases and social norms regarding fashion practices.

Consideration of Cultural Biases and Social Norms: Four participants (all male) expressed that they had not painted or otherwise decorated their nails due to social norms and perceptions of femininity. Of these participants, 2 felt that the functionality was worth any social discomfort and that they would feel comfortable wearing it around. The other 2 participants maintained that they would feel uncomfortable, particularly in social situations.

We know this kind of stuff as "girl stuff". My friends probably wouldn't be very nice to me if I was wearing one of these. I think it's social acceptance. The idea of having something on my nails which is something that usually just [girls] do, it's somehow uncomfortable for me (P10).

For girls it's a lot easier. I don't know if it's becoming more normal for guys to wear false nails, but I've never had false nails so I don't know how they would look on me. I guess if I was past that barrier, it'd be nice to have and it'd be cool to have (P6).

While capturing a snapshot of perceptions, this design space exploration does not characterize how views on fingernail fashion and social norms would change over time in response to the emergence of fingernail technology. Emerging wearable technologies have always experienced a period of low social acceptance [47]. As with many new fashion trends, I envision social presence to promote social acceptance, and apprehension subsiding over time as fingernail technology floods sites such as Instagram⁵ and Weibo⁶. In turn, I also envision the emergence of fingernail technology to encourage broader social acceptance of existing nail fashion, challenging notions of who can and should participate.

4.8 Discussion

With the addition of a few small components at a key location, fingernail devices enable a richer vocabulary of interactions with technology and everyday objects alike.

E-ink display

The e-ink display used in all three prototypes consists of five addressable dots. This segmented display was chosen for its cost and availability in small quantity. Obviously, richer custom visual e-ink elements would yield more expressive overall designs. This constraint is commercial rather than technological. Tiny, intricate, and custom e-ink displays can be manufactured at low cost in large quantities. As *cosmetic computing* and wearable e-ink displays become more commonplace, I anticipate small, detailed, and custom e-ink displays to become more commercially available. This opens up a new range of potential interactions for fingernail devices, as well as other *cosmetic computing* platforms.

One vs Many

While many of the interactions require just one fingernail device, I envision users wearing multiple. Currently, the designed fingernail devices are individual and do not interact with each other; users have a separate nail for each function. In future iterations, I envision networked fingernail devices with complementary or paired designs and interactions. I also envision fingernail devices networking with traditional wearables, smart textiles, and other *cosmetic computing* devices to form an ecosystem of functional and fashionable wearables.

⁵<https://www.instagram.com>

⁶<https://www.weibo.com/>

Alternative sensors

The designed fingernail devices leverage an accelerometer to detect vibration patterns, distinguish between objects, and detect simple gestures; however, there are a number of different sensors and methods that could be used instead. The main constraint is that the sensor must be small and low-power. Within these constraints are light modulation and tilt detection to name a few. These further low-power sensing capabilities can create richer embodied interactions.

Advances in Wireless Power

While the presented fingernail devices are powered in close proximity to a power transmitter or NFC-enabled device, future iterations could leverage recent research into wireless charging at a distance [23]. As wireless power becomes more ubiquitous, technological constraints diminish. Assuming ubiquitous wireless power, fingernail sensors would be capable of continuous activity monitoring at high fidelity—much higher fidelity than current Smartwatch-based wearables. Additionally, the Internet of Things is constantly expanding [168] and NFC is becoming increasingly ubiquitous. Statistics show that in 2014 alone there were 277.5 million NFC-enabled mobile devices worldwide [43]. I imagine a future where every device is connected and capable of powering and communicating with passive wearable devices such as fingernail devices [207].

Advantages over current wearables

In addition to their subtle and always-available displays, fingernail devices provide several other advantages compared to traditional wearable devices. Fingernail devices can gather valuable information about what objects the user is interacting with, and how they are interacting with them. For example, a wrist worn device can detect if the user is near a Bluetooth enabled object. However, fingernail devices can distinguish whether or not the user is actually touching the object, and with which fingers. Fingernail devices also differ from existing wearable devices in that they can be customized both in fashion and function. As mentioned previously, a wide range of e-ink displays can be designed and manufactured. These displays of information can be either straightforward or ambiguous. For example, a new text message could trigger a “new text” display, or simply add another flower to an existing design. This versatility can enable both personal and shared interactions. Rather than traditional “one size fits all” found in many wearables, fingernail devices and other *cosmetic computing* platforms have the unique ability to fit within one’s sense of personal style.

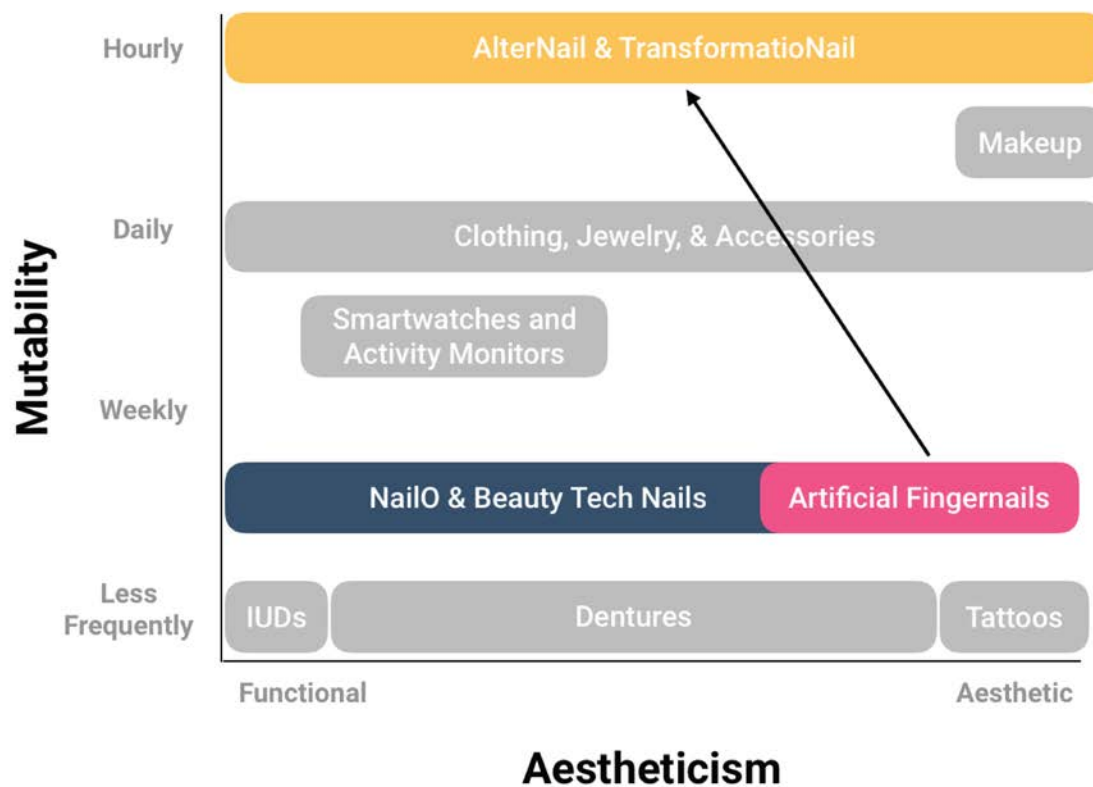

Figure 4.16: Aestheticism and Mutability of various body-worn artifacts. NailO [88] and Beauty Tech Nails [192] (shown in dark blue) expand the aestheticism of artificial fingernails to include additional functionalities, but maintain the mutability. In addition to expanding the aestheticism to include additional functionalities, AlterNail and TransformatioNail (shown in yellow) modify the mutability of the form factor, allowing aesthetic changes in a more frequent time frame. Traditional Artificial Fingernails are shown in pink.

Aestheticism and Mutability of Body-Worn Artifacts

Extracting *aestheticism* and *mutability* from the presented framework as parameters, we can plot existing and envisioned wearable artifacts within the space (See Figure 4.16). In terms of *mutability*, makeup, clothing, accessories, and hair are changed on a daily if not more frequent basis. Alternatively, form factors such as dentures and traditional tattoos are infrequently modified, if ever. In terms of aesthetics, tattoos and makeup are largely aesthetic; whereas, IUDs, dentures, and activity monitors are driven by functionality. Within this space, traditional artificial fingernails are more aesthetic than functional and modified infrequently: a set of acrylic nails lasts six to eight weeks [15]. Prior work (shown in dark blue) has explored artificial fingernails with additional functionalities, including touch and

RFID input to external devices [88, 192]. While expanding the functionality of the form factor, these works maintain the *mutability*; the aesthetics of the proposed devices are fixed and modified infrequently. While similarly embedding artificial fingernails with additional functionalities, AlterNail and TransformatioNail also modify the *mutability* of the form factor—embedded dynamic displays allow aesthetic changes at a much more frequent rate than traditional artificial fingernails and prior implementations.

4.9 Summary

This chapter identified artificial fingernails as a unique body-worn artifact in terms of *rigidity* and *removability* (See Figure 4.1). I further motivated the form factor through considerations of *aesthetics* (high visibility), *usage patterns* (intertwined in physical interactions), *interaction modalities* (private, discreet, one-handed, eyes-free, subtle, and quick) and *social & cultural considerations* (broad cultural acceptance).

I discussed the iterative design of three fingernail devices: AlterNail, AlterWear, and TransformatioNail. These wearable devices combine wireless power with e-ink displays to enable lightweight but expressive interactions with everyday objects. AlterNail used inductive coupling for power, and an accelerometer to identify special objects by unique vibration pattern. The AlterWear fingernail form factor leveraged NFC to combine power and object identification in a single channel, removing the accelerometer to reduce overall size. Also utilizing NFC, TransformatioNail reincorporated the accelerometer for lightweight gesture sensing, and leveraged custom memory organization to expand capabilities.

I described a design space exploration conducted to probe perceptions of fingernail technology. In addition to introducing participants to the TransformatioNail prototype, the study included two brainstorming activities and an informal interview. The design space exploration identified key considerations for finger placement of fingernail devices (relative dexterity, social appropriateness, size, and visibility), as well as themes regarding interaction (desire for “natural” and embodied interaction, distinction between conscious & automatic interactions) and themes regarding wearability (delicate balance of fashion and function, consideration of cultural biases and social norms).

This chapter demonstrated how the framework can be leveraged to surface opportunities for design specifically with regards to artificial fingernails, a body-worn artifact that is rigid and infrequently removed. The next chapter explores how the framework applies to a body-worn artifact with different characteristics with regards to these parameters: hair. Unlike rigid fingernails, hair is highly deformable. Depending on specific form factor, hair can be frequently removed (clip-in hair extensions, wigs, and hairpieces) or more permanent (weaves and natural hair). Hair is a particularly compelling body-worn artifact in terms of *interactivity*. These chapters serve to highlight how the framework can surface opportunities and challenges for diverse designs spanning a broad range of body locations.

Chapter 5

Interactive Hair

To further demonstrate how the framework can surface unexpected opportunities for technology on the body, I will now present another design that leverages another form factor not conventionally adopted in commercial markets: interactive hair extensions. This form factor was chosen to explore and expand *interactivity* as a compelling parameter of the presented framework. Hair is highly interactive and enables expressive interactions with the body (See Figure 5.1 for a projection of *visibility* and *interactivity*). Unlike smartwatches, activity monitors, and other commercially prevalent wearable devices that can only be tapped, swiped, or pinched, hair can be twirled, stroked, tousled, styled, pulled, braided, and interacted with in a variety of unique and embodied ways.

This chapter explores the affordances of hair and demonstrates how leveraging existing form factors with familiar interactions can facilitate embodied interaction and meaningful engagements with on-body technologies¹. This exploration of hair highlights how examining existing practices and usage patterns through the framework can surface embodied interaction modalities. To this end, I identify design considerations for *Heirloom* hair technologies, and leverage these in the design and fabrication of HÄirIÖ: interactive hair extensions. This chapter concludes with results from a user study conducted to garner thoughts and reactions to hair-based technology.

5.1 Introduction

Hair is a tangible and interactive extension of the body that allows for unique style interactions. The approach presented in this chapter is to directly engage with the natural and cultural affordances of hair as a material in wearable technology design. In many cultures and for many people, hair itself is both highly visible and ubiquitous. This allows people

¹Elements of this chapter were previously published in: Christine Dierk, Sarah Sterman, Molly Jane Pearce Nicholas, and Eric Paulos. 2018. HÄirIÖ: Human Hair as Interactive Material. In Proceedings of the Twelfth International Conference on Tangible, Embedded, and Embodied Interaction (TEI '18). Association for Computing Machinery, New York, NY, USA, 148–157. DOI:<https://doi.org/10.1145/3173225.3173232>

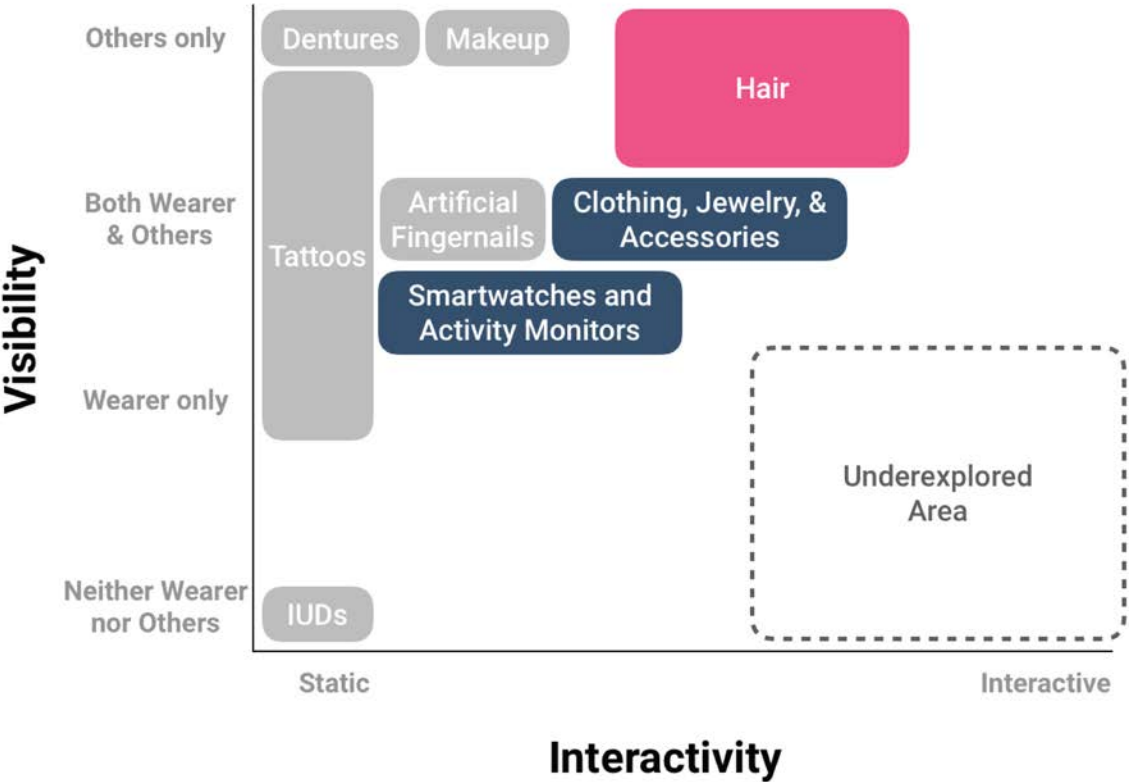

Figure 5.1: Visibility and Interactivity of various body-worn artifacts. Hair (shown in pink) occupies a unique location in the design space as a highly visible and interactive artifact. Most prevalent wearable form factors are shown in dark blue. While clothing, jewelry, accessories, and related artifacts are often visible to both the wearer and onlookers, hair is often only visible to others. In addition to motivating hair as an interesting location for wearable technology, this two dimensional projection of visibility and interactivity highlights an underexplored area for interactive technology with limited visibility.

to explore a range of public and private interactions using their hair. Taking inspiration from existing material properties and cultural meanings of hair, I present H airI ² — a hair-integrated technology that uses color and style as output, natural human touch as input, and makes use of commercially available hair extensions. H airI  is performative, yet personal. Movement can be seen by an audience, or felt only by the wearer.

There is a large landscape for potential interaction design within the rich cultural history of hair. I focus first on two of the most commonly-changed aspects of hair: color and shape. These output modalities enable a wide range of expressions both public and personal, leverage existing properties and form factors of hair to facilitate embodied interaction, and find inspiration in the wide diversity of existing hair colors and shapes. This makes them appropriate choices for an initial exploration of hair. While there are many other output modalities using materials such as electroluminescent materials, LEDs, etc., H airI  prototypes leverage Nitinol wire, commonly known as Shape Memory Alloy (SMA), and thermochromic pigments.

In this chapter, I define and explore new possibilities for hair-based wearables through the development of functional prototypes that capture and evaluate the expressiveness, interactivity, and social acceptability of hair technologies. In order to focus this exploration, I leave related issues of power, size, and additional materials to future work, and center the investigation into the ecology of hair. This work also sits at the intersection of traditional hair practices and wearable devices as an exemplar of *Cosmetic Computing*.

H airI  challenges gender norms and expectations of who can and how to style hair. It enhances the cultural positioning of hair as a statement of group and individual identity. It opens up a world of creativity and engagement with technology embodied in a familiar, intimate, transformative platform.

5.2 Related Work

Ambient, Ambiguous, & Abstract Displays

As technology continues to move towards the body and more diverse wearable technologies emerge, many designers and researchers have focused on creating wearable displays that are ambient, ambiguous, and abstract. New designs favor wearable displays that are subtle, slow-moving, and often ambiguous in meaning to onlookers, or even to users themselves [69]. Devendorf et al. identify and describe aspects of the complex relationship between computationally-controlled displays and personal style using thermochromic thread [38]. Other designs employ thermochromic pigments on skin [85, 84] to support rapid and early prototyping of cosmetic interfaces. Shape memory alloys have been used to explore animated, reactive, and interactive models of actuating textiles[13]. This work on H airI  extends these prior explorations in hybrid displays to a new domain: hair.

²H airI  is both a reference to hair as input/output and as a disruptive medium, since it is also a Finnish word meaning “disruption.”



Figure 5.2: A) HäirIÖ prototype prior to miniaturization, B) exemplar HäirIÖ hair accessory form factors, C) HäirIÖ uses Swept Frequency Capacitive Sensing to detect natural hair interactions, D) HäirIÖ color changing properties using thermochromic pigments, and E) shape changing properties using Nitinol wire.

Hair-Based Technologies

Previous work has explored the potential for hair extensions and wigs as input devices [183, 191], sites for embedded sensors [96, 183], and low-fidelity displays [185, 110]. HÄIRIÖ is most related to [185], where treated hair changes color in response to external temperatures, and Vega et. al’s Hairware, where chemically metalized hair extensions function as capacitive touch input [191]. The path forged by these two research groups lays the foundation for the fundamental building blocks of hair interaction. Building on this foundation, HÄIRIÖ presents a complete system in which input and output are combined and controlled. HÄIRIÖ expands output modalities presented in prior work by including shape change in addition to color change, internally actuating the changes, and incorporating capacitive touch sensing, informed by Vega et. al. By incorporating both input and output in a single braid, the presented system affords new interactions and applications previously unattainable. To enable future developments, I present cohesive guidelines for augmenting human hair with both input and output capabilities.

5.3 Design Considerations

Based on salient features of hair as a design site, I will now present design guidelines developed to shape contributions and inform explorations of the design space (Table 5.1). I envision the following as continuing the conversation around the design of on-body wearables, while incorporating the unique features of hair.

Public/Personal

The public/personal dichotomy focuses on looks or appearance of a new on-body technology (*aesthetics*). Hair is a powerful symbol of identity, and is often employed as an indicator of gender, age, status, and wealth [130, 188]. While speaking to one’s individual identity, hair also speaks to their group identity; monks, punks, hippies, skinheads, Rastafarians, and Beliebers all employ their hair as a means of expressing their identities and ideologies [178]. Hair is personal in that it is a part of the body, yet in many cultures it typically remains visible to the public. Because it is so often visible, hair may disappear into the background. This unique combination of highly visible yet inconspicuous makes on-body displays well-suited to a wide range of output modalities, and any technology that explores this space should consider the trade-offs along the public-personal continuum.

Malleability/Permanence

Hair is malleable, supporting temporary or permanent changes in length, color, and style (*mutability*). The use of artificial hair is established in both traditional and modern cosmetics. The practice is at least 5,000 years old, adopted by Ancient Egyptians, Romans, Queen Elizabeth, and the like [130]. As many cosmetic trends, artificial hair has persisted through

Themes and Guidelines
<p>Public / Personal</p> <ul style="list-style-type: none"> – Provide a range of output modalities from subtle to spectacular. – Allow for both hidden and highly visible designs.
<p>Malleability / Permanence</p> <ul style="list-style-type: none"> – Make removable. – Provide choice of when/how much to modify. – Enable both conscious and unconscious interactions.
<p>Social / Individual</p> <ul style="list-style-type: none"> – Create opportunities for both social and individual interactions.
<p>Embodied Interaction</p> <ul style="list-style-type: none"> – Leverage existing form factors.

Table 5.1: Design Guidelines for hair-based technologies.

modern times with the emergence of extensions, weaves, and modern toupees. Hair additions are culturally accepted, commercially available, and easily removed or interchanged (*removability*). The natural physical affordances of hair should inform the design of hair-worn technology, allowing for both unconscious and conscious interactions, and temporary or permanent installation. Any interfaces should be removable, allowing semi-permanent versions.

Social/Individual

The social/individual dichotomy relates to behavior of the user and wearable (compared with the private/public dichotomy which describes appearance). This on-body technology is individual, yet in some contexts, it becomes an intimate, shared platform for social bonding: between children braiding hair on a playground, or close friends expressing comfort or affection (*social & cultural considerations*). Individual use-cases should co-exist with collaborative and socially engaging ones.

Embodied Interaction

The many natural physical affordances of hair allow for a diverse range of interaction choices. Individuals have habits around their own hair; an embodied design leverages the user's existing gesture vocabulary and the physical affordances of their hair to integrate into their life and behavior (*usage patterns*). Hair can be straight, curly, kinky, wavy, and colorful; a design for the hair should be flexible enough to fit naturally into any kind of hair and any kind of behavior, merging the technology into the user's own bodily representation (*customizability*).

5.4 HÄIRIÖ

HÄIRIÖ augments hair with both touch input and visual output, using existing technologies and practices as a demonstration of the potential for *cosmetic computing* and hair as a unique platform for interaction. HÄIRIÖ uses thermochromic pigments and SMA to output visible change in color and shape, reflecting and enhancing the natural and cultural malleability of hair. This includes alternating between a natural color and a vibrant one, and between shaped and straight styling, creating publicly visible changes.

HÄIRIÖ also adds a new haptic dimension to personal interactions with hair: while people often touch their own hair, now their hair can touch them. Using shape changing capabilities, HÄIRIÖ can transmit subtle haptic communications by stroking or tapping. By shifting from the side of the face into the user's field of view, HÄIRIÖ provides lo-fi visual signals.

HÄIRIÖ uses Swept Frequency Capacitive Sensing to detect and interpret how users interact with the extension. Microcontrollers, sensors, Bluetooth modules, and other components are embedded in accessories or hidden in the hair itself. As such, HÄIRIÖ combines input with output, incorporates Smartphones and other devices into the interaction cycle, and creates novel, rich interactions. HÄIRIÖ provides guidelines with which designers, makers, and users can craft their own unique interactions and incorporate hair in new prototypes and designs.

Technical Architecture

HÄIRIÖ is a functional prototype that demonstrates the hair-based design guidelines presented above. Each individual HÄIRIÖ augmented braid has input and output capabilities. It is

controlled through a connection to a single central control board that can handle up to four braids at a time. While each braid can behave independently, more compelling interactions and applications are achieved by linking braid behaviors together, and connecting the on-board controller to other devices over wireless communication. What follows is a discussion of the technical choices and details of this prototype as informed by the design guidelines.

HäirIÖ consists of a central controller, a capacitive touch circuit, a power supply, multiple driver circuits, and swappable braids. Each braid with output capabilities has its own driver circuit to switch power on and off, but capacitive sensing can be handled by a single sensor circuit on the main control board by using multiplexing. The control circuit in this prototype can handle sensing and actuation on four braids at a time, based on the components chosen. Two modalities of output are implemented in the HäirIÖ prototypes: shape change and color change. The prototypes leverage SMA and thermochromic pigments (Table 5.2); materials which are capable of both subtle and spectacular changes (See Table 5.3 for example of a braid’s lifting capabilities). HäirIÖ braids can display one or both of the output modalities (color or shape change). Similarly, they can be configured for only input, only output, or integrated input/output. Integrating input and output in the same braid allows for new interaction behaviors that would be otherwise infeasible, such as immediate reactions to touch.

Material	Transition Temp	Width
Nitinol	46.1° C (115° F)	0.5mm
Thermochromic Pigments	31.1° C (88° F)	–

Table 5.2: Materials used in HäirIÖ. While the transition temperature of the Nitinol seems high in comparison to the average internal temperature of the human body (37° C/98.6° F), it poses no risk to the user or their hair [73]. Commercial hair straighteners operate between 93.3° C and 204.4° C (200° F and 400° F) [108]. In addition, both the user’s own hair and the hair extension provide a layer of insulation.

Heat

SMA and thermochromic pigments are both controlled through resistive heating. One battery powers the main control circuit, while a separate battery provides the resistive heating, to avoid current overloads. For safety and efficiency, power shut-off for output is controlled through a thermistor mounted inside the braid. The thermistor provides real-time temperature information, enabling closed-loop temperature control. This ensures both user safety and efficient operation, as the prototypes can shut down heating when the temperature exceeds a threshold. Pulse width modulation can be used to modify the time to transition, maintain a particular temperature (and resulting output), and prevent overheating the hair.

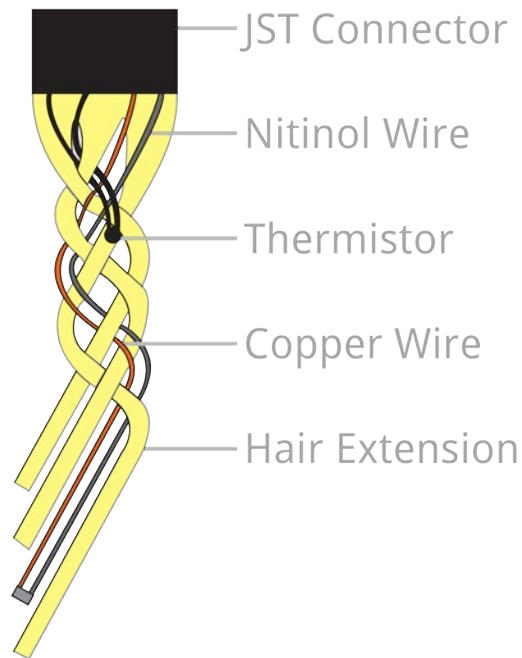

Figure 5.3: Diagram of a HäirIÖ braid. The connector at the top of the braid attaches directly to the driver circuit. The Nitinol and copper wires are soldered together at the end of the braid to make a single wire. The thermistor is woven into the braid to ensure accurate readings.

Ambient heat may also have an effect: thermochromic pigment may change color when exposed to environmental heat such as the sun, or physical touch due to its lower transition temperature (See Table 5.2). However, the transition temperature of the SMA is significantly higher, and in normal use will not actuate without additional power.

Sensing

HäirIÖ uses swept frequency capacitive sensing (SFCS), which has been shown to be capable of detecting multiple types of touches [159, 66]. The initial system implements the recognition of touch/no touch, but by implementing SFCS leaves room in future work for such gestures as stroking or twirling the hair. Sensing and actuation occur on the same wire. Combining input and output on a single wire requires a switching driver circuit that can disconnect the wire from both power and ground, as the capacitive electrode must be floating. When choosing transistors for this purpose, check the internal capacitance: the capacitance in field effect transistors will overwhelm the signal of the human body. Instead, HäirIÖ implements switching with bipolar junction transistors. Capacitive sensing requires some amount of

exposed wire. To achieve this, H airI  uses a four strand braid (Figure 5.3); however, there are many different types of braids and ways in which the wire can be incorporated. Additionally, there are other methods for sensing capacitive touch. For example, previous work has used chemically metalized hair extensions [191]. While SMA is still necessary for shape as an output, techniques such as metalized hair extensions extend the braid design space (e.g., completely concealing SMA within the braid).

Power requirements

The actuation power requirements of the initial prototype remain quite high, due to the heat needed. Typical operation on a $2\ \Omega$ braid wire draws approximately 1.5A (Figure 5.4). As discussed earlier, this chapter focuses on creating and evaluating novel interaction possibilities around hair; while functional and safe, reducing power draw was not a core goal of this work. However, several prototyped interactions take advantage of the bi-stable potential of SMA to produce shape and style changes that require short periods of actuation for long term effects, as discussed in Applications.

Current	Time	Angle Raised
1.5 A	2min35sec	84°
2.1 A	38sec	88°

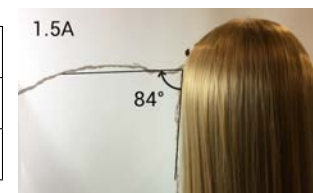

Table 5.3: Lifting capability of shape changing braids. The Nitinol begins hanging down, actuates to the listed angle, then relaxes to a resting angle of 44° after power is turned off. Braid specifications: 115° transition Nitinol with 0.75mm diameter, trained to a 90° bend; $1.0\ \Omega$; 50cm total braid length (42cm after bend); 4.9g total braid mass. Though this wire is a thicker gauge than the on-head prototypes, transition time behavior and lifting capabilities are comparable.

Customization and Communication

Each braid is constructed with a generic connector that allows one braid to be easily swapped for any other. A wide variety of behaviors can be encoded in the braids using shape and color change, allowing broad physical customization ranging from style change to haptic touch. Programmatic customization can change the control flows and timing of the behaviors. H airI  includes an integrated Bluetooth module to allow communication with other devices. Wearables often leverage mobile phones to handle the computational heavy-lifting of networking; with Bluetooth communication, H airI  can send user-generated data to other devices or apps, or react to information shared from other wearables, IoT devices, or other users.

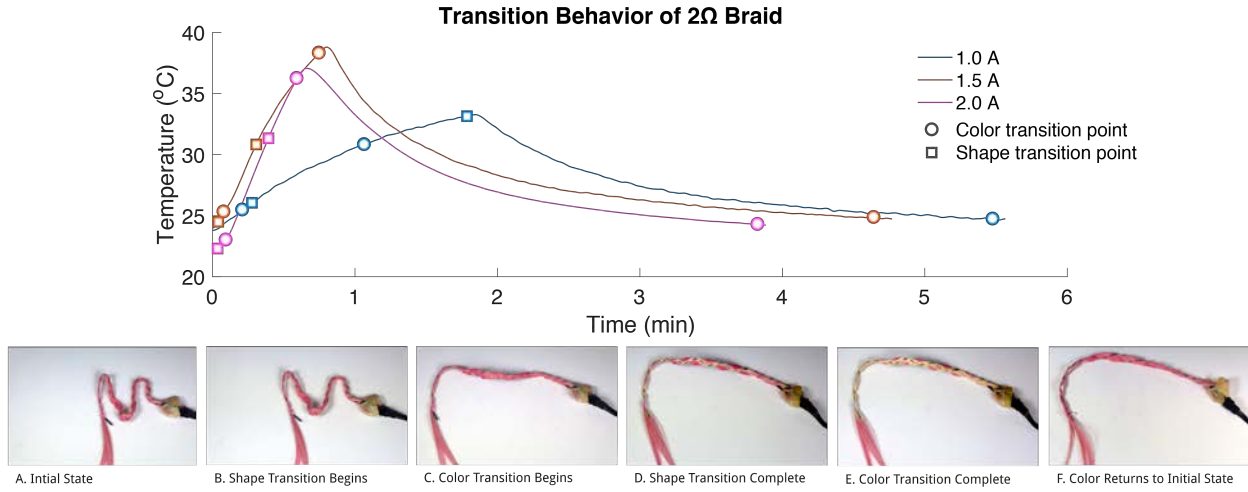

Figure 5.4: Transition behaviors for a H airI  braid with a resistance of 2Ω , at three operating currents; smoothed with a low pass filter. Typical worn operation uses a current draw of 1.5A. Photos of the braid in each transition state are of H airI  braid with a resistance of 2Ω at an operating current of 2.0 A; however, braids at different currents demonstrate similar effects. Note that the insulating properties of the hair affect when transitions occur; the ordering of shape and color events in transition pairs (B,C) and (D,E) switch in the 1.0A case.

Transition Behaviors

The time to transition and order of transition events are key features in designing interactions. The insulating properties of natural and synthetic hair extensions mean that the outside of the hair does not heat in direct synchrony with the internal wire, leading to a more gradual color transition and varying event orderings. To enable future designers, I present a model of the dynamics of the heat energies of Nitinol (Q_n) and hair (Q_h):

$$\begin{aligned} \dot{Q}_n &= P(t) - \frac{T_n - T_h}{R_1} & T_n &= Q_n / C_n & R_1 &= 9.1K/W \\ \dot{Q}_h &= \frac{T_n - T_h}{R_1} - \frac{T_h}{R_2} & T_h &= Q_h / C_h & R_2 &= 16K/W \\ & & T_t &= A * T_n & & \end{aligned}$$

$P(t)$ is the electrical power input; T_n and T_h are the temperatures of the Nitinol and the hair, while T_t is the measured temperature at the thermistor. The parameters R_1 and R_2 are the thermal resistance of the Nitinol to the hair, and the hair to surrounding air, respectively. These values are determined through a least-squares regression on the experimental data represented in Figure 5.4.

These equations can be used to design approximate transition behavior based on available

power input. Further tuning may be required given different braid construction or hair properties. These parameters were fit to data collected on a braid with 4g of bleached human hair, and 33cm of 0.5mm diameter Nitinol. Heat capacities C_n and C_h can be calculated from the specific heats of hair [148] and Nitinol. A , the relation between the thermistor readings, Nitinol temperature, and ambient temperature, is calculated in the system to be $A = 4/11$; this will vary based on braid construction.

Hair Extensions

The first obvious consideration for choosing hair extensions is hair color and style. Consumer hair extensions are available in all natural hair colors and seemingly endless unnatural ones. They can be purchased curly, wavy, straight, and in various lengths. While paramount to intended effect and applications, the color and style of the hair extensions has minimal technical implications. Another consideration is choosing synthetic or real hair extensions. Synthetic extensions are cheaper, and are available in a wider variety of colors and styles; however, real hair extensions feel more natural to the user (see User Study) and are more robust at high temperatures. For long term applications, a user's own hair can be used instead of extensions, as long as the circuitry is protected from water.

Proposed Applications

HäirIÖ leverages the unique characteristics of human hair to enable many classes of interactions. I present here a selection of proposed use cases for the initial HäirIÖ prototype. These applications are discussed in light of perceptions and reactions from participants in a user study, described in the next section.

Notifications

State changes on the head and near the face enable a wide range of notification capabilities. Depending on the location of the braid, some HäirIÖ outputs may not be visible to the user without the use of a mirror. These outputs lend themselves to unobtrusive updates and notifications that will not distract the user until they actively look for them. Besides these inconspicuous outputs, the hair can provide more intrusive outputs such as by moving itself into the user's field of view. By changing its shape, a strand of hair tucked away might slide into peripheral vision (Figure 5.5). This could be used for spatiotemporal cues, including hands-free navigation: the side of the head on which the hair moves would indicate the direction to turn. Participants in the conducted user study universally responded positively to this application idea, and could imagine such an interface being useful in their everyday lives.

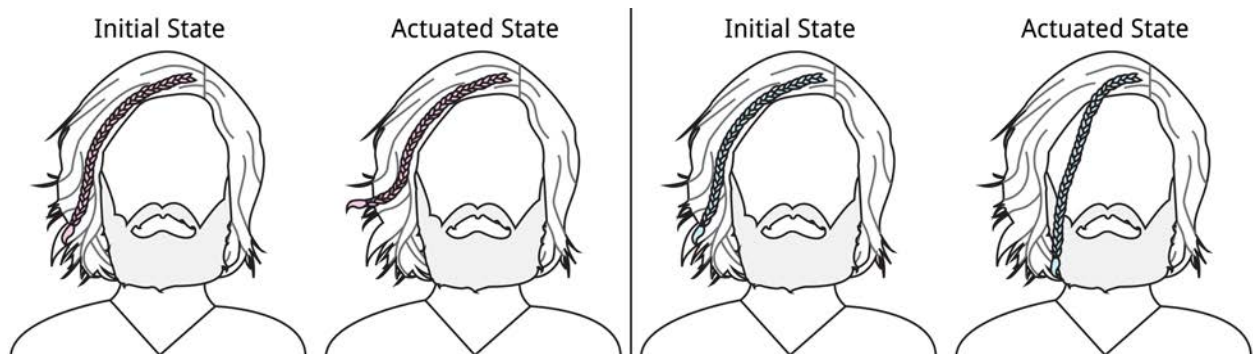

Figure 5.5: Illustration of two subtle notifications. Left: the actuated braid lifts slightly, protruding from the side of the head. Right: the actuated braid shifts into peripheral view. While the user would notice these subtle movements of their hair, onlookers are unlikely to notice the changes, and would likely attribute them to natural hair movement.

Haptics

The shape-changing capability of the HÄIRIÖ braids provides both a visual and a tactile output, as the hair moves against the skin during the transition time. A HÄIRIÖ braid curling subtly behind the ear might not be visible to the user or an observer, but can be calibrated to be clearly felt on sensitive skin (Table 5.4). This can be used as an invisible, silent notification, acknowledged through capacitive sensing when the user smooths out the curl. Or, a curl may straighten itself, gently tapping a user on the shoulder or brushing their neck (Figure 5.7). Depending on how the hair is heated, the movement of the notification can vary – a little heat for a subtle shift, and greater heat for a more dramatic change. This variation can be achieved on the same braid, without physical modifications.

Most participants in the conducted user study noted that for someone who wishes to disconnect from the screen but is expecting particularly urgent messages, this kind of notification system could be very useful. Haptic interactions can extend to other use cases as well: consider a scary story enhanced by the faint tickle of hair on the back of your neck, or a comforting touch transmitted by a friend far away (Figure 5.6).

Public Display

Hair is often dyed and colored prior to special events. HÄIRIÖ confers the ability to change hair dynamically at a party or event for a more unique hair display. Changes in the braids were universally described by participants in the user study as engaging, eye-catching, and interesting. Even a series of individual, small changes were considered intriguing to most participants in the conducted user study, not just single dramatic events. During a conversation, the slow change would eventually become noticeable, prompting delight and a sense of whimsy. Changing hair might be incorporated into an intimate stage production, such

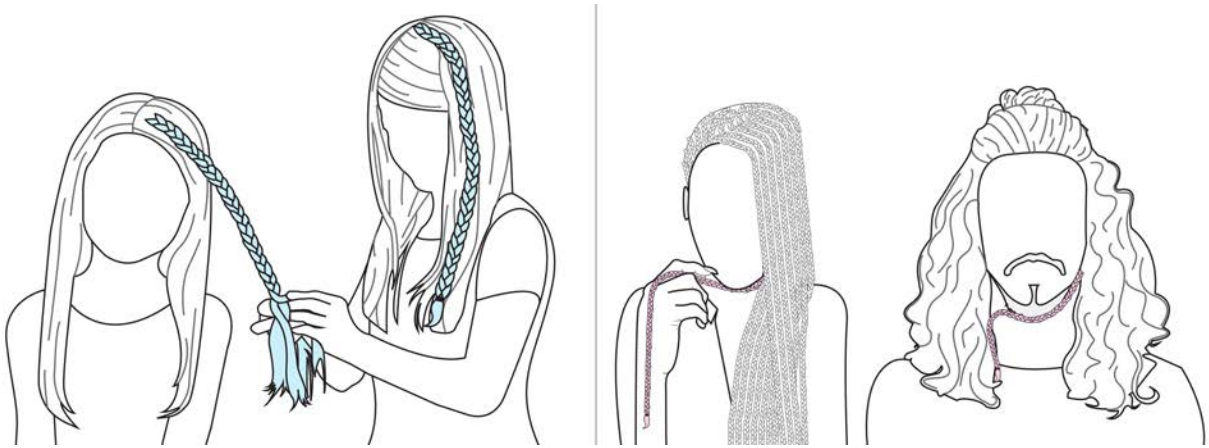

Figure 5.6: Illustration of two social applications of HÄIRIÖ . Left: interacting with a friend’s HÄIRIÖ braid could change the color of one of your own braids. Right: Manipulating a HÄIRIÖ braid could cause a friend’s braid to move in the same way. This application could be used for sending discreet messages during meetings, or for sending haptic messages to someone not collocated.

as a concert or a dramatic show. One participant in the conducted user study imagined these kinds of playful displays making a big impact at a children’s birthday party. Another participant suggested hair could be programmed to indicate current weather conditions, or respond to mood.

With their location atop the head, HÄIRIÖ braids are sometimes more visible to onlookers than to the users themselves. This characteristic can be used to inform both public displays and social interactions. One participant in the user study imagined a kind of encoded side-channel: for example, hair could curl or straighten, communicating a pre-defined message during a negotiation.

Social Engagement

Interpersonal touch in hair can be both playful and intimate. Integrating input and output capabilities on the same HÄIRIÖ strand enables new forms of social touch. Imagine a child’s braid that changes color as a friend braids it, then fades back when the interaction ends. Or imagine it maintains its color – a color unique to the friend who shaped it. Perhaps a touch on the hair causes a shape change, which invites a new touch, continuing a responsive interaction. These interactions are distinct from isolated input or output: providing immediate feedback and direct output in the same interface creates a complete, self-contained world of interactions (Figure 5.6).



Figure 5.7: Physical implementation of application. H airI  braid is twisted around a bun. Upon actuation, the braid begins to straighten out, unwrapping from the bun and falling on the user’s shoulder. A second wire unravels similarly, and the entire bun falls down. This technique also employs haptics, as the hair movement elicits a tactile sensation.

Style Changes

A final application is to enable low effort, high impact, extremely flexible hair styling. Using the bi-stable nature of SMA, H airI  can use power only during the transition time, after which the braid will retain its new shape. Perhaps a user wants curly hair on Friday, but only to have color for the evening. Leveraging the individual strand control, the hair might change slowly over the day to build up to an exciting night-time style.

H airI  can also use static elements, such as hair accessories and buns, to add further bi-stable features to H airI  braids. For instance, a powered braid may lift and wrap around a hair clip. When the SMA is no longer being actuated and the braid releases, the static clip holds the braid in its transitioned state. Alternatively, a H airI  braid may be twisted around a bun. Upon actuation, the braid could straighten out, unwrap from the bun, and fall upon the user’s shoulder (Figure 5.7).

Limitations & Future Directions

The current instantiation of H airI  has several practical limitations. The high power draw of the resistive heating reduces battery life, requiring frequent recharging. The heat-based actuations require careful monitoring to keep the temperatures within a comfortable range. The thermochromic pigments are not bistable and require continuous power to maintain the actuated state. Since the SMA is not currently insulated, sweat or other water could potentially cause a user to feel a tingling sensation, but this is similar to conductive thread under the same conditions. Though the size of the device can be easily reduced with smaller electronics, the size is ultimately constrained by the power source. Capacitive touch input was implemented as a proof of concept. As such, there are many limitations to the approach. H airI  was designed, implemented, and tested in the same laboratory under the same con-

ditions; a calibration method is needed to generalize results. Furthermore, HÄIRIÖ braids are susceptible to parasitic capacitance in applications and configurations in which the braids are in direct contact with the user’s neck, face, or other exposed skin. In these cases, HÄIRIÖ braids are liable to detect false positives for user touches. In addition, frequency of accidental touches would need to be characterized to fully assess integration into daily life, but different braiding techniques and locations could solve a variety of issues in this domain.

The current prototype uses a chalking method to apply thermochromic pigments to the braids [211]; in future iterations, I hope to utilize existing cosmetic practices to chemically dye the extensions with these pigments. If waterproofed and safely enclosed, HÄIRIÖ configurations could be braided into natural hair and kept/maintained for a period of time (days/weeks) such as cornrows, weaves, and other more permanent hairstyles (*removability*).

While this work has tended to focus on Western styles and traditionally white hair, there are incredibly rich traditions of African braiding, weaving, and styling. Future work must expand to include other hair types, and to contextualize it within non-Western styles. I also imagine the incorporation into facial hair, such as long beards or ornate mustaches.

5.5 User Study

I will now present results from a user study conducted with eleven participants to garner thoughts and reactions to HÄIRIÖ and hair-based technologies more generally.

Participants

Each participant had some experience styling, braiding, and touching hair (avg. age 29 yrs, 8 Female) as reported in a preliminary survey. All users had changed their hair color at least once, styled it regularly, and all but one rated themselves as proficient at French braiding, a common but more complex maneuver.

Participants were recruited from University and local mailing lists and invited to a studio location for an hour-long workshop. They were compensated at the rate of \$20/hour. Participants were asked about their background experience with hair fashion and wearables. Participants were then invited to interact with several prototypes. These prototypes included a range of output braids, an integrated input/output braid with Bluetooth capability, and two wearable braids with specific applications: a haptic notification in which the braid subtly curls behind the users ear, and a lo-fi visual notification in which the braid slowly moves into the users field of vision. These applications are described in more detail in the previous section. Participants were encouraged to touch and stroke the braids, and given the option to wear the prototypes. The study concluded with an informal interview, a brainstorming activity, and assessment questionnaires.

Survey Results

Users reported their experience with the prototypes by answering questions on a five-point semantically anchored Likert scale (1=Strongly Agree, 5=Strongly Disagree).

Noticeability		Experience	
Ear curl	Enter FOV	Comfort	Safety
3.25 ± 1.4	3 ± 1.4	1.875 ± 0.6	1.1 ± 0.4

Table 5.4: Qualitative ranking by participants of noticeability of notification interactions, and comfort and safety.

Users rated the wearable demo as extremely comfortable and perceived it as safe. When asked to rate how safe the demos felt, all participants rated them as very safe, and no participants mentioned any discomfort from the hair interface. In fact, one participant vocalized that she expected the interface to be uncomfortable, but was pleasantly surprised by how natural it felt. The two wearable notifications received middling scores for noticeability: half of the users gave very low ratings, and half gave very high ratings. Those who didn't feel the behind-ear curling theorized that it was due to ear shape, the stems of their glasses interfering, or them moving the demo as it actuated. Those who rated the touch as highly noticeable emphasized that they “definitely would notice it”. The behind-ear notification could easily be made much more dramatic, and can and should be tailored to a particular user's ear shape and around other accessories (such as glasses). Similar considerations hold for the visual notification.

Qualitative Findings

I first report survey responses (see Table 5.4), then present qualitative results from participant interactions with the wearable demos, and finally discuss interview responses from the end of the study. These findings are synthesized into common themes and insights for future hair-based technologies.

Embodied Interaction

All of the participants emphasized that the way the technology disappeared into existing form factors was very appealing. The following user immediately began twirling the hair around her fingers, as she would her real hair, saying:

It doesn't feel unnatural. My body is just immediately accepting of it, like, “yes, I'd like to play with it now.” My body definitely keyed into it naturally: “Oh, hair.” (P1)

It seems like it's a part of you (P6).

In particular, participants appreciated the familiarity of the hair as a way to enhance the experience of the technology:

Wearables can enhance your own experience of yourself (P6).

It's like a bridge between myself and the phone (P7).

All participants confirmed that the enhanced hair felt natural and pleasantly soft.

Social/Individual

Because hair is one of the only body parts it's acceptable to interact with on another person, the shared experiences made possible by HÄIRIÖ were especially appealing to some:

The way you swapped the braids out, it makes me think of a tradeable collectable item. I could make a braid, program it and give it to my friend who could wear it and find out what it does (P5).

In general, when participants described interacting with other people's hair it was in extremely positive and prosocial terms:

Braiding somebody's hair is more like an act of care. Something you're doing because you want to do something nice for somebody (P4).

A participant with experience working with middle-school aged girls thought that her students would immediately be drawn to the hair as a way to connect socially:

Girls that age do hair-braiding and touching as emotional and social connection (P2).

[These are] really honing in on how people react with each other, and how [they] encourage touch and creativity (P3).

For some, the subtler versions of HÄIRIÖ were more appealing. Some participants liked the idea of a secretive control to surprise friends with a hidden interface control.

This kind of control interface would be so hard to spot. The motion is so natural, it's so stealth (P7).

Participants emphasized that they would sometimes like the programmed behavior to be hidden from most observers. One participant suggested that she could use the technology to train herself out of the habit of touching her hair, since she saw that as unprofessional. She did not want it to be obvious that her hair was tracking how often it was touched, and so appreciated the subtle design of the interface.

Public/Personal

From parties and costume festivals to avoiding judgment in an exercise class, participants imagined a variety of use-cases along the public-personal continuum. The majority of participants were particularly drawn to the subtle and hidden nature of hair-worn wearable technology. One participant commented on the use of inconspicuous technology as a useful tool in managing social expectations and norms around technology use. Subtlety allows for navigation of the complex social expectations that have evolved around the increasingly many ways to stay connected:

I don't want them to see me responding faster to [a text message from] someone else than I do to [a text message from] them (P8).

The surreptitious nature of the interface allowed a user to take an action without offending a friend or acquaintance. One user imagined being able to silence her phone during an exercise class, without the typical social judgment she would feel for running over to turn it off.

More than half of participants also preferred the more subtle possibilities for technology embedded in something as ubiquitous as hair. Several users' preferred display type was highly contextual, and contingent on their mood, the environment, and their goals.

The ability to vary how publicly visible HÄIRÖ was allowed the technology to be imagined as integrating into a wide variety of settings, from meetings to long car rides, to parties. One saw the ability of the technology to control appearance as a potential opportunity for creating a cohesive experience at a party event:

It would be amazing if you went to the party and your hair matched the theme of the party. Matched the shape or size or color and everyone in the party was doing the same thing (P7).

Hair is a site for personal expression and style exploration and many participants immediately perceived HÄIRÖ as a natural extension of that potential. They began imagining HÄIRÖ as another way to experiment with different styles. All participants envisioned the hair autonomously changing color throughout the day, emphasizing how changing hairstyles affects others' perceptions of oneself. All users expressed interest in the ability to flexibly incorporate these kinds of changes into everyday life.

You can't tell that it's technology but it is, so you can integrate it into your outfit (P9).

Some participants exclusively wanted to use their hair for style or identity expression:

For me hair is more an expression to everybody else, rather than it telling you to do things (P11).

All participants recognized the potential for HÄIRIÖ as an engaging and eye-catching display, and imagined incorporating it into stage productions.

As the frolicking innocent character enters with the creepy demon and the hair starts changing and she doesn't notice until she gets to the mirror - but the audience is seeing it (P2).

One user imagined a specific, spectacular use-case for the hair:

Drag Queens would definitely use it. They'd walk down the runway and change the color while they're going, for the spectacle of it (P1).

Malleability/Permanence

Several participants commented on the fact that hair is a performative expression of an identity. The ability to rapidly (over the course of a day) experiment with different appearances appealed to all participants. The fact that one's hair was quickly changing would in itself become part of the identity one was performing, not just the changes themselves.

I'm just imagining going into the bathroom with straight hair and coming out with curly hair...When you change something about your appearance, you can be perceived in a different way (P10).

One participant commented that the extensions could be used by a developing child as a way to experiment with their growing sense of identity, and specifically focused on the temporary nature of HÄIRIÖ as an important piece of that exploration.

I could see something like this being an extension of [gender expression]: he wants to put on his princess dress and his sparkly braid that curls (P3).

Overall, users expressed excitement and curiosity about the hair displays, and were intrigued by the potential use-cases. The intimate nature of technology that physically blends into the body seemed particularly compelling to users, who appreciated both the possibility of a subtle interface, and the potential for more eye-catching displays.

5.6 Discussion

Extracting *communicative reach* and *activation* from the presented framework as parameters, we can examine various hair artifacts (See Figure 5.8). Unaugmented hair requires manual activation, meaning that modifications to style and functionality are performed manually by the wearer. The communicative reach of unaugmented hair is constrained by the limitations of human sight. As mentioned previously, HÄIRIÖ is most related to FIRE [185], and Vega et al.'s Hairware [191]. Hairware extends the communicative reach of hair by enabling natural

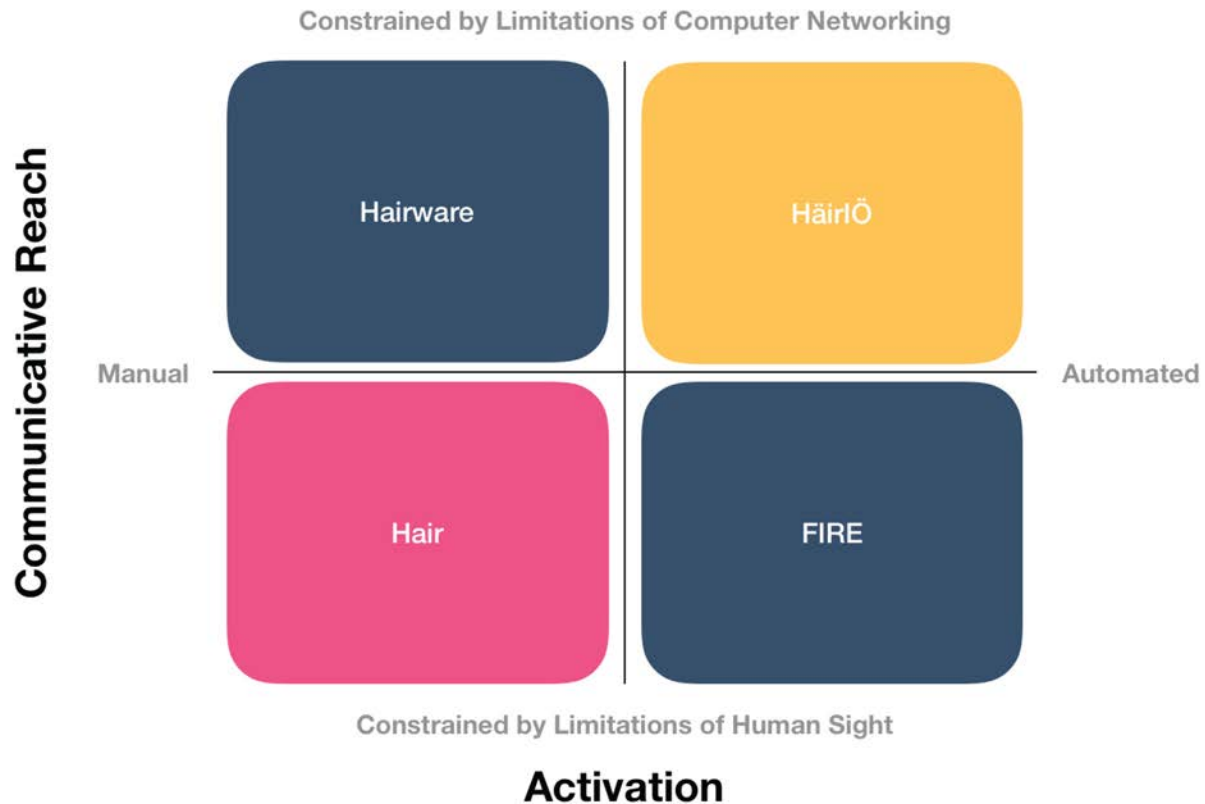

Figure 5.8: Communicative Reach and Activation of HÄirIÖ, Hairware [191], FIRE [185], and unaugmented hair.

hair touches to control external devices, potentially communicating with distant friends or colleagues; however, the implementation maintains the need for manual activation. FIRE automates the activation of hair, allowing it to change color autonomously in response to external temperature; however, the prototype maintains the limited communicative reach of unaugmented hair. HÄirIÖ extends the communicative reach of hair while automating the activation, allowing for autonomous style and color changes.

I envision a world where the entire head can be responsive, autonomous, performative, or subtle. Hair that could style itself, effortlessly adjusting in response to the outside world, or computationally generating new, previously impossible fashions. It would also be possible to have someone else style one's hair, which is then remembered and replayed by the hair itself at a later time. The hair might have functional roles, such as extending into a context-dependent cellphone antenna.

I imagine a differentiated assortment of interchangeable braid designs that easily integrate and swap, and app infrastructure to allow individuals to author their own hair designs, surprising friends. I envision location-specific hairstyles that automatically adjust themselves.

Beyond color and shape, I imagine a broad range of changing output options: polarized light, electroluminescence, and other displays. These display options could also easily be incorporated into other hair-like objects. A stuffed animal or shaggy wall-hanging could move or change color as part of an ambient or interactive display. Fringed clothing, shoelaces, ribbons, even cables could potentially be actuated or color-changing.

5.7 Summary

This chapter explored hair as a unique body-worn artifact in terms of *visibility* and *interactivity* (See Figure 5.1). I highlighted key design considerations for hair technologies related to *aesthetics* (public/personal), *mutability* (malleability/permanence), *removability* (malleability/permanence), *social & cultural considerations* (social/individual), *usage patterns* (embodied interaction), and *customizability* (embodied interaction). Existing *usage patterns* and *social & cultural considerations* informed appropriate expressive outputs of color and shape.

I discussed the design and fabrication of HÄIRIÖ: interactive hair extensions. HÄIRIÖ braids use Swept Frequency Capacitive Sensing to leverage natural and embodied gestures with hair as input to technological systems. In terms of expressive output, HÄIRIÖ braids leverage thermochromic pigments to enact color change, and Shape Memory Alloy (SMA) to enable shape change and haptic feedback.

I described a user study conducted to garner thoughts and reactions to HÄIRIÖ and hair-based technology more generally. In addition to introducing participants to several HÄIRIÖ prototypes, the study included an informal interview, a brainstorming activity, and assessment questionnaires. The user study revealed key insights relevant to the design of hair-based technologies. Participants expressed a desire for a broad range of hair-based interactions and technologies—from personal to public, individual to social, functional to aesthetic, subtle to spectacular. In particular, participants responded positively to embodied interaction enabled through interactive hair.

This chapter explored the affordances of hair and examined *interactivity* as a compelling parameter of the framework. The next chapter explores *maintenance* as a theme, detailing the design of low-maintenance *Heirloom Wearable* technology in the form of clothing & various accessories. These chapters continue to demonstrate how the framework can identify opportunities and challenges for new wearable technologies designed across the landscape of body-worn artifacts.

Chapter 6

Dynamic Clothing and Accessories

Another key distinction across the broad landscape of body-worn artifacts is the amount of effort required to maintain the artifact (See Figure 6.1 for a two dimensional projection of required *maintenance* and *removability* of various body-worn artifacts). Some body-worn artifacts, such as tattoos and IUDs, are low maintenance and require little effort from the wearer once they have been applied to the body. Other body-worn artifacts, such as dentures and hair, are higher maintenance and require frequent effort from the wearer to maintain: in the case of dentures, brushing, flossing, and semi-annual trips to the dentist; for hair, brushing, styling, washing, and cutting. Requiring frequent charging, updates, and attention to notifications, traditional wearable technologies such as smartwatches, activity monitors, and data glasses (e.g., Google Glass) are high maintenance. In this chapter, I focus on a specific class of wearables that do not need to be charged, cared for, or even removed — AlterWear¹.

Taking the form of clothing (a tee shirt), accessories (hats and shoes), and cosmetics (artificial fingernails), AlterWear takes inspiration from existing *usage patterns* of these body-worn artifacts, particularly with regards to *maintenance*. Aside from laundering (clothing), infrequent spot cleaning (hats & sneakers), and painting/filling (artificial fingernails), these body-worn artifacts require little effort from the wearer to maintain. Adopting these existing usage patterns, AlterWear artifacts are similarly low maintenance, and do not require programming, charging, or other maintenance characteristic of existing wearable technologies.

Throughout this chapter, I highlight the unique affordances and emerging interaction modalities of low-maintenance wearable technology. I present six AlterWear prototypes to demonstrate how a particular functionality can be embodied in a variety of body-worn artifacts with varying physical form, usage patterns, and cultural connotations. This chapter concludes with a user study conducted to probe perceptions of low-maintenance dynamic wearable displays.

¹Elements of this chapter were previously published in: Christine Dierk, Molly Jane Pearce Nicholas, and Eric Paulos. 2018. AlterWear: Battery-Free Wearable Displays for Opportunistic Interactions. In Proceedings of the 2018 CHI Conference on Human Factors in Computing Systems (CHI '18). Association for Computing Machinery, New York, NY, USA, Paper 220, 1–11. DOI:<https://doi.org/10.1145/3173574.3173794>

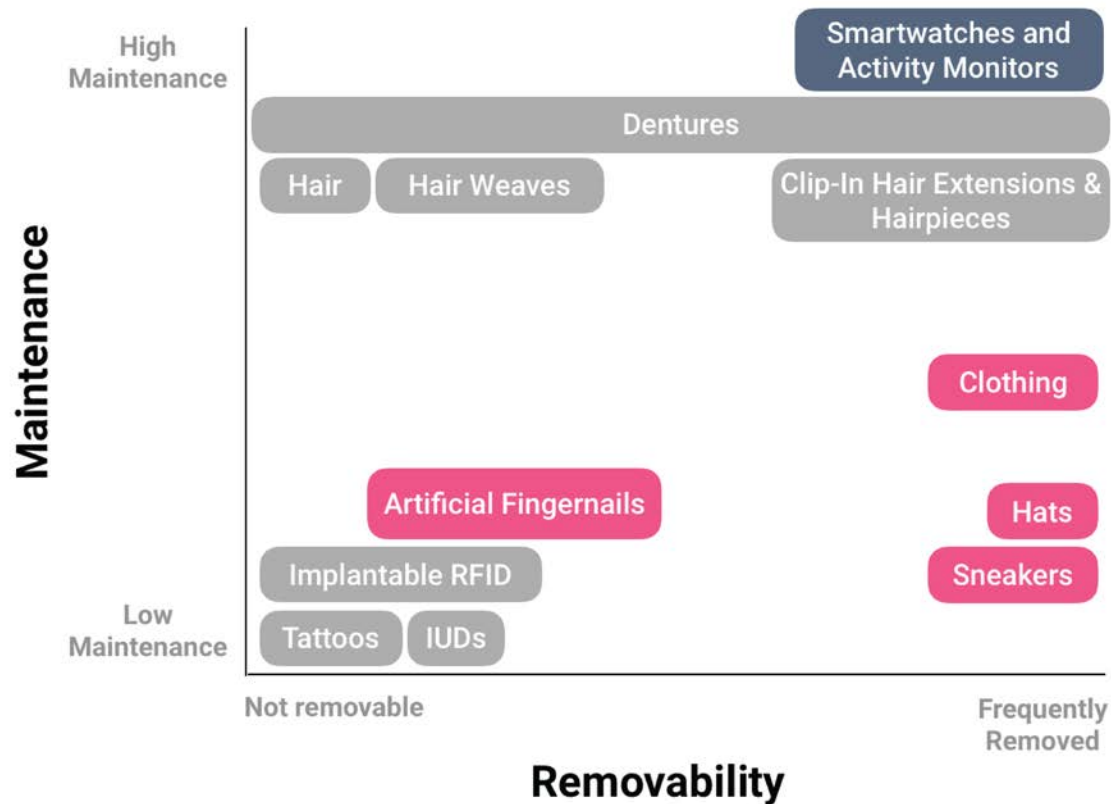

Figure 6.1: Removability and Maintenance of various body worn artifacts. Existing wearable technologies (highlighted in dark blue) are high maintenance, requiring frequent charging, updates, and attention to notifications. Implemented AlterWear artifacts are highlighted in pink.

6.1 Introduction

The number of commercial wearable devices is constantly expanding to include new functionalities, form factors, and affordances. These wearable devices aim to make life easier by tracking fitness and health, improving connectedness and communication, and simply entertaining the user. While many devices are effective to this end, a majority of existing wearable devices retain the need for some source of on-board power, imposing an additional responsibility on users to charge, care for, and maintain. Wearable devices also often demand attention with persistent updates and notifications. Research has shown that regardless of whether a user intends to respond to their device, notifications alone are capable of increasing cognitive load and decreasing task performance [173].

Mark Weiser envisioned ubiquitous computing as disappearing into the background [207]; however, this is impossible if the user must remove and charge their wearable devices on a

daily or even weekly basis. Taking power constraints and considerations out of the wearable itself, AlterWear allows wearable technology to slip into the background. Users can wear AlterWear on a daily basis, updating as frequently or infrequently as they like (*mutability*). If properly enclosed (See Figure 6.11), AlterWear could endure trips through the washing machine, inclement weather, and other wear and tear consistent with existing clothing and accessories. While AlterWear’s functionality is limited, this is intentional so that users do not have to worry about programming the devices, installing updates, syncing with additional devices, or removing to charge. AlterWear proposes a restructuring of human-device relationships by creating intentionally unobtrusive wearables that are low maintenance, do not need to be charged, and only provide updates on request. Explicitly designed around these particular constraints, AlterWear enables a set of unique interactions.

6.2 Related Work

Prior work has addressed the issue of power in wearable systems. Some new wearables resolve power constraints by leveraging chemical interactions rather than electrical ones [86, 137]. Other work has harvested energy from human motion [102], public landscapes [143], personal objects [147], and radio frequencies [141, 180]. Another way to address limited power resources is to lower power requirements. Prior work has leveraged the bi-stable, low-power nature of e-ink displays in battery-free devices that use photovoltaic energy [56] or wireless power [36, 226]. AlterWear contributes to this body of work by presenting a diverse array of wearable form factors that require no battery, yet have a persistent bistable display, and leverage the increasing ubiquity of wireless power.

AlterWear is also related to prior work on situated displays that argues that information is more meaningful when displayed in contextually relevant locations [56, 206, 138]. In addition to designing contextually, many researchers and designers alike have also opted towards ambient, ambiguous, and abstract displays [38, 69]. AlterWear expands this body of work by presenting additional form factors for displays that are subtle, intentionally unobtrusive, and often ambiguous in meaning. The work presented in this chapter also contributes to the expanding understanding of users’ perceptions of wearable displays, synthesizing findings from a user evaluation, and presenting design guidelines for creating battery-free wearable displays.

6.3 AlterWear

AlterWear combines NFC and e-ink technologies to enable battery-free, dynamic wearable displays. These displays can be incorporated into a number of different form factors, and fuse interaction, information, and fashion while remaining lightweight and low maintenance. Six AlterWear prototypes were designed and fabricated, leveraging diverse body-worn artifacts with varying affordances, including *accessibility* and *visibility* (See Figure 6.2). AlterWear

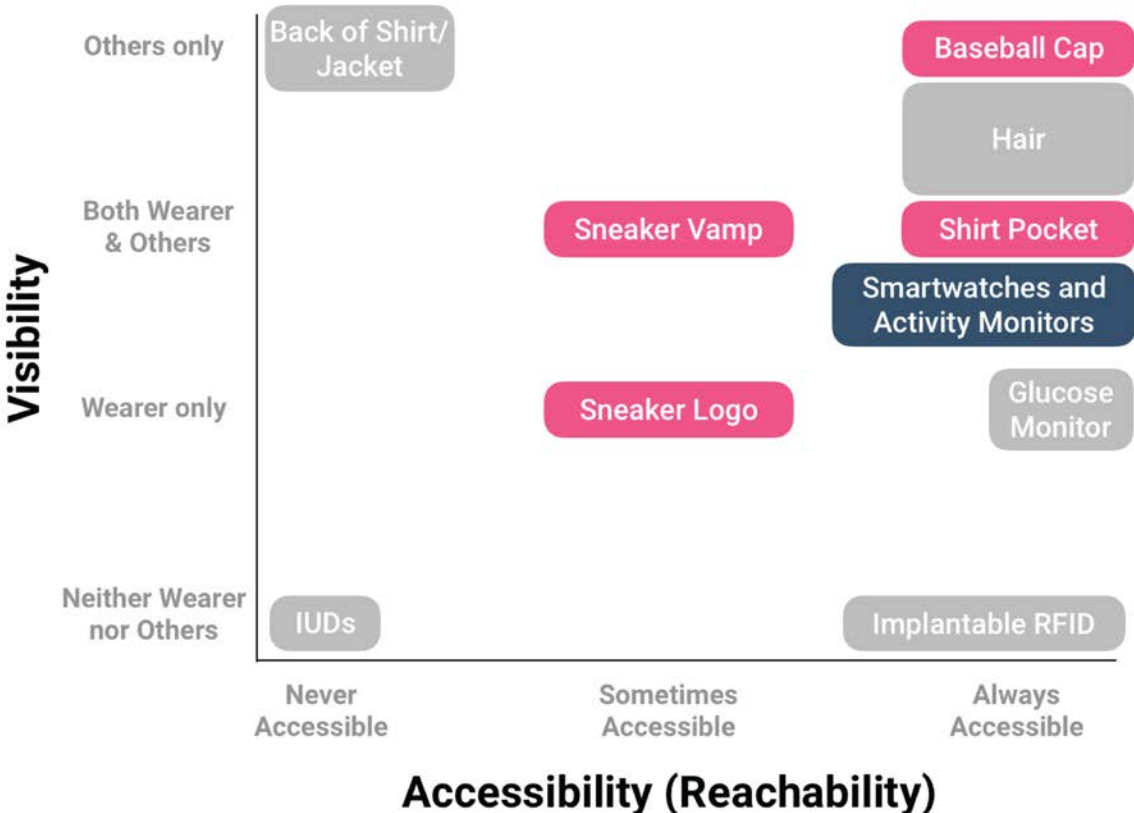

Figure 6.2: Visibility and Accessibility (Reachability) of various body-worn artifacts. Shown in pink are implemented AlterWear prototypes; artificial fingernails are co-located with shirt pocket, always accessible and visible to both the wearer and others; both baseball cap prototypes are co-located, always accessible but only visible to others. Shown in dark blue are prevalent wearables. Implantable RFIDs are always accessible, but never visible [101]. While accessible by medical professionals, IUDs are never accessible to the wearer. Locations on the shoe depend on body posture and are therefore “sometimes accessible”. Future work should explore AlterWear interactions in body locations that are never accessible, such as the back of a shirt or jacket.



Figure 6.3: Three AlterWear prototypes. Note how well the technology is integrated into the garments. Left: Tee shirt pocket display (i.e., pattern). Middle: Segmented hat display (i.e., stars). Right: Discreet sneaker display (i.e., Catverse logo). AlterWear couples energy harvested from an NFC-enabled device with e-ink displays to afford dynamic interactions and expressions without the need for on-board power.

demonstrates the framework’s ability to tease out differences in affordances of form factors, even those with similar (if not identical) functionality.

Each AlterWear device has a visible e-ink display. This display may be discreet and only noticeable to the user themselves, or it may be outward-facing and public. In either case, this display is powered and updated when it comes in contact with near-field communication (NFC). This increasingly ubiquitous wireless power source is commonly found in mobile phones, IoT devices, and public infrastructure. AlterWear leverages this synergistic infrastructure to opportunistically power and update e-ink displays. The bistable nature of these displays allows designs to persist for long periods of time without additional power or maintenance. Persistent contact with NFC also allows for animated dynamic displays. I argue that the presented architecture can enable a diverse range of new wearable devices and can enable intentionally performative and playful interactions. While not inherently cosmetic in nature, I believe that AlterWear can inspire and inform the creation of *cosmetic computing* form factors.

System Architecture

Design Constraints

Engaging motivations around limited power and novel lightweight interaction styles, the implementation of AlterWear was driven by several design constraints: (1) unpowered visual display, (2) lightweight quick interactions, (3) dynamic updates, and (4) adaptable across a wide range of wearable form factors. These constraints led to the physical design detailed below.

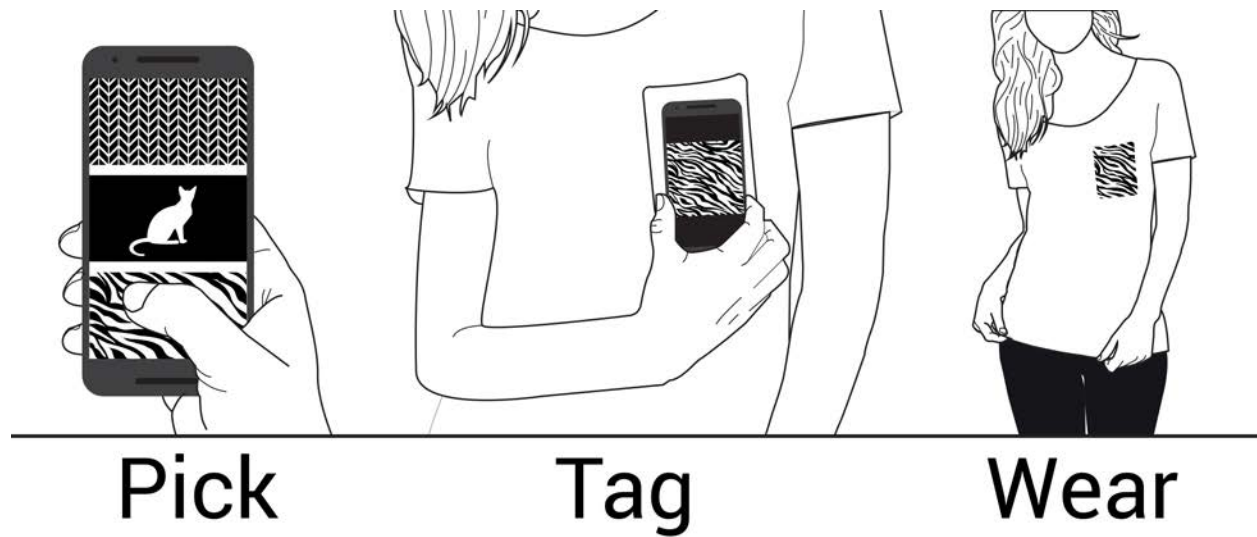

Figure 6.4: Interaction model for AlterWear displays. Users 1) pick a design using their Smartphone or other NFC-enabled device, 2) tag the device to their display to update it, and then 3) wear their new design without the need to recharge it, update it, or maintain it.

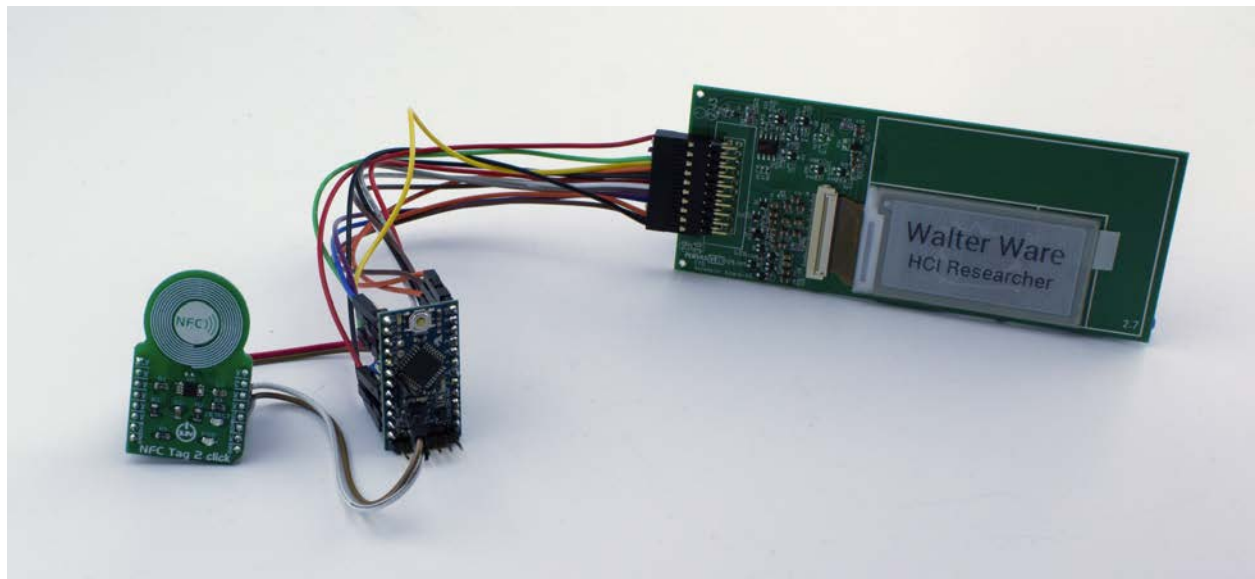

Figure 6.5: The larger prototypes use an NFC Tag 2 Click breakout board, an Arduino Pro Mini microcontroller, and an e-ink display with EPD Extension Kit. While these components are relatively large and bulky, the size can be significantly reduced with custom hardware (see Figure 4.6).

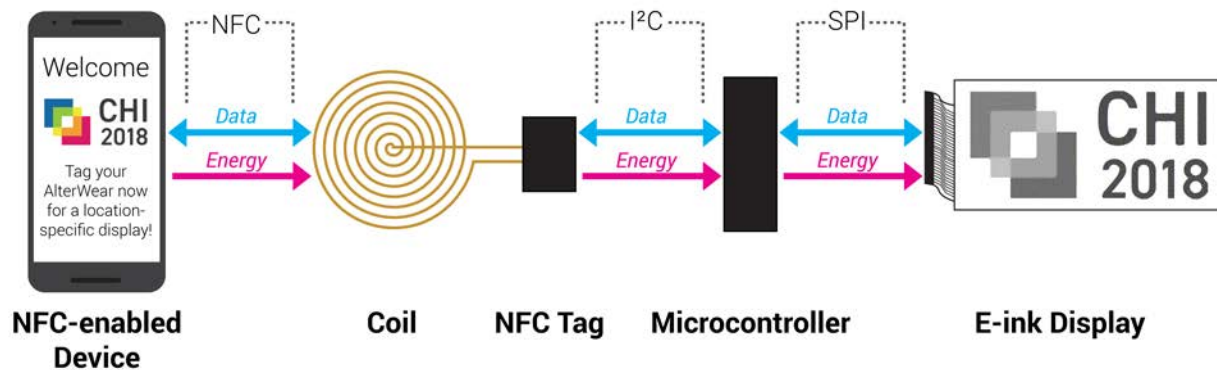

Figure 6.6: The AlterWear architecture includes an NFC tag, a microcontroller, and an e-ink display that are powered and updated through contact with an NFC-enabled device. When the device comes into contact with AlterWear, energy and data are transferred via NFC. The NFC tag then powers and transfers data via I²C to the connected microcontroller. Finally, the microcontroller powers and communicates with the e-ink display over SPI.

Hardware Architecture

The system contains a microcontroller, an NFC tag, an e-ink display, and a printed inductive coil. The coil provides the mechanism to wirelessly transmit power and data to and from the AlterWear platform (see Figure 6.6). AlterWear uses commodity NFC hardware to establish wireless communication between close ($\leq 15\text{mm}$) devices, to briefly power and exchange data. The e-ink provides a bistable display that has the desirable property of maintaining visual state even when it is unpowered. Updating e-ink displays is an extremely low power operation. At peak power, the entire system consumes 6mA at 2.7V (See Table 6.1). AlterWear uses NT3H1101 NFC Tags, Arduino Pro Mini microcontrollers, and e-ink displays from Pervasive Displays (Figure 6.5); however, these components could be swapped with equivalent components. The larger prototypes utilize standard Arduino firmware and readily available libraries for updating e-ink displays and communicating via I²C.

When the system comes into contact with an object with embedded NFC, power and data is transferred from that object to the wearable display (A 4-byte write operation over NFC occurs in $< 4.8\text{ ms}$ to EEPROM and $> 0.8\text{ ms}$ to SRAM). This could be identification information, sensor data, a bitmap to be displayed, or a number of other data structures. Once this information has been transmitted, the e-ink display updates. This display is maintained even after the user has disengaged with the inductive field created by NFC. If the user sustains contact between the NFC-enabled device and their AlterWear display, the display will begin to animate. This interaction can easily be facilitated by designing AlterWear on pockets, phone cases, and other areas that are frequently in contact with the user's NFC-enabled phone.

Peak Power Requirements		
Current	Voltage	Time
6mA	2.7V	2.4 sec

Table 6.1: The e-ink display needs to maintain power during the update only. On an Atmel 328p chip, the time required to update the display is 2.4 seconds. The amount of energy that can be harvested varies based on a variety of factors. Voltage and current may change based on the strength of the RF field, the size of the tag antenna, and the distance between the NFC device and the coil.

While future iterations could leverage recent research in wireless charging [23] to update AlterWear at a distance, the current interaction involves touching the phone to the wearable display in order to power and update it (See Figure 6.4). Alternatively, displays could update in response to NFC from IoT devices and other sources.

Range of NFC: The range of NFC is greatly impacted by the size of the antenna, as well as the number of turns. The custom hardware (Figure 4.6) has a coil size of 17mm x 12mm with 6 turns, and has a range of 1mm. The Tag 2 Click NFC tag used in the larger prototypes (Figure 6.5) has a coil size of 20mmx20mm, 8 turns, and a range of 15mm.

Design Considerations

Wearables demand attention to not only the functionality of the device but its ability to participate in an individual’s personal fashion and visual aesthetic (*aesthetics*). As such, a significant consideration in the overall design is the ease and flexibility of personalization and customization of AlterWear devices (*customizability*).

- **Form Factor:** Wearable form factors vary in their size, shape, and location on the body (*physicality*). Due to these differences, many applications are better suited for one garment or accessory over another. The user’s personal style should also be taken into account.
- **Location of E-ink Display:** As form factors vary in visibility, so do locations on form factors (*aesthetics*). The location of the e-ink display on a garment or accessory should be informed by existing cultural practices and affordances of the object (*social & cultural considerations*). For example, the location of tee shirt displays should be informed by existing tee shirt designs. Jewelry form factors should similarly be informed by existing jewelry.
- **Type of E-ink Display:** E-ink displays vary widely in size. The largest size supported by AlterWear’s implementation is 1.9”. Colored e-ink displays may be more widely available in the near future, although they will likely have different power requirements.

- **Location of Coil:** The location of the coil may convey information about who should interact with it. Proximity to the e-ink display makes a more obvious interaction, while distance can provide a more subtle one. Additionally, coil placement influences the available modes of interaction (*interaction modalities*).

Modes of Interaction

The design considerations previously outlined lend themselves to five distinct modes of interaction: direct tagging, disjointed tagging, animated displays, obscured updates, and situated updates.

- **Direct Tagging:** For direct tagging, the e-ink display and inductive coil are co-located; the user tags the display directly in order to update it (see Figure 6.4). This mode of interaction is intuitive and therefore well suited to social interactions.
- **Disjointed Tagging:** For disjointed tagging, the e-ink display and inductive coil are isolated in separate locations; the user tags one location of the body to update a display on another (see Figure 6.10). This mode of interaction is discreet and well suited for more personal displays; onlookers do not immediately know where and how to interact with the display. Disjointed tagging is also useful for displays in hard-to-reach locations (*physicality*). For instance, instead of straining to reach a display on the back of a jacket, the coil could be located in a more accessible location, such as the front or the sleeve. Finally, disjointed tagging allows for more subtle interactions. Rather than conspicuously tagging a display and consequently calling attention to it, an isolated coil provides for more discreet interactions.
- **Animated Displays:** If the coil is near a reliable power source, the display can cycle through a series of images to create an animation. Depending on the choice of images, the animation may be subtle, or eye-catching (*aesthetics*). Designers of AlterWear can enable animated displays by situating the inductive coil in locations that are frequently in contact with NFC (see Figure 6.7). These locations include places that the user normally keeps their NFC-enabled Smartphone, such as the inside of a pocket or a bag (*usage patterns*). The display will animate as long as the coil remains in contact with the NFC-enabled device.
- **Obscured Updates:** NFC is able to transmit both power and data through fabric and other thin materials (less than 15mm). Designers and users can leverage this property to enable obscured updates. Without taking out their NFC-enabled Smartphone, users can simply tag their AlterWear to the phone through a bag, backpack, or pocket. This mode of interaction is best suited to form factors that are more maneuverable, such as bracelets, watches, shoes (Figure 6.9), and false fingernails (Figure 4.6).
- **Situated Updates:** While the previous modes of interaction utilize NFC-enabled Smartphones, IoT devices and public infrastructure can similarly update AlterWear



Figure 6.7: Pocket tee prototype. Left: name tag application. Right: when the user places their NFC-enabled phone in their pocket, the phone continuously powers the display, and a simple animation is displayed.

devices (see Figure 6.10). Similar to obscured updates, this mode of interaction is best suited to form factors that are more maneuverable, or form factors that are often removed (*removability*), such as gloves, jackets, bags, and hats (Figure 6.8).

Exemplar Prototypes

Six initial prototypes were designed and implemented to demonstrate the AlterWear architecture and resulting battery-free wearable displays.

Pocket Tee

The shirt prototype (see Figure 6.7) is a modified pocket tee. The existing pocket is augmented with a 2.0" e-ink display and embedded the NFC coil directly below. The location of this coil supports two modes of interaction; it's proximity to the e-ink display enables direct tagging, whereas its location in a pocket affords animated displays. If a phone is carried in the pocket, the display can be continuously powered and animated. The microcontroller and other components are discreetly sewn into the pocket. This form factor was chosen because tee shirts are culturally accepted as a form of expression, and it is fairly common to see logos, designs, text, and other visual cues across the chest (*social & cultural considerations*). Furthermore, the pocket provides a natural substrate for small embedded displays (*physicality*).

Imagine Walter Ware is heading to a job fair. He realizes it would be nice to have a name tag for the event, and quickly updates his shirt with his name, title,



Figure 6.8: Baseball hat prototypes. Left: Hat prototype with AlterWear display on the front panel. Right: Hat prototype with AlterWear display on the side panel. Below: Close up of the side design. This prototype includes a simple animation when updating the display to give the appearance of sparkling or twinkling stars.

and a little drawing he did of his personal logo. After he arrives at the event, he decides the drawing feels unprofessional, so he quickly updates the display to remove it. He notices his favorite company is there, and knows they're looking for a UX designer in particular, so he updates his job title to UX designer before approaching their table.

Baseball Hat

Two hat prototypes were designed and prototyped (see Figure 6.8). These prototypes are standard baseball hats that have been augmented with AlterWear. This form factor was chosen because hats are frequently used to express interests and contextual cues, such as sporting teams and events (*social & cultural considerations*). Hats are also easily removed (*removability*) and therefore ideal candidates for situated updates (see Figure 6.10). Each of the hat prototypes has an e-ink display embedded in the crown of the hat (in either the front panel, or a side panel), and an NFC coil hidden in the back. The separation of coil and display supports disjointed tagging. This discreet form of input is desirable over direct tagging, as the user cannot see the display that they are wearing, and likely do not want



Figure 6.9: Sneaker prototype. Left: Discreet display on the inside heel of the left shoe. Right: Public display on the toe of the right shoe. AlterWear devices are highly contextual. A single artifact can be both personal and public depending on the location of the display.

others to know how to update it. Additionally, the back of the hat is more likely to come in contact with external surfaces and objects when not being worn, further enabling situated updates. The microcontroller and other components are discreetly sewn into the hat.

For the first hat prototype, an e-ink display was added to the front panel of the hat. This is ideal for showcasing logos or designs. This design leverages a 1.9” e-ink display: the display is large enough to be visible, yet not so large that it compromises the appearance or feel of the hat itself. For the second hat prototype, 3 star-shaped openings were laser-cut into the side panel of the hat, and a 1.44” e-ink display was attached directly behind. The e-ink is programmed to make the pattern stand out or fade into the background, as desired. This display is more subtle and demonstrates how AlterWear can be more abstract.

Walter and his family love to attend sporting events, but they each prefer a different sport. Last week, Walter and his daughter enjoyed a hockey game. Today Walter is going to a football game with his son. As they walk into the stadium, Walter presses the back of his favorite baseball hat to the particular section of the turnstile, and the display updates from the logo of the hockey team to show the logo for the home team. This weekend, Walter will update the display to show a custom design he made in support of his daughter’s softball team. He is relieved he doesn’t need to own more than one baseball hat, but can still easily update the display so it’s appropriate to the changing context.

Sneaker

A pair of sneakers were also augmented with AlterWear technology (see Figure 6.9). On one shoe, the logo was replaced with an 1.9” e-ink display. On the other shoe, a 1.44”

e-ink display was embedded in the vamp. Both locations are rigid and therefore ideal for introducing electronics (*physicality*). In both shoes, the coil is adjacent to the visual display. While the close proximity of display and coil allows for direct tagging, the shoe form factor enables obscured updates. Rather than taking their Smartphone out of their backpack or bag, the user can discreetly check for updates by moving their shoe next to their concealed phone. These updates are then glance-able in their respective locations.

- **Sneaker Logo:** The distinctive logo of this brand of sneakers provides an obvious location for personalized display. The slightly hidden location on the inside of the ankle is a good fit for functional or private designs. As the logo is already a busy part of the shoe, added designs at this location are discreet.
- **Sneaker Vamp:** On the other hand² the vamp is a popular location for sneaker adornment, such as Sharpie inscriptions and other doodles (*social & cultural considerations*). The existing cultural practices around drawing on the vamp, and the rigidity (*physicality*) provide a culturally relevant and structurally sound site for augmentation. The display here references this existing practice of decoration for a more social, purposefully performative display.

Walter is meeting his daughter Sal for lunch. He arrives early, so he sits down, crosses his ankle over his knee, and tags his logo display to check his current step count (See Figure 6.13). He's grateful for the information, but happy that he doesn't need to open an app to see it, and glad that the display will subtly blend with the design of the shoe. When Sal arrives, she tags the vamp of her own sneaker and an 8-bit heart she's designed appears (See Figure 6.9). The next morning, Walter sees the 8-bit heart again and it reminds him of the lovely conversation they shared the day before.

False Fingernail

The final prototype is a false fingernail form factor (see Figure 4.6) based on previous work on fingernail-worn devices (See Chapter 4). This wearable was fabricated to demonstrate that AlterWear hardware can be implemented at a very small scale and can be applied to cosmetic form factors. Directly underneath the e-ink display, the location of the inductive coil supports direct tagging. Additionally, the fingernail form factor enables both obscured and situated updates.

Walter is anxious to know if his important package has been delivered; however, it is only his third day as a UX designer and he doesn't want to be seen on his personal phone at work. While glancing over some new designs, Walter rests his hand on his thigh, subtly tagging his nail to the phone in his pocket. When he

²foot

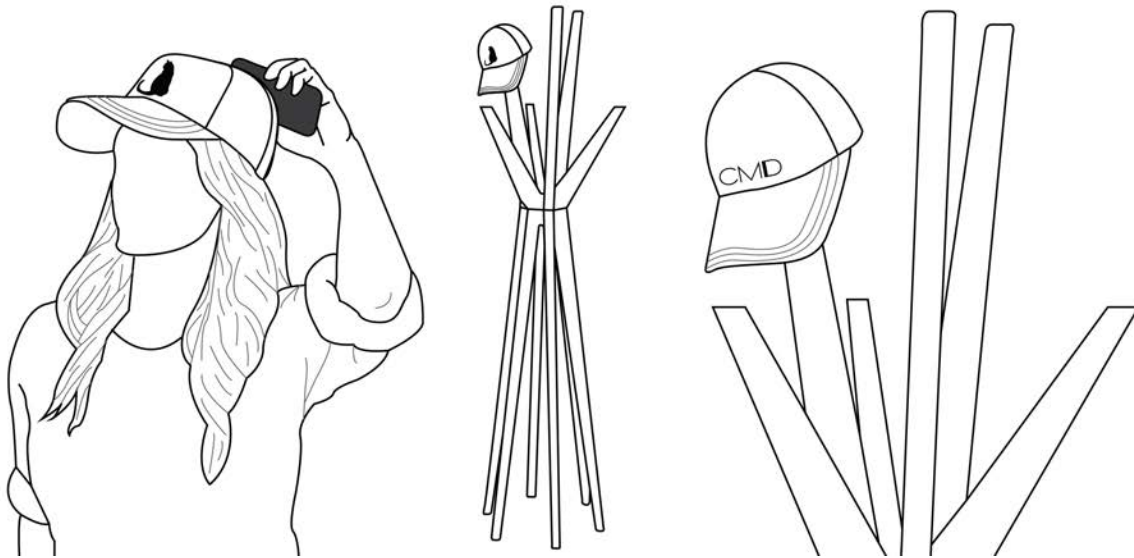

Figure 6.10: Disjointed tagging (left) and situated updates (right). Camila is volunteering at her local animal shelter. She tags her phone to the back of her hat to update the display on the front. It now showcases the shelter’s logo. When she returns home, she hangs her hat on an NFC-enabled hat rack, which updates the hat to her default design: her initials.

picks up his pen to annotate the designs, he briefly glances at the display to see that a new dot has emerged: his package is safe at home. Walter feels relieved and re-energized as he continues his work.

Applications

As with many wearables, the form factor, location on body, and type of display are all important considerations when determining the class of applications. I present here a selection of proposed use cases for AlterWear.

Notifications

In contrast with the notifications of many existing wearables, which vibrate, flash, or otherwise do their best to command attention, AlterWear updates only when desired. This makes AlterWear ideal for pull notifications. Rather than unlocking their phone and opening an app, users can simply tag the phone to their AlterWear to view relevant information and updates. Examples include viewing health or fitness data, checking non-urgent logs from a sensor, and confirming if the details of an event have updated. AlterWear provides notifications at the moment the user needs them, rather than the moment they become available. Notifications can also be discreet. Users can utilize obscured updates to check for notifi-

cations: simply tag AlterWear to their phone through a backpack, pocket, or other thin material, and view the updated information at an appropriate time. Personal information can be displayed in discreet locations (see Figure 6.13).

Personal Expression

AlterWear can be used for personal expression and as a public-facing display. AlterWear displays are public displays in the same sense that wearing a logo, a graphic t-shirt, or a hat is a public display; however, the prototypes render these displays dynamically, allowing the user to update them quickly, discreetly, and at any time (*mutability*). A small display embedded into an article of clothing or an accessory renders the entire piece dynamic, and can provide a small but playful site for creativity.

Social Engagement

AlterWear fosters social connection. The act of tagging a display on another person and sharing your design with them can promote intimacy and connection. The data shared can be intimate, such as how NFC is currently used to share photos, videos, and contact information, but the *nature* of the interaction is also intimate. The act of tagging a friend to update their display may further enhance the sense of closeness, as it brings an element of mediated social touch into the interaction [58]. Due to the intimate nature of touch, users may only want to share/exchange displays with close friends, but this would enhance their sense of social connection. A user can share a design by updating their friend's AlterWear directly through tagging, or by sending them the designs to tag themselves.

Location-Based Interactions

Rather than being selected explicitly by the user, designs could be tied to particular locations or events. For example, everyone at a corporate party, a basketball game, or other large event could access a design unique to that event. Users could display the design while at the event, which could also act as a digital memento that they can keep and display.

Discussion and Future Work

Two-way communication

Currently, AlterWear uses NFC to read information from the NFC-enabled device; however, the communication protocol works in both directions. Future iterations of AlterWear could utilize this back-channel to communicate and send data back to the NFC-enabled device. This would enable interactions where an NFC-enabled phone could “read” an AlterWear device, and copy the design to additional AlterWear devices. Sensors could also be embedded into AlterWear to provide data to inquiring NFC-enabled devices. However, these embedded



Figure 6.11: To demonstrate durability and longevity of AlterWear devices, the fingernail prototype was completely enclosed in resin. The prototype is durable, waterproof, and still entirely functional.

sensors must be small and low-power. Reasonable sensors include accelerometers, photodiodes, temperature sensors, and the like.

E-ink displays

The e-ink displays used in the prototypes are all rigid, rectilinear, and monochrome (see Figure 6.12); however, e-ink displays are becoming increasingly available in commercial markets. These e-ink displays are available in custom non-linear shapes, flexible form factors, and a limited range of colors. Further customization can be achieved by personally fabricating custom displays [177] and exploring other materials, such as electroluminescence.

Power considerations

As mentioned previously, future iterations of AlterWear could leverage corporate research into wireless power [23]. Additionally, AlterWear could be augmented with capacitors to store charge for on-demand interactions.

Durability

Since the electronics of AlterWear never need to be accessible for charging or programming, AlterWear can be completely encapsulated in waterproof enclosures. To demonstrate this, the fingernail prototype, as well as an NFC Tag 2 Click breakout board were completely enclosed in clear resin (see Figure 6.11). Both devices were fully immersed in water, and the Tag 2 Click was left submerged for a period of three days. Both devices remain intact and fully functional. Thus, AlterWear can be rendered robust and sturdy, and could endure many trips through the washing machine, adventures through inclement weather, changes in trends, hand-me-downs through siblings and friends, eventual abandonment at a donation site or thrift shop, and new life through repurchase. These artifacts could take on a life of their own through multiple owners, and through various interactions and uses.

Advantages over existing wearables

In addition to their aforementioned durability and longevity, AlterWear provides several other advantages over existing wearable devices. Rather than the “one size fits all” mentality prevalent in current wearable technologies, AlterWear provides an array of diverse form factors and interactions that are driven by context. AlterWear also responds to the “one device to rule them all” way of thinking by intentionally limiting interaction. This limited functionality is paralleled by limited responsibility for the user to charge, care for, and even think about their devices. AlterWear’s restructuring of notifications to be user-driven, rather than device-driven, has an advantage in that users don’t have to dedicate cognitive load to thinking about their devices and anticipating notifications [173]. Finally, AlterWear enables intentionally performative and playful interactions that were previously infeasible with existing wearable technologies.

6.4 User Study

I will now present results from a user study conducted to probe perceptions of wearable battery-free displays, and to evaluate designed AlterWear prototypes.

Participants

Thirteen participants provided feedback on the AlterWear prototypes (7 female, Average age 23.6). Participants self-rated their experience with wearables. 11 stated that they own “one or more” wearable devices and rated themselves as “using it frequently”. The other participants used a wearable device “often” or “occasionally”, or used to own one.

Participants were recruited from University and local mailing lists and were invited to a studio location for an hour-long workshop. They were compensated at the rate of \$20/hour. After filling out a survey regarding background experience with wearables, participants were invited to interact with the designed AlterWear prototypes. The study concluded with an



Figure 6.12: The designed AlterWear prototypes. These prototypes vary in size, form factor, and location on the body. Several of these prototypes are more suited to public applications and displays, whereas others are more subtle and personal.

informal interview, a brainstorming activity, and assessment questionnaires. All interview meetings were audio recorded, transcribed, and analyzed, following best practices for a qualitative interview [208].

Qualitative Findings

Social and Individual Uses Both Desired

All users appreciated the potential for social games or interactions enabled by the devices. In particular, participants were drawn to the idea of location-specific geo-filter type interactions. Three users specifically expressed interest in creating a cohesive social experience at a party

or other event. Participants universally felt that a personalized display would lower barriers to social interactions and foster connection.

The display could give you some details, some kind of funny information about the person and then you could start from there...It could make the conversation less superficial, and less official, and more intimate and more social (P7).

While users expressed interest in the displays helping to ease social interaction, six users (five male) expressed a rapid and comedic sense of extreme horror at the idea of their friends having the ability to update their display. These users immediately felt that the display would be used to share inappropriate material, and laughingly insisted that they wouldn't trust their friends.

Oh no no no no way, no, I would not let my friends have access (P10).

Hahaha definitely not, that would be way too risky (P1).

I would not be interested in that at all (P13).

Generally, participants wanted control over what designs appeared on their clothing. No user expressed interest in autonomously generated patterns or displays, or automatically updating displays with a design they didn't choose. About half of the participants were drawn to discreet, personal, and functional displays, whereas the others were more intrigued by outward-facing, public displays for fashion.

Customizable Fashion is Appealing as “Extension of Self”

Universally, users recognized that their fashion choices were highly contextual, and responded very positively to the idea of a display that could be easily updated.

If it's a thing that can be changed, then I definitely want it to be changed (P2).

However, users weren't sure that the changes in the prototype displays were always significant enough to register as a 'different style'.

Ten users preferred the animated displays to the static ones. They commented that a moving display on your person would be unique and eye-catching, unlike anything they had seen before. As the prototypes are all wearable and closely approximate familiar form factors, such as clothing and accessories, participants tended to view them as “extension of self”: intimately intertwined with their sense of personal identity, and influencing the way in which others perceive them.

One user was an artist, and expressed interest in using the display to test out her graphic designs. She imagined updating a design throughout the day, and seeing what kinds of reactions she might get.

Novel Functionalities Justify Additional Wearables

The notion that wearables are meant to be functional, and to track, notify, or otherwise inform was strong with 10 of the users. Three users thought that tracking or sensor data of some kind was part of the definition of a wearable device. A device that was designed to help express *style* was a novel idea to these users. About half of these participants were not interested in using AlterWear for fashion and were instead more intrigued by functional applications and instances.

While envisioned future work for AlterWear originally included a communication protocol between devices, most of the users were very opposed to this idea, and envisioned having just one AlterWear device. The exception was multiple devices with unique functions, in which case the need for more than one device was more clear.

Preferred On-Body Location Highly Variable

Participants varied widely in where they felt would be an appropriate location for AlterWear. Customization is clearly especially important in wearable devices, where the form factor and location is influenced not only by function, but by the user's sense of aesthetics and notions of presentation of self. One user thought the sleeve would be ideal, and another thought a sleeve-based display would be strange. Another user was adamantly opposed to any kind of display on pants, and described a display on a skirt or a dress as "awfully weird". It's impossible to anticipate all of the fashion choices people would desire, but a flexible, customizable design can support a range of aesthetic choices.

Pull Notifications Viewed as Less Intrusive

Ten of the thirteen participants vehemently complained about receiving notifications on their wearables or other devices. Many commented that they immediately turn off all notifications going to their wearable devices, and see no added benefit to getting the notification on the wearable interface. In particular, they resented the intrusiveness of beeps, buzzes, or alarms:

With the current way wearables are working, they're adding more distractions to your life rather than getting rid of distractions (P8).

Five users with high levels of experience using wearables conceptualized devices as needing care and support from their owners:

I'd worry about having a lot of devices that all want something from you (P1).

Users frequently personified existing wearables, describing them as "too many dead items trying to simulate life" (P7), or in agentic terms.

It's not like dystopic - too scary. It's more like too annoying. Oh, now the hat wants to tell me something, or now the box wants to (P7).

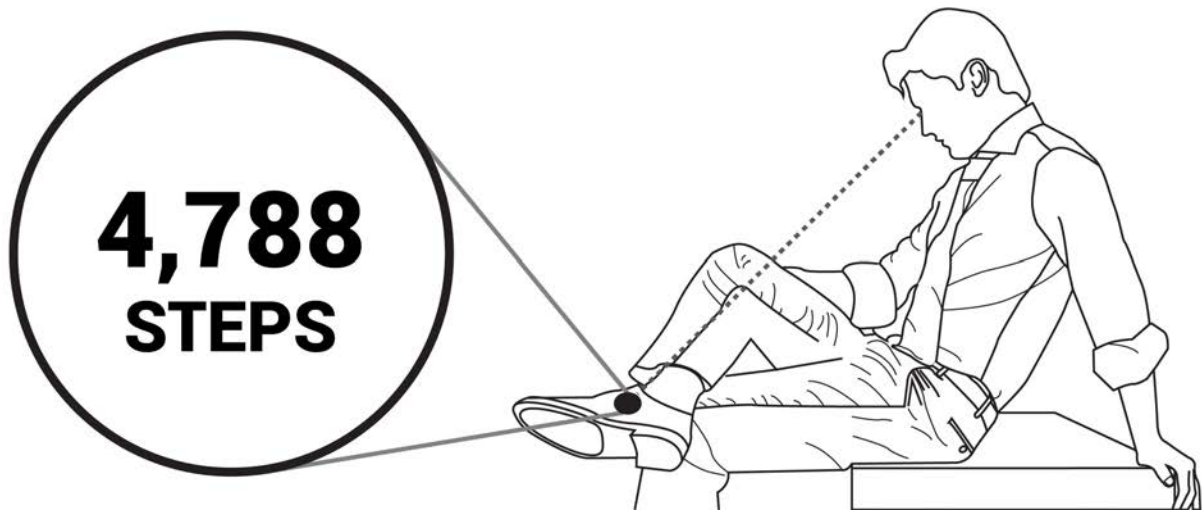

Figure 6.13: Example application of a discreet display. The user checks fitness information displayed discreetly on the inside of his heel.

In contrast, a less interactive system was more appealing.

Anything that requires less input from me, that means lesser engagement with the gadget from my side, I'd always prefer that (P6).

Battery-less Interfaces Perceived as Less Demanding

Five users specifically identified the frustration involved in maintaining batteries as a reason for not wanting to use a new wearable device.

It's annoying that you have to charge another extra device (P12).

I wish you didn't have to recharge them as often (P9).

These users commented positively on the battery-less nature of AlterWear:

I do like that you can just use your phone to power it so you don't have to charge it or anything, and carry a charger around with it (P5).

A few of the other users likely didn't fully absorb the fact that AlterWear requires no battery, even though it was stated several times. For future work, I envision a more extensive user study where participants actually take home the AlterWear devices for an extended period of time, and fully experience their longevity in the absence of charging.

Integrated Form Factor Supports Adoption

Participants positively responded to the more seamlessly integrated form factors, such as the shoe. One user particularly responded to this form factor.

It's not something I would have to wear on top of something else, like you have to wear your shoes (P4).

The more seamlessly the e-ink displays were integrated into the prototypes, the stronger and more positively participants reacted. A number of users were attracted to the simple and neutral paper-like appearance of the e-ink display, which they preferred over other types of displays that emit light.

From afar, it kinda looks neutral. It looks like a regular shirt (P1).

A minority of users viewed the e-ink displays as distinct and separate from the garments. These users did not like the screen-like aesthetic: “I don’t like the square” (P4); “Most of these seem to be hidden behind a window” (P1).

Physicality of Interaction Affords Intimacy

Participants were intrigued by the social interactions afforded by the AlterWear prototypes. They wanted to share designs with their friends, and specifically identified the physical “tag” gesture as supporting a sense of intimacy and closeness. Four participants saw the touch interaction as specifically important to the intimate experience.

it would be a good way to connect with people. If you could touch the [phone and their clothing] together and have a bond (P1).

Half of the participants felt that the required physical interaction naturally resolved issues of privacy and consent: if you’re close enough friends to physically touch, then you’re close enough to update each other’s designs.

If you have to touch them to transfer the design, that [is] totally different. You do it in front of their face so you have their permission to do it (P3).

Participants also thought the act of tagging helped maintain their control over what appeared on their clothing.

I would want the option to show up, and I could change it to that, but not automatically changing it without me actually [tagging] it (P5).

One user thought the tagging gesture was too much of a barrier to using the displays, but the majority of users thought the interaction was either good, or a worthwhile trade-off in exchange for not having to maintain a battery. One user actually preferred the tagging gesture and perceived the functionality of the device more clearly because of it.

I would want to keep the [tagging], rather than just clicking [a button]...so I don't have to check that it updated, because I know it did (P5).

Synthesis

Here I briefly synthesize findings from the user study. In terms of form factor, participants highly rated well-integrated form factors, viewed on-body wearables as an extension of their own identity, and expressed interest in a variety of personal and social functions. For the interaction style, participants positively responded to the idea of a battery-less device, a physical gesture to update display, and only pull notifications. Designers of wearable interfaces should consider how much effort is involved in maintaining on-body devices, and mentally managing notifications.

6.5 Discussion

Extracting *mutability* and *sociality* from the presented framework as parameters, we can plot existing body-worn artifacts within the design space (See Figure 6.14). For this characterization, I leverage Dagan et al.'s definition of sociality: “encouraging and promoting co-located social interaction to facilitate prosocial behavior” [34]. In this regard, fingernails, makeup, clothing, accessories, and hair are all moderately social. While part of the body and inherently personal, these body-worn artifacts can invite social interaction: it is common for someone to have their hair, makeup, or fingernails “done” (styled, applied, and painted, respectively) by friends, family, or professionals; clothing and accessories are borrowed and exchanged; shoelaces are tied, jewelry is clasped, and zippers are zipped by non-wearers. AlterWear expands the *sociality* of clothing and accessories. In addition to being borrowed, exchanged, and fastened by others, AlterWear artifacts can be “tagged”, inviting further social engagement. In addition, AlterWear expands the *mutability* of clothing and accessories. Rather than being styled once per day and adjusted occasionally throughout, AlterWear allows garments and accessories to be constantly updated.

We can also evaluate AlterWear's enabled modes of interaction through the lens of the framework (See Figure 6.15). Animated Displays can be conscious or unconscious (e.g., the coil is located where the wearer naturally stores their phone), but are always performative. Similarly, Situated Updates can be conscious or unconscious. Direct Tagging, Disjointed Tagging, and Obscured Updates are always conscious, but vary in terms of *performativity*. The *performativity* of Direct and Disjointed Tagging are dependent on the body location of the coil, as well as the interaction context. Direct Tagging is typically more performative

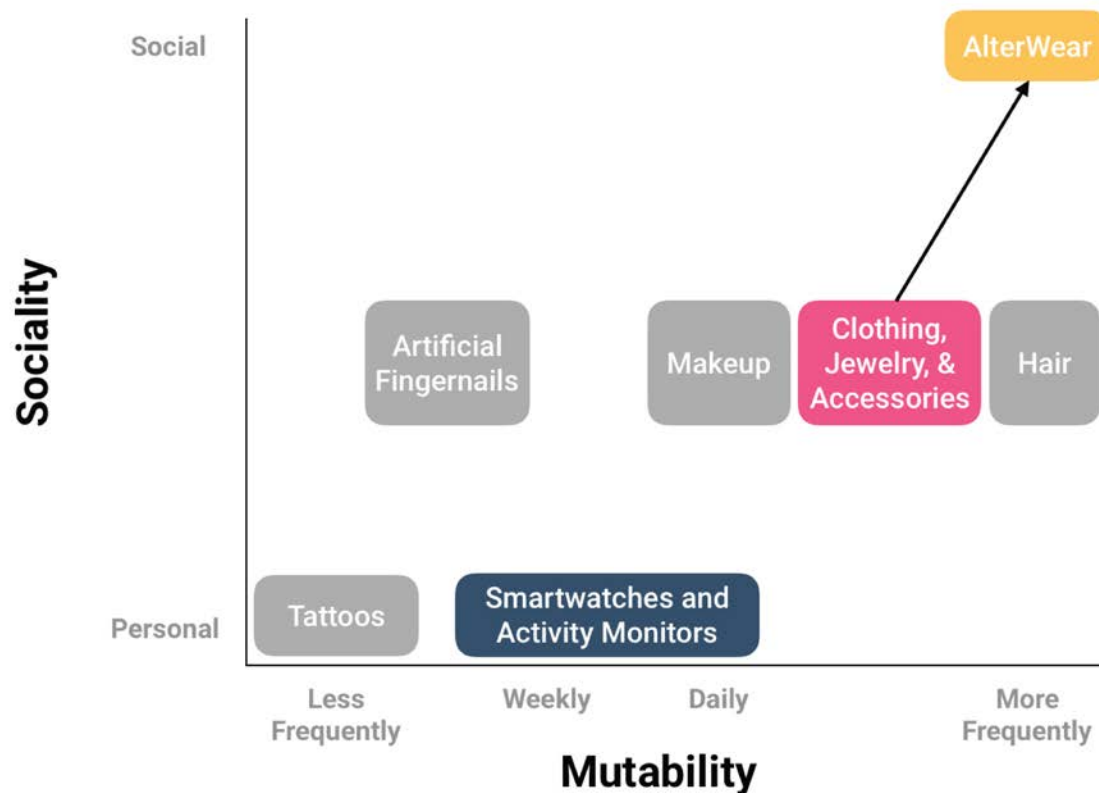

Figure 6.14: Sociality and Mutability of various body-worn artifacts. AlterWear (shown in yellow) expands both the sociality and mutability of traditional clothing and accessories (shown in pink). Commercially prevalent wearable technologies are shown in dark blue.

than Disjointed Tagging, since the movements of the wearer call attention to the display (co-located with the coil). Obscured Updates are inconspicuous by nature.

6.6 Summary

This chapter highlighted *maintenance* as a compelling characteristic of body-worn artifacts, and described the design and implementation of low-maintenance wearable technology — AlterWear. AlterWear combines NFC and e-ink displays to enable lightweight interactions with dynamic clothing and accessories.

I highlighted key design considerations for AlterWear artifacts related to *physicality* (form factor), *aesthetics* (location & type of e-ink display), *interaction modalities* (location of coil), *social & cultural considerations*, and *customizability*. Leveraging these design considerations, I identified five distinct modes of interaction enabled through AlterWear: direct tagging,

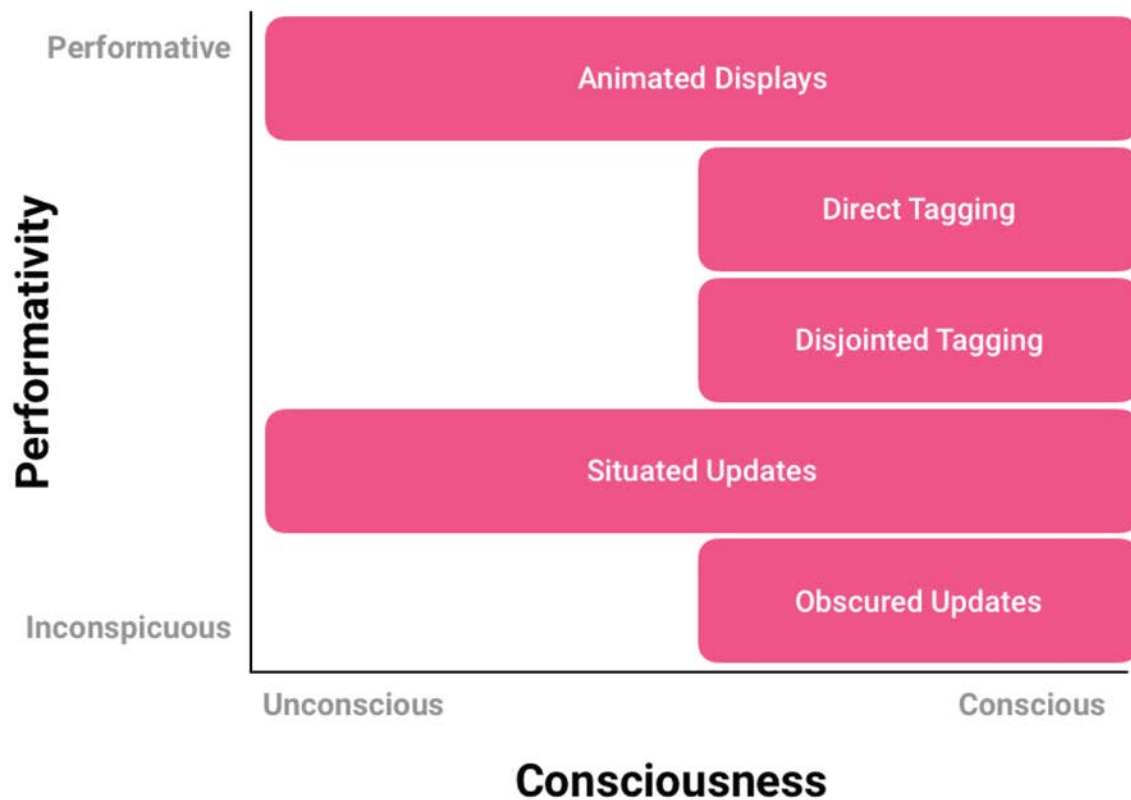

Figure 6.15: Performativity and Consciousness of AlterWear interaction modalities.

disjointed tagging, animated displays, obscured updates, and situated updates. Embodying the design considerations and modes of interaction, I discussed the design and fabrication of six AlterWear prototypes: a pocket tee, two hat prototypes, two sneaker prototypes, and an artificial fingernail form factor. These prototypes demonstrate how a particular functionality (low-maintenance dynamic displays) can be embedded in body-worn artifacts with varying *visibility* and *accessibility* (reachability) (See Figure 6.2), among other differences.

I presented a user study conducted to evaluate the designed prototypes and to probe perceptions of low-maintenance dynamic wearable displays more generally. In addition to introducing participants to the AlterWear prototypes, the study included an informal interview, a brainstorming activity, and assessment questionnaires. Participants responded positively to the high *mutability* and low *maintenance* requirements of AlterWear prototypes. Participants also appreciated the *physicality* of the “tagging” gesture for updating the displays, identifying the *sociality* of this interaction modality. Participants desired both social and individual use cases, and identified the need for *customizability* to support a broad range of personal aesthetics. I argued that AlterWear expands both the *sociality* and *mutability* of traditional clothing and accessories (See Figure 6.14), and discussed the *performativity* and

consciousness of the enabled modes of interaction (See Figure 6.15).

The work presented in this chapter showcases the framework’s ability to tease out differences among form factors, demonstrating how a particular functionality (low-maintenance dynamic displays) can be embodied in a variety of body-worn artifacts with varying affordances. The next chapter takes a similar approach, but with a specific focus on a single form factor that is highly contextual —hats. I leverage the framework to surface differences between hat form factors in terms of physical form, inherent functions, and contexts of use.

Chapter 7

Interactive Hats

Another compelling characteristic of body-worn artifacts is their associated contexts of use. Organized within the framework under *usage patterns*, contexts of use include sports & fitness, health & safety, lifestyle & fashion, and social signaling of group identity, among many others. In this chapter, I focus on a single form factor that is highly contextual—hats.

Figure 7.1 is a two dimensional projection of body location and *contexts of use* for various body-worn artifacts. The highlighted contexts of use were adapted from the identified application categories for wearable devices in [11], as well as the defined categories from [78]. Security/Prevention is excluded, as this was the least common product type, as well as Gaming/Novelty, as this category scales less readily to traditional body-worn artifacts without added technology. “Social Signaling of Group Identity” was added to further contextualize the role of body-worn artifacts. As all visible wearable artifacts participate in social signaling, this category explicitly refers to social signaling of group identity.

While hats are diverse in many aspects including *physical form*, *social acceptability*, and *inherent functions*, this head-worn form factor is particularly compelling in terms of associated *contexts*. A particular hat can have multiple contexts of use (e.g., sun hats both protect from the sun and participate in personal fashion), or a single, more prescribed use (e.g., hard hats are exclusively used for personal safety). This diversity in *contexts of use* make hats a compelling site for technological inquiry.

In this chapter, I leverage the framework to inform *Heirloom* hat-worn technology¹. I identify design considerations for interactive hats, and conduct a gesture elicitation study to inform appropriate interaction modalities. I present three hat prototypes to illustrate how *Heirloom Wearables* are impacted by *physical form*, *inherent functions*, and *contexts of use*. The chapter concludes with an evaluation of the designed technology.

¹Elements of this chapter were previously published in: Christine Dierk, Scott Carter, Patrick Chiu, Tony Dunnigan, and Don Kimber. 2019. Use Your Head! Exploring Interaction Modalities for Hat Technologies. In Proceedings of the 2019 on Designing Interactive Systems Conference (DIS '19). Association for Computing Machinery, New York, NY, USA, 1033–1045. DOI:<https://doi.org/10.1145/3322276.3322356>

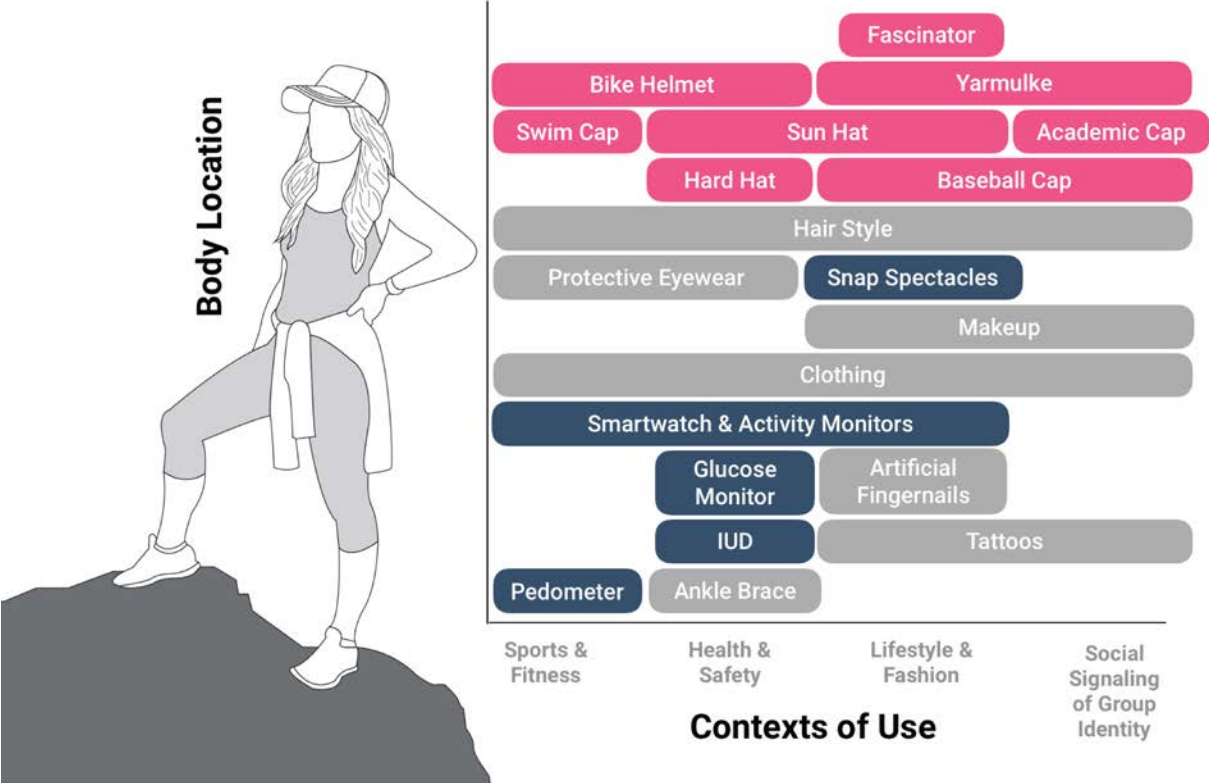

Figure 7.1: Body Location and Contexts of Use for various body-worn artifacts. The diversity of hats contributes to a broad range of contexts of use. Existing wearable technologies are shown in dark blue; hat form factors are shown in pink. Figure is illustrative only, body locations are approximate.

7.1 Introduction

An increasing number of wearable devices are situated on our heads — from traditional heads-up displays [176, 218] and AR/VR headsets to interactive jewelry [125, 167], makeups [86, 84, 190, 194], and even hair [191]. These wearable interfaces can be separated into two distinct groups: technologies that introduce new form factors and technologies that leverage existing ones. Leveraging a familiar form factor can alleviate concerns of social acceptability and lead to faster adoption. Additionally, established form factors come with a rich history of past use and cultural meaning. This provides a unique opportunity to design wearable technologies that reflect these practices. In this chapter, I explore the interaction capabilities of a well established head-worn form factor — hats.

Hats exist in nearly all cultures throughout the world, reflecting rich traditions over generations and acting as an extension of self [29]. Hats are diverse, and the form of the hat

conveys information about the wearer. Surgical caps, bicycle helmets, yarmulkes, ushankas, and fedoras are all worn in different contexts and have different *inherent functions*: providing protection, restraining hair, communicating religious beliefs, or attesting to personal style. This diversity of hats provides an exciting opportunity to marry function and form through the design and creation of hat technology.

This chapter discusses the design, implementation, and evaluation of hat technology. I first outline 5 design concerns for interactive hats. Next, I report results from a gesture elicitation study aimed at identifying appropriate input modalities, and extract a taxonomy of hat-based gestures. As an exemplar of how the design concerns and taxonomy can be used in practice, I discuss the implementation of three interactive hat prototypes and conduct a preliminary evaluation. Finally, I discuss implications for the design of future hat technologies.

7.2 Related Work

I briefly outline related hat-based interfaces and head-mounted gestural interfaces, focusing specifically on afforded interaction modalities.

Hat-Based Interfaces

Researchers and companies alike have begun to explore the vast potential for hats and other headwear as a location for technology. Prior work has embedded visual displays and sensors into hats as a means of personal expression, light therapy [156], EEG monitoring², and mobile device control [174]. Additionally, a number of smart helmets have been designed to increase spatial awareness and visibility of cyclists [161, 198]. Prior work has also begun to examine how hats can be used as input devices. Strohmeier et al. implemented hover and touch gestures on the crown of a beanie [174]. Mistry et al. mounted a camera to a baseball cap to characterize in-air gestures [128]. However, neither of these works justify or contextualize the choice of a hat form factor. In fact, future iterations of the work by Mistry et al. abandoned the hat completely, instead opting for a pendant form factor [127].

Head-Mounted Gestural Interfaces

While some head-mounted gestural interfaces have assumed a hat form factor [128], many more have taken other forms such as glasses (Google Glass), headsets (Microsoft HoloLens), and beyond [90]. These interfaces utilize eye tracking [164], in-air gestures [128], head gestures [223], voice commands, touch gestures, neuromuscular signals [90], or a combination of the above. For example, Microsoft HoloLens³ uses a combination of gaze, voice, and

²<http://www.smartcaptech.com/life-smart-cap/>

³<https://www.microsoft.com/en-us/hololens>

in-air gestures. Alternatively, Google Glass⁴ incorporates a suite of voice commands, head gestures, and touch gestures. In this chapter, I attempt to provide a grounded taxonomy for future designers to use in navigating potential input modalities.

7.3 Design Considerations

Hats cover a unique design space; they have different limitations and opportunities than other wearable devices, even those worn on the head. Hats combine the larger surface area of VR headsets with the casual everydayness of eyeglasses. Like hair, they can communicate personal style, but are trivially changeable. Furthermore, hats span a wide set of design concerns. They can in some contexts communicate deeply personal beliefs (e.g., at a religious ceremony) while in other contexts they can be purely utilitarian (e.g., at a construction site) or some combination of both (e.g., outdoor activities). While they are generally designed to be touched and rearranged, in some ceremonial contexts excessive touching may represent a *faux pas*.

The extensive design space for hats makes it particularly difficult to generate a set of unifying design recommendations for interactive hats. My approach, therefore, is to first describe broad design concerns and then explain how designers can reify these concerns in particular designs. To arrive at these concerns, I surveyed relevant literature on wearable devices, and applied considerations to hat form factors.

Design Considerations

1. Information Legibility

A key aspect of many wearable devices is the ability to communicate with the wearer. This communication is vital for notifications, feedback, and applications, and is often vibrotactile, aural, or visual in nature. I discuss each of these modalities in relation to the hat form factor.

A Vibrotactile. Hats tend to closely fit the wearer's head, and thus do not provide many opportunities for vibrotactile communication. Rather than eliciting a physical sensation, vibration is conducted through the bones of the skull to the inner ear, and the wearer hears a buzzing sound. However, vibration may prove effective for certain types of hats with loose-fitting features, such as lanyards, ear flaps, or tassels. Additionally, designers can leverage the buzzing from vibration motors as a mode of aural communication.

B Aural. While the close-fitting nature of hats limits haptic feedback, it enables bone conduction. Hats provide a privileged location for technology of this type, as evidenced in Kickstarter campaigns⁵ and prior work [161].

⁴<https://www.x.company/glass/>

⁵<https://www.kickstarter.com/projects/781010162/cap-on-sound-on>

C Visual. Hats also provide unique opportunities for visual communication. Most hats include a brim, typically to shield the wearer’s eyes from the sun. This portion of the hat is always visible in the wearer’s peripheral vision, and thus provides a platform to mount peripheral displays. However, these displays are close to the wearer’s eyes and could easily become overly distracting. Therefore, designers of hat technologies should take care to ensure that under-brim displays are low-fidelity and ambient [116].

Hats provide a host of potential low-fidelity modes of communication. Designers of hat technologies should consider the trade-offs between these modalities with regards to their particular domains.

2. Privacy

In addition to communicating with the wearer, wearable devices often have a means to communicate with onlookers, frequently using visual changes to convey personal style [87], emotional state [110, 70], and other types of information [144, 86, 190, 169]. Such public information is well suited for the crown: a prominent and visible portion of the hat (*aesthetics*). However, every attempt should be made to make sure the wearer is aware of the information the hat is broadcasting, especially if it is personal in nature. Additionally, prior work indicates that wearers are more comfortable displaying personal information when it is abstract, ambient, and ambiguous [38, 69, 70].

Hats must carefully consider privacy concerns, particularly with regards to displayed information.

3. Interaction Legibility

Wearable devices often provide visual or tactile indications of their interactive affordances. The Levi’s[®] Commuter X Jacquard By Google trucker jacket [109] includes visible threads in the interactive cuff; Nanya, a magnetically tracked ring for mobile device input, uses an attached disc magnet as a tactile means to inform interaction [6]; physical buttons on the side of smartwatches and activity monitors provide both visual and tactile cues. In addition to increasing *Discoverability* [136], these cues can provide feedback for input gestures. Hats are distinct in that wearers typically cannot see the surface they are interacting with; thus, tactile indications of interactive capabilities are paramount (*interaction modalities*).

Tangible landmarks provide tactile feedback and can serve as a natural place to situate interactions. Buttons and eyelets can map to discrete state selection events, while brims and lanyards can be augmented to provide continuous input.

4. Context of use

Wearable devices often sense user activity and tailor interactions accordingly. For instance, activity monitors have different functions during periods of activity and periods of rest. These devices often discern user activity using readings from embedded sensors, or communicating



Figure 7.2: Three interactive hat prototypes. Left: touch sensitive region and public crown display of the fedora prototype. Middle: personal under-brim display of the flap cap prototype. Right: user evaluation of the baseball cap prototype.

with external systems (e.g., smartphones, smartwatches, smart environments). Interactive hats may also have embedded sensors or access to these external systems; however, the form of the hat itself can also indicate user activity (e.g., bicycle helmets, surgical caps, and fedoras are all worn in very different contexts). Hat technologies should use these contexts to enact different features. For example, if a smart hardhat detects a slow ascent or descent in relative darkness, it might enable features related to climbing or spelunking. Conversely, a smart top hat may use the same sensor readings to delineate acts of a play, enabling different modes for show-time and intermission.

Interactive hats should use context to enact different features. Designers should consider available sensors and external systems, as well as the context of the hat itself (*usage patterns*).

5. Aesthetics and inherent functions

Many wearable devices assume existing form factors that have functions of their own. I refer to these as *inherent functions*. At their core, smartwatches are watches and thus need to be able to communicate time. Wearables in the form of clothing, accessories, and cosmetics are articles of personal fashion, and must fit within the wearers' sense of style. Interactive hats must also consider *inherent functions*. Hats serve a variety of purposes, and it is critical that interactive hat designers preserve them if they are valuable to the wearer. Hats can provide shelter from the sun, wind, insects, or other external sources; they can protect the head from sharp blows or pressurization (*usage patterns*); and they can communicate personal style or beliefs (*social & cultural considerations*).

Interactive hats must carefully consider aesthetics and inherent functions. Electronics should be concealed where feasible, and the visual appearance and structural integrity of the hat should be preserved as much as possible.

Category	Referent	Category	Referent
<i>Navigation</i>	Previous	<i>Simulation</i>	Answer Call
	<i>Next</i>		Hang Up Call
	Pan Left		<i>Dismiss Notification</i>
	Pan Right		Volume Up
	Pan Up		Volume Down
	Pan Down		Play
	Zoom In		Pause
	Zoom Out		Stop
<i>Editing</i>	Cut	<i>Menu</i>	Help
	Copy		<i>Open Menu</i>
	Paste		Close Menu
	<i>Delete</i>		On
	Accept	Off	
	Reject	<i>Selection</i>	Select Single
	Undo		Select Multiple
	Save		<i>Select All</i>

Table 7.1: The list of referents presented to participants grouped by category. Five gestures were repeated under additional conditions (See Table 7.3); these are shown in *pink italic*.

Embodiment of Design Concerns

Design concerns and recommendations are only useful if they can be enacted in real designs. To accomplish this, a gesture elicitation study was conducted to develop a taxonomy of hat-based gestures. This taxonomy was then applied through the lens of the design concerns to implement interactive gestures and displays on three hat styles. A second study was conducted to explore the gesture taxonomy and hat display techniques with users. Finally, I offer a broader discussion of how designers can use the gesture taxonomy and design concerns to inform the design of other interactive hats with different styles and contexts of use.

7.4 User-Defined Gestures for Hat Technology

I conducted a gesture elicitation study with 17 participants to inform interactions with hat technologies. The purpose of this study was to identify appropriate inputs to hat-worn technology and to inform the design and fabrication of future prototypes.

Elicitation Studies for Gesture Design

Gesture elicitation studies are well established in the field of HCI [216, 166, 22, 158, 99, 4, 95, 25, 187, 149]. Gesture elicitation is a technique in which users are given the result of an action (called a *referent*) and asked to propose a gesture (called a *symbol*) that would cause that result [216]. Kim et al. [95] conducted a gesture elicitation study with a variety

	Gesture Statements
G1	The gesture I picked is a good match for its intended use.
G2	The gesture I picked is easy to perform.
G3	The gesture I picked is easy to remember.
	Hat Statements
H1	Interaction with a smart hat is natural.
H2	I would prefer to interact with a smart hat over a mobile device.
H3	I would prefer to interact with a smart hat over a smartwatch.
H4	I would feel comfortable interacting with a smart hat in public.

Table 7.2: Participants in both user studies were asked to rate each individual gesture on the above gesture statements. At the conclusion of each study, participants were asked to rate the hat more generally on the above hat statements. All statements in both studies used a 7-point Likert scale.

of wearable objects as input to a small audio device. One of the objects they evaluated was a baseball cap. The work presented in this chapter contextualizes this Work-In-Progress by eliciting gestures for a wider variety of referents, extracting a taxonomy, and building prototypes capable of detecting elicited gestures.

Study Design

Selection of Referents

Towards a broad list of common tasks able to generalize gestures across a wide range of applications, referents were initially informed by those used in [216]. Adjusting this list to a wearable context, referents that were heavily dependent on external visualizations (e.g., “Rotate”, “Insert”) were removed, as well as referents that were similar in nature—in the study’s context, “Shrink”, “Minimize”, and “Zoom Out” can all be encapsulated by “Zoom Out”. Referents specific to phones and wearable devices (e.g., “Answer Call”, “Dismiss Notification”, “Volume Up”, etc) were added, as well as panning gestures. Referents were then grouped in five of the six categories used in both Chan et al.’s elicitation study for single-hand microgestures [25] and Piumsomboon et al.’s elicitation study for augmented reality [149] (none of the remaining referents fell under their “Transform” category). Finally, the “Browsing” category was renamed to “Navigation”, to better suit the wearable context. Thus, 32 referents are clustered into 5 categories: Navigation, Editing, Simulation, Menu, and Selection (See Table 7.1).

Selection of Hat

The gesture elicitation study was conducted using a plain baseball cap (See Figure 7.3). This type of hat was chosen because they are relatively ubiquitous in the Western society in



Figure 7.3: The baseball cap used in the gesture elicitation study.

which the study took place.

“Infinite Technology”

Participants were explicitly instructed not to think about technical implementation and assume that any conceivable gesture would be recognized.

Legacy Bias

Several measures were taken to reduce legacy bias. *Legacy bias* occurs when participants’ gesture proposals are biased by their experience with prior interfaces, interaction paradigms, and technologies [131]. The study design applied two techniques to reduce legacy bias: *priming* and *production* [131]. The study design applied *priming* by asking participants to imagine two additional conditions: that their hands were dirty but mobile, and that their hands were preoccupied and immobile (See Table 7.3). The study design applied *production* by asking participants to propose two gestures for each referent.

Additional Conditions

Participants were asked to repeat 5 referents (Table 7.1, pink italic) under two additional conditions: Hands Dirty and Hands Preoccupied (Table 7.3). These conditions were chosen to highlight advantages of hat-worn technology, namely that it can support hands-free interaction with personal and public devices alike.

Condition	Explanation to Participants
<i>Hands Dirty</i>	Imagine your hands are dirty. Perhaps you are cooking or changing the oil in your car. You can move your hands around, but you do not want to physically touch the hat.
<i>Hands Preoccupied</i>	Imagine your hands are full. Perhaps you are soldering or carrying a bunch of items. You cannot move your hands.

Table 7.3: After participants had completed the 32 gestures, they repeated 5 of those gestures under two additional conditions: hand dirty and hands preoccupied.

Using hat interactions, a cook could pause music that they are listening to, have a conversation on their smart phone, and then resume listening to their music without contaminating food they are preparing. An engineer could zoom in on a circuit diagram without putting down their soldering iron and losing their place on the PCB.

Participants

The gesture elicitation study had 17 participants (15 male, 2 female). Participants were recruited using email lists and word of mouth. The participants ranged in age from 18 to 65 (Mean = 37.5, SD = 13.2). Fifteen participants were right handed, one left handed, and one ambidextrous. All participants owned smartphones and laptops and rated themselves as using them on a daily basis. Thirteen participants owned tablets; 8 participants owned a smartwatch. While not a requirement for participation, all participants owned at least one type of hat, and ranged from wearing them daily to rarely (“several days in the winter” or “only in summer”). The study took around 45 minutes to complete.

Procedure

I first gathered background experience with headwear and technology. This information was collected to contextualize results, particularly with respect to legacy bias. Participants were then given a plain gray baseball cap (Figure 7.3) to wear during the study. Participants were instructed to wear the hat as they normally would. Only 1 participant chose to wear the hat “backwards”; all other participants wore the hat with the brim in the front (as in Figure 7.10).

Participants were presented with a total of 32 referents, broken up into 5 categories based on function (See Table 7.1). The resulting effects (*referents*) were verbally described and participants were asked to design and perform an input gesture (*symbol*). Participants were asked to design two gestures for each referent, before identifying which they preferred. After the participants had decided upon a gesture, the participants were asked to rate the

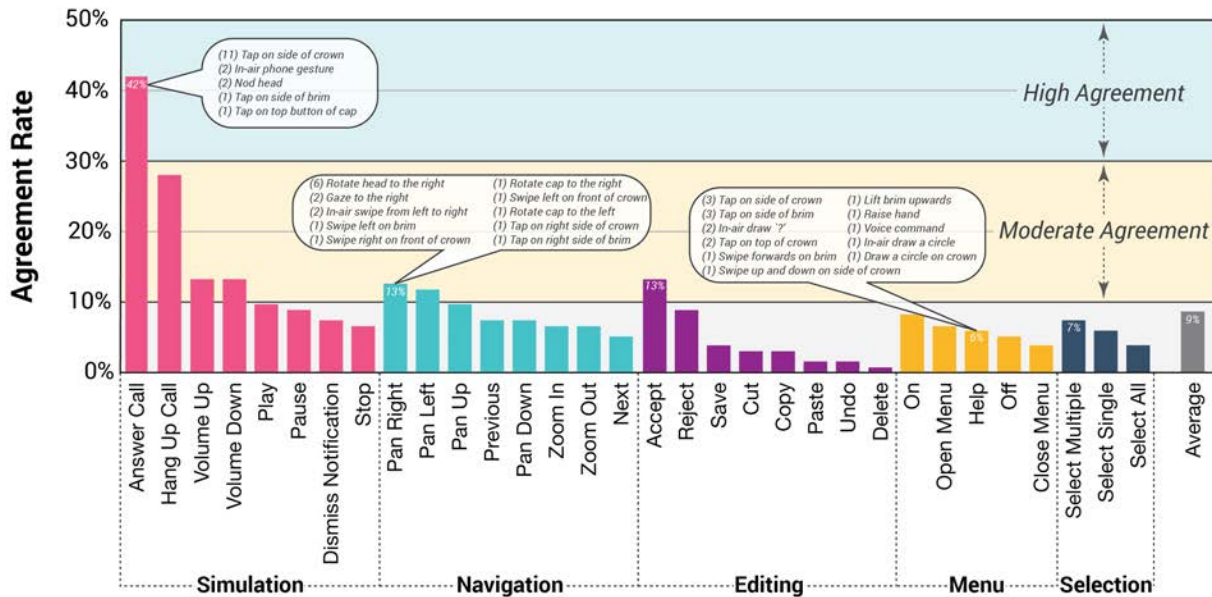

Figure 7.4: Agreement rates for the 32 referents, arranged by category. The complete set of elicited gestures for Answer Call, Pan Right, and Help are shown in the superimposed boxes; the number in parentheses is the number of participants that proposed a given gesture. Agreement rates of less than 10%, between 10% and 30%, and between 30% and 50% are considered low, moderate, and high agreement respectively [186].

gesture using a 7-point Likert scale on 3 statements (See “Gesture Statements” in Table 7.2). Referents were always presented in the same order. Participants were allowed to repeat a single gesture for multiple referents, if desired.

After completing the 32 referents, the participants were asked to repeat 5 of the referents (Table 7.1, pink italic) under two additional conditions: Hands Dirty and Hands Preoccupied (Table 7.3). Inspired by the conceptual complexity ratings utilized in [216], these tasks were chosen to cover a range of category types and complexities.

The study concluded with an assessment questionnaire. Participants were asked to rate the interactions more generally using a 7-point Likert scale on 4 statements (See “Hat Statements” in Table 7.2). All interview meetings were video and audio recorded, transcribed, and analyzed using grounded theory. In total, each participant was presented with 42 tasks (32 initial tasks + (5 representative tasks x 2 conditions)).

Analysis

With 17 participants, 1,428 gestures were made, collected, and analyzed (17 participants x 42 tasks x 2 gestures). The data collected includes transcripts, videos, preliminary question-

naires, and gesture & hat rankings (Table 7.2).

Similar to prior gesture elicitation studies [25, 149, 158], similar gestures were grouped together, rather than solely identical gestures. Tapping the front of the crown with 1 finger was considered equivalent to performing the same gesture with 2, 3, or 4 fingers. Tapping once on the left side of the brim was considered equivalent to tapping twice or more. For gestures performed on a particular side (e.g., tap on the right side of the crown), participants were asked if the gesture had to be performed on that side, or if it was side independent. This was factored in to the results and analysis.

Results

I detail agreement rates for referents, define a consensus set for hat-based gestures, discuss participant preferences for input modalities, and report qualitative findings. Only participants' preferred gestures are included in the figures, results, and analysis. For reference, the list of all participants' preferred gesture proposals for the entire set of referents is included in Figure 7.5.

Agreement

Agreement rates were calculated to quantify consensus between participants. The equation for calculating agreement rate is [186]:

$$AR(r) = \frac{|P|}{|P| - 1} \sum_{P_i \subseteq P} \left(\frac{|P_i|}{|P|} \right)^2 - \frac{1}{|P| - 1}$$

where P is the set of all proposals for referent r , $|P|$ the number of elicited proposals for that referent, and P_i subsets of identical proposals from P [186]. An agreement rate of 1.0 would indicate that every participant performed the exact same gesture; an agreement rate of 0.0 would indicate that every participant performed a unique gesture. Agreement rates were calculated using the Agreement Analysis Toolkit (AGATe v2.0) [186].

Agreement rates ranged from 0.01 (low agreement, $AR < 0.10$) to 0.42 (high agreement, $0.30 < AR < 0.50$). The average agreement rate was 0.09. As mentioned previously, only preferred gestures are considered in the analysis. The agreement rates of all referents can be found in Figure 7.4.

Consensus Set

For each referent, similar gestures were grouped together. The gesture with the largest consensus was chosen to be the consensus gesture for that referent. If at least 5 participants agreed on the consensus gesture, it was included within the consensus set (See Figure 7.7). With the exception of Reject ($AR = 0.09$), every gesture in the consensus set had moderate to high agreement.

	Referent	Proposed Gestures
Navigation	Previous	Backwards swipe on side of crown , rotate head to the left, in-air swipe from right to left, tap on left side of crown, tap on left side of brim, tap on right side of crown, swipe left on brim, backwards swipe on brim, swipe down on left side of crown, rotate cap to the right
	Next	Swipe forwards on brim , rotate head to the right, in-air swipe from left to right, tap on right side of crown, tap on right side of brim, swipe forwards on side of crown, backwards swipe on right side of crown, swipe right on front of crown, swipe right on brim, swipe down on right side of crown, rotate cap to the left
	Pan Left	Rotate head to the left , gaze to the left, swipe right on brim, rotate cap to the left, in-air swipe from left to right, in-air swipe from right to left, swipe left on front of crown, rotate cap to the right, tap on left side of crown, tap on left side of brim, swipe right on front of crown
	Pan Right	Rotate head to the right , gaze to the right, in-air swipe from left to right, swipe left on brim, rotate cap to the right, swipe right on front of crown, rotate cap to the left, tap on right side of crown, tap on right side of brim, swipe left on front of crown
	Pan Up	Tilt head up , gaze up, in-air swipe down, swipe up on front of crown, backwards swipe on brim, in-air swipe up, lift brim upwards, swipe up on side of crown, tap on front of crown, tap on center of brim
	Pan Down	Tilt head down , gaze down, in-air swipe up, swipe forwards on brim, swipe down on front of crown, pull brim downwards, in-air swipe down, swipe down on side of crown, tap on back of crown, tap on center of brim
	Zoom In	Swipe forwards on side of crown, close pinch on crown , in-air open pinch, swipe forwards on brim, open pinch on brim, move head forward, in-air pinch and pull hand backwards, lift cap off, in-air close pinch, tap on right side of brim
	Zoom Out	Swipe backwards on side of crown, open pinch on crown , in-air close pinch, swipe backwards on brim, close pinch on brim, move head backwards, in-air pinch and move hand forward, rotate cap side to side, in-air open pinch, tap on left side of brim
	Editing	Cut
Copy		Tap on side of brim , tap on side of crown, tap on front of crown, tap on center of brim, swipe forwards on right side of brim, swipe side to side on brim, nod head, in-air place palms together and then lift top hand off the bottom hand, in-air pinch and pull hand back, in-air point at object, "Copy", lift cap off, blink
Paste		Tap on center of brim, in-air open pinch, tap on side of brim, tap on side of crown, tap on top of crown, tap on front of crown, backwards swipe on right side of brim, swipe forwards on right side of crown, tilt head up, rotate cap to the left, lift cap off, in-air place palms together and then slide the top hand off the bottom hand, in-air point at place to paste, in-air hold left palm face up and then place right hand over left, blink
Delete		In-air swipe from left to right, backwards swipe on left side of brim, swipe left on front of crown, swipe left on brim, swipe forwards on brim, tap on back of crown, draw an 'X' on crown, in-air swipe from right to left, in-air close pinch, in-air open pinch, in-air wave, lift cap off, shake head, rotate head to the left, rotate cap 360 degrees on head, blink
Accept		Nod head, In-air thumbs up , tap on right side of crown, draw a circle on crown, draw a checkmark on crown, swipe right on brim, in-air "okay" gesture, rotate cap 360 degrees on head
Reject		Shake head , draw an 'X' on crown, tap on left side of crown, in-air thumbs down, in-air make an 'X' with pointer fingers or arms, swipe left on brim, swipe left on front of crown, in-air wave, lift cap off
Undo		In-air draw circle, swipe left on brim, swipe left on front of crown, backwards swipe on left side of crown, swipe back and forth on side of crown, tap on back of crown, tap on left side of crown, tap on left side of brim, tap on left side of brim then tap on right side of brim, tap on center of brim, shake head, rotate cap side to side, tilt head up, in-air extend hand and pull back, in-air rotate wrist 180 degrees
Save		Tap on top of crown, in-air swipe down, swipe down on side of crown, tap on side of crown, tap on side of brim, tap on back of crown, tap on front of crown, swipe up on front of crown, in-air thumbs up, in-air close pinch, rotate cap 180 degrees on head, "Save"
Simulation		Answer Call
	Hang Up Call	Tap on side of crown , in-air phone gesture, tap on back of crown, in-air swipe down, swipe down on side of crown, tap on side of brim, tap on top of crown
	Dismiss Notification	Tap on side of crown, swipe right on brim , in-air swipe from left to right, in-air swipe up, swipe down on side of crown, swipe down on back of crown, swipe left on back of crown, swipe backwards on side of crown, swipe up on front of crown, pull brim downwards, shake head
	Volume Up	Swipe up on side of crown , swipe forwards on side of crown, in-air swipe up, in-air rotate wrist clockwise, rotate cap to the right, swipe forwards on brim, swipe up on front of crown, draw a clockwise circle on crown, tap on side of brim
	Volume Down	Swipe down on side of crown , swipe backwards on side of crown, in-air swipe down, in-air rotate wrist counter-clockwise, rotate cap to the left, swipe backwards on brim, swipe down on front of crown, draw a counter-clockwise circle on crown, tap on top of crown
	Play	Tap on side of crown , tap on center of brim, tap on front of crown, swipe forwards on brim, tap on side of brim, tap on top of crown, swipe forwards on side of crown, in-air swipe down, "Play", lift brim upwards
	Pause	Tap on side of crown, tap on side of brim , tap on top of crown, tap on front of crown, tap on center of brim, in-air swipe down, swipe down on side of crown, "Pause", lift brim upwards
	Stop	Tap on side of crown , tap on side of brim, tap on top of crown, lift cap off, tap on center of brim, tap on front of crown, swipe up on front of crown, swipe down on side of crown, backwards swipe on brim, in-air draw an 'S', "Stop"
	Menu	Help
Open Menu		Tap on side of brim , tap on side of crown, swipe forwards on brim, open pinch on crown, lift brim upwards, in-air two hand gesture from center outwards, tap on back of crown, in-air tapping gesture, in-air swipe up, gaze down, tap on top of crown
Close Menu		Tap on side of brim , tap on side of crown, close pinch on crown, backwards swipe on brim, pull brim downwards, in-air two hand gesture from sides to center, tap on back of crown, in-air draw an 'X', backwards swipe on side of crown, in-air swipe down, gaze up, tap on top of crown, swipe right on brim
On		Tap on side of brim, tap on top of crown , in-air open pinch, tap on center of brim, in-air swipe down, lift brim upwards, swipe up on front of crown, in-air checkmark gesture (hand pose), tap on side of crown, draw a circle on crown
Off		Tap on top of crown, tap on side of brim , tap on center of brim, in-air open pinch, in-air swipe up, lift brim upwards, swipe down on front of crown, in-air thumbs down, in-air close pinch, tap on side of crown, draw a circle on crown, tap on back of crown
Selection	Select Single Item	Look at object and tap on side of crown, look at object and tap on side of brim , point at object, tap on front of crown, backwards swipe on brim, gaze intently at object, in-air draw a circle around object, in-air close pinch on object, look at object and blink, look at object and nod head, tap on area of crown that corresponds to the object
	Select Multiple Items	Look at object and tap on side of brim, point at objects , in-air draw a circle around objects, tap on area of crown that corresponds with object, backwards swipe on brim, look at each object and nod head, look at each object and blink, swipe right on front of crown, tap on side of crown, multi-finger tap on brim (which fingers used corresponds to which objects to select), hold brim with one hand and draw circles on the crown with the other to move the pointer and tap on the crown to select items
	Select All	Tap on both sides of brim , tap on top of crown, extend hand forwards, swipe right on brim, draw circle with head, in-air diagonal swipe, in-air swipe from left to right, lift cap off, in-air draw rectangle, swipe right on front of crown, tap on side of crown, draw a circle on crown, press whole hand against brim
Hands Dirty	Next	Rotate head to the right, in-air swipe from left to right , tap on side of crown (with back of hand or arm), tilt head to the right, "Next", in-air swipe from right to left
	Dismiss Notification	Shake head, In-air swipe from right to left , tilt head up, in-air backwards swipe, in-air swipe from left to right, in-air swipe down, in-air wave, in-air swipe up, tilt head to the left, backwards swipe on side of crown (with back of hand or arm), swipe left or right on brim (with arm)
	Delete	Shake head , in-air backwards swipe, in-air swipe from left to right, rotate head to the left, in-air swipe from right to left, in-air wave, in-air open pinch, tap on side of crown (with back of hand), tap on side of brim (with arm), in-air close pinch, "Delete"
	Open Menu	Tilt head up , nod head, in-air two hand swipe from center outwards, in-air backwards swipe, extend hand forwards, in-air swipe up, gaze down, tap on front of crown (with back of hand or arm), open pinch on crown (with wrists), snap fingers, tilt head down, "Alexa"
Hands Preoccupied	Select All	Draw circle with head , in-air close pinch, tap on top of crown (with arm), extend hand forwards, in-air diagonal swipe, in-air swipe from left to right, in-air draw a rectangle
	Next	Rotate head to the right, tilt head to the right , "Next", gaze to the right
	Dismiss Notification	Shake head, tilt head down, tilt head up , "Dismiss", rotate head to the left, gaze up, tilt head to the left
	Delete	Shake head, tilt head down, rotate head to the left , "Delete", tilt head up then right then down then left, tilt head to the left
	Open Menu	Tilt head up, tilt head down, voice command ("Open Menu" or "Alexa") , nod head, draw circle with head, gaze intently, gaze down
Select All	Draw circle with head , tilt head down, tense jaw, blink, "Select All", tilt head up	

Figure 7.5: Complete set of gestures proposed by participants for all referents in the gesture elicitation study. Gestures suggested at least 3 times are highlighted in bold; gestures suggested at least 5 times are shown in bold pink.

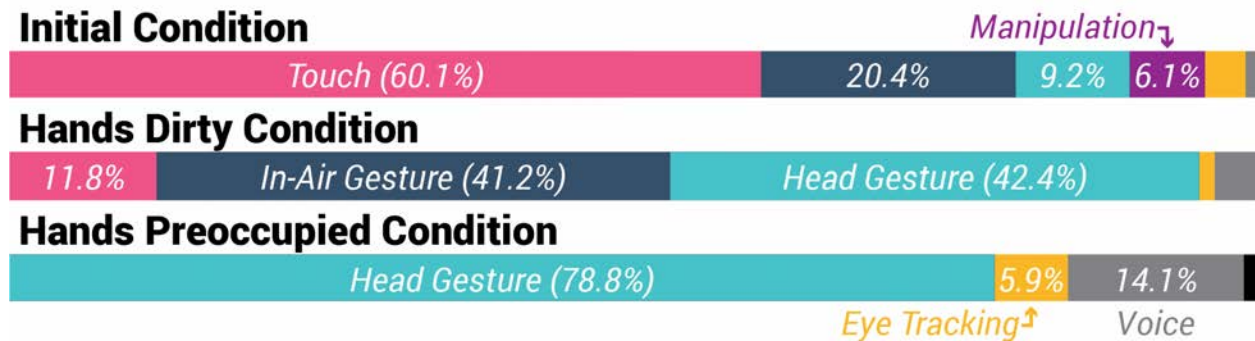

Figure 7.6: Classification of 544 preferred gestures in the initial condition (no constraints), 85 preferred gestures in the *Hands Dirty* condition, and 85 preferred gestures in the *Hands Preoccupied* condition. In the *Hands Preoccupied* condition, 1 participant proposed a neuromuscular sensing gesture (*Tense Jaw*), shown in black on the right.

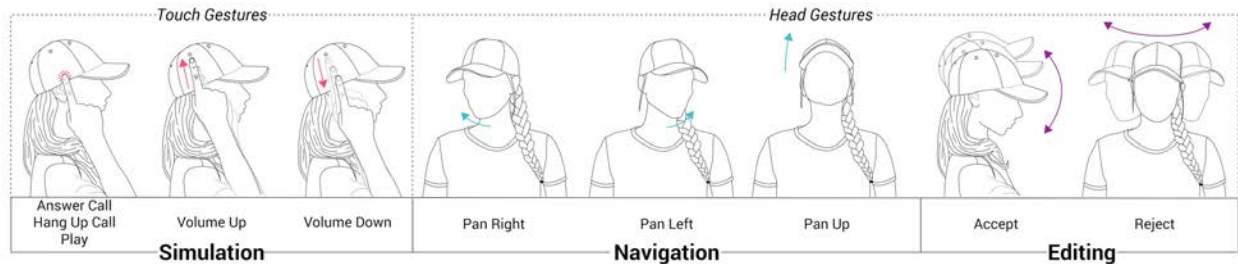

Figure 7.7: Consensus gesture set arranged by category and type of gesture.

Emerging Themes

Touch Gestures Preferred; Voice Gestures Avoided

The results indicate that touch gestures are preferred over other input modalities. Out of the 544 preferred gestures in the initial condition (no constraints), 327 (60.1%) were touch gestures. Two participants continued to prefer touch gestures in the *Hands Dirty* condition, opting to touch the hat with other parts of their body, such as their wrists and arms. Conversely, participants seldom preferred voice gestures over other input modalities. Out of the 714 preferred gestures (from all conditions), only 21 were voice gestures (2.9%). Only 1 participant opted for voice gestures in the initial condition (no constraints). Two other participants used voice gestures in the following conditions (hands dirty, hands preoccupied); however, this type of gesture was often seen as a last resort.

I can't think of a good head gesture [so I would] say the word "delete" (P6).

In-Air Gestures Have Lower Agreement

While 111 preferred gestures in the initial condition (20.4%) were in-air gestures, this modality had lower agreement. Despite an increase of in-air gestures in the *Hands Dirty* condition (41.2% of preferred gestures), agreement rates did not rise similarly. For “Select All” under the *Hands Dirty* condition, the 17 participants converged on only 7 different gestures: 1 head gesture, 1 touch gesture, and 5 distinct in-air gestures. Whereas touch gestures are physically constrained by the form of the hat, head gestures are physically constrained by human anatomy, and manipulation gestures are constrained by a combination of the two, in-air gestures have a broader input space with less restrictions on potential inputs.

Constraints Increase Agreement

The *Hands Dirty* condition largely eliminated touch and manipulation gestures. The *Hand Preoccupied* condition eliminated touch, manipulation, and in-air gestures (See Figure 7.6 for a breakdown of gesture types across conditions). With fewer input modalities available, participants were more likely to agree on an appropriate gesture. In the *Hands Dirty* condition, 3 of 5 tasks had higher agreement than in the initial condition. In the *Hands Preoccupied* condition, all 5 referents had higher agreement than in the initial condition, all 5 referents had at least moderate agreement, and 1 task (Select All) had high agreement (See Figure 7.8). This suggests that limiting the space of potential inputs increases agreement. This is especially relevant for headwear associated with particular domains that require hands-free interaction (e.g., surgical caps, bicycle helmets).

Tangible Landmarks Can Inform Potential Touch Gestures

22 preferred touch gestures in the initial condition (6.7%) used features specific to the baseball cap such as the back strap, button, and eyelets. Participants who used these *tangible landmarks* were drawn to their tactile affordances.

This feels like a button (P14).

It's such a tactile thing, it feels like [On/Off] should be there (P7).

Implications for Design

As illustrated in the consensus set (See Figure 7.7), gestures with the highest agreement were touch gestures on the crown and head gestures. While touch gestures had higher agreement, qualitative results indicate that participants are more interested in using a hat in situations where their hands are full or preoccupied. Thus, these interaction modalities should be prioritized similarly. From the 1,428 gestures performed during the elicitation study, I extracted a taxonomy of hat-based gestures (See Table 7.4). Although the taxonomy is informed by interactions with a baseball cap, the taxonomy can be tailored to other types

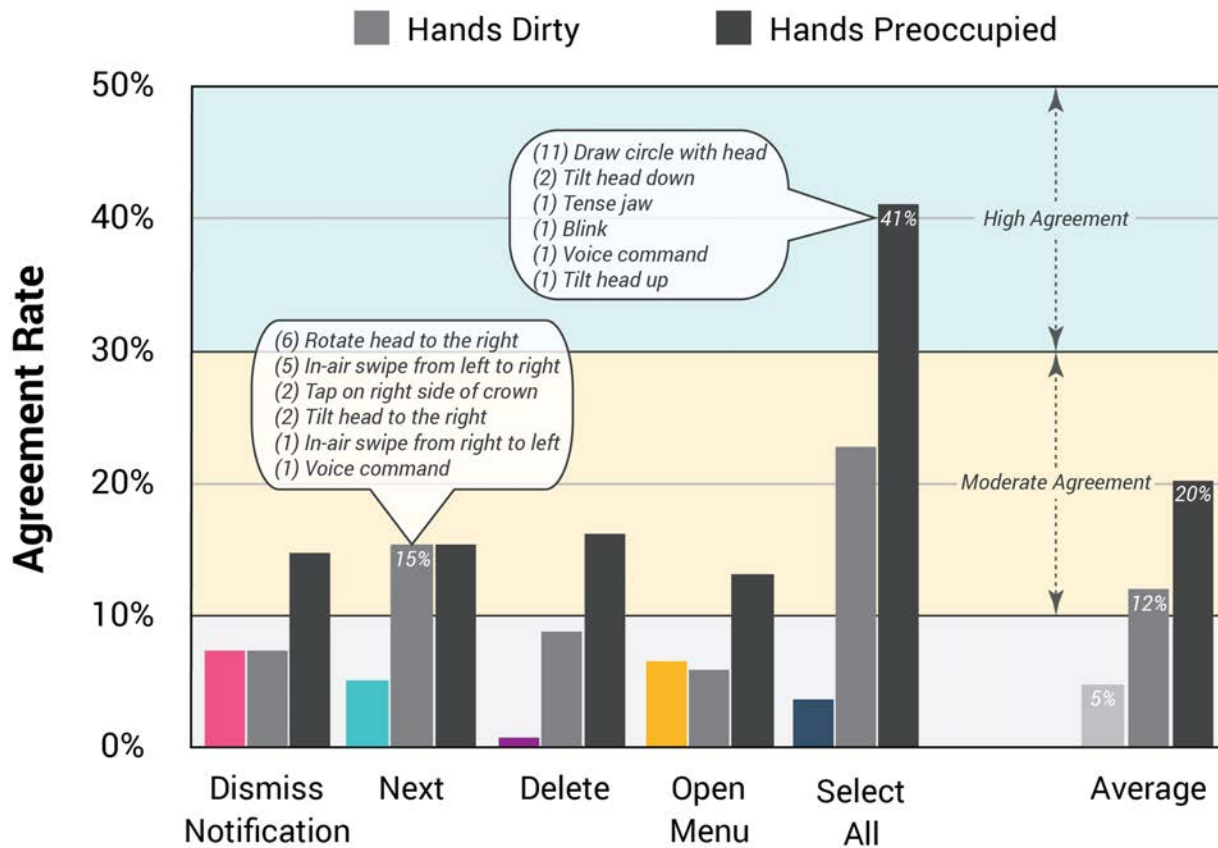

Figure 7.8: Agreement rates for the 5 referents repeated under 3 conditions: no constraints, hands dirty but mobile, and hands preoccupied and immobile.

of hats, particularly with regards to potential touch and manipulation gestures. The other modalities (Eye Tracking Gestures, In-Air Gestures, Head Gestures, and Voice Gestures) do not depend on the physical form of the hat, and thus can be applied to other types of hats without adjustment.

7.5 Design and Fabrication of Interactive Hats

Informed by the elicitation study and design concerns, I designed and fabricated three hat prototypes capable of sensing touch and head gestures, and including ambient displays of several types. Three separate prototypes were developed to illustrate how the design concerns and taxonomy could be applied to distinct hats with varying physical affordances, associated contexts, and levels of formality. The prototypes include a baseball cap, a fedora, and a flat cap (See Figure 7.9).

Class	Characteristics	
Touch	<i>Location</i>	brim, crown, button, strap, eyelet
	<i>Type of Gesture</i>	tap, stroke, pinch, draw
	<i>Handedness</i>	one handed, two handed
Manipulation	<i>Type of Gesture</i>	lift, pull, rotate
	<i>Handedness</i>	one handed, two handed
Eye Tracking	<i>Point of Reference</i>	hat, interface
In-Air	<i>Point of Reference</i>	head, body, interface
	<i>Type of Gesture</i>	wave, pose, swipe, draw, pinch, point
	<i>Handedness</i>	one handed, two handed
Head Gesture	<i>Type of Gesture</i>	rotate, tilt, move, draw, gesture
Voice	<i>Mapping</i>	direct, abstract

Table 7.4: Taxonomy of head-based gestures based on 1,428 collected gestures.

An Adafruit Feather 32u4 Bluefruit LE microcontroller is sewn into each hat. The battery is a rechargeable lithium ion battery that is tucked into the facing of the crown for easy access. The hat prototypes use Bluetooth LE to connect to external devices and displays and advertise their input and output capabilities over BLE using existing protocols⁶.

Enabling Touch Interactions

Capacitive touch sensing is implemented on the sides of the crown using an Adafruit MPR121 Capacitive Touch Sensor and a grid of strips of conductive fabric. By detecting simultaneous changes in the capacitance of both horizontal and vertical strips of conductive fabric, the system can detect the location of touch and characterize gestures such as swipes forwards, backwards, up, and down. While the design could leverage past work to improve capacitive sensing techniques and capabilities [174, 159], the presented implementation meets a key design concern: *preserving the inherent functions* of each hat type.

Sensing Head Gestures

Head gestures are sensed using an Adafruit BNO055 Absolute Orientation Sensor IMU. The IMU is embedded in the brim or sewn into the facing of the crown. The system uses simple thresholds to detect and classify 6 distinct head gestures: *Rotate head to the left*, *Rotate head to the right*, *Tilt head up*, *Tilt head down*, *Nod head (up and down)*, *Shake head (side to side)*. Incidentally, the implementation is also capable of detecting similar hat

⁶<https://www.bluetooth.com/specifications/gatt>



Figure 7.9: Three hat prototypes. Left: baseball cap prototype. Middle: flat cap prototype. Right: fedora prototype.

manipulations: *Rotate hat to the left, Rotate hat to the right, Lift brim up, Pull brim down, Wiggle brim up and down, Wiggle brim side to side.*

Ambient Displays

Unlike other clothing and accessories, hats are unique in that part of the hat (the brim) is always visible in the wearer’s peripheral vision, whereas another part of the hat (the crown) is never visible to the wearer. Inspired by these physical affordances, the hat prototypes include two visual ambient displays: one on the underside of the brim intended for the wearer to see, and one on the crown intended for others to see.

Personal Under-Brim Display

The baseball cap and flat cap were augmented with RGB LEDs on the underside of the brim (See Figure 7.10 (Left) and Figure 7.2 (Middle)). The LEDs are angled such that they project light onto the entire underside of the brim. The under-brim display can be used to provide feedback, indicating that a gesture has been correctly identified or communicating acknowledgments received from Bluetooth connected devices. This display is also capable of delivering ambient notifications in the user’s peripheral vision, allowing them to continue their work without distraction and persisting in noisy environments.

A smart surgical cap could notify a surgeon of patient biometrics without having to avert their gaze. A smart bicycle helmet could notify a cyclist of an upcoming detour without distracting them from the road. A concert-goer could receive text alerts on their hat, unable to feel the vibration of their phone over the vibration of the bass.



Figure 7.10: The implemented interactive hats included two different classes of ambient displays. Left: personal under-brim display. Right: public crown display.



Figure 7.11: Hat prototypes capable of sensing touch and head gestures. The baseball cap (top) has ambient displays under the brim and across the crown; the fedora (middle) has an ambient display across the crown; and the flat cap (bottom) has an ambient display under the brim. In all three prototypes, the battery is tucked into the facing on the inside of the crown.

Public Crown Display

Sewable NeoPixels were integrated into the eyelets of the baseball cap and across the crown of the fedora (See Figure 7.11). Following suggestions outlined in prior work [38], these public displays are low fidelity, ambient, and ambiguous in nature.

An external system could use the crown display to track the wearer through a smart environment. Additionally, crown displays could be used to communicate emotional state and interruptibility between coworkers.

Leveraging the Physical Differences of Hats

While all three of the hat prototypes incorporate both sensing modalities (touch and head gestures), ambient displays are implemented opportunistically and informed by the physical form of the hat. The baseball cap includes both ambient displays. The fedora has a shorter brim, so it does not include an under-brim display. The flat cap has a less structured crown, so it does not include a public crown display.

Tangible landmarks were implemented where possible. The elicitation study identified the button on top of the baseball cap’s crown as the most prominent landmark (over the back strap, eyelets, and other features). Thus, this feature of the hat was instrumented with conductive fabric. The presented designs took care to preserve the *aesthetics and inherent functions* of each hat, preserving the overall appearance and concealing electronics where possible.

7.6 Evaluation

I conducted an evaluation of the designed prototypes and gestures obtained from the elicitation study. The evaluation had 10 users (5 male), none of which took part in the elicitation study. Users were recruited using email lists and word of mouth, and ranged in age from 21 to 55 (Mean = 37.7, SD = 12.6). All users were right handed. The study had two parts: (1) Gesture Recognition, and (2) Task. All study procedures were video and audio recorded, transcribed, and analyzed.

Gesture Recognition

The study first measured the accuracy of implemented sensing techniques. Users were instructed to wear the hat prototype and were shown 8 gestures: *Pan Left*, *Pan Right*, *Pan Up*, *Pan Down*, *Volume Up*, *Volume Down*, *Zoom In*, *Zoom Out*. Five of these gestures are contained in the consensus set (See Figure 7.7); the other gestures were swiping forwards/backwards on the side of the crown (*Zoom In/Out*, respectively), and tilting the head down (*Pan Down*). These gestures were chosen to evaluate both touch and head gestures, and to include gestures that had moderate agreement (*Volume Up* and *Volume Down*), as

well as gestures with low agreement (*Zoom In* and *Zoom Out*). After the gestures had been demonstrated, users were prompted to perform each gesture 10 times in a row, for a total of 80 gestures.

Task

Users were then instructed to complete a task using the hat as an interface (See Figure 7.2, right). Users were instructed to pan across an image to align crosshairs with 5 targets of differing sizes. Once inside each target, users were instructed to adjust the volume up or down. This task required panning in all four directions to find the targets, zooming to get the crosshairs completely inside the target, and adjusting the volume in both directions. The under brim LEDs flashed to indicate an acquired target.

Implementation: During Gesture Recognition, the hat communicated over BLE with a python script running on a laptop. For each recognized gesture, the hat sent the name (e.g., “Zoom Out”) to the python script. This log was closely tracked, and the number of recognized gestures was recorded. During the Task, a modified version of the python script sent calls to the server hosting the task. The code running on the hat did not change between parts of the study.

Results

Accuracy

The study revealed significantly different accuracy for head gestures (*Pan Left/Right/Up/Down*) and touch gestures (*Zoom In/Out, Volume Up/Down*). The system achieved 100% accuracy for head gestures using a 15° tolerance (rotating/tilting the head 15° in any direction resulted in a panning gesture). The system achieved mean accuracy of 35.5% for touch gestures. Low accuracy for touch gestures can be attributed to a number of different factors: no training session, lack of calibration between users, absence of feedback, and insufficient indication of where to touch.

I do not have very good spatial awareness of my gesture directions while touching my head (U6).

During the task, the connected display provided visual feedback indicating whether or not gestures had been recognized. With this feedback, accuracy rates improved. Users took an average of 3 minutes 16 seconds to complete the task using the hat prototype (Max = 6 minutes 30 seconds; Min = 1 minute 50 seconds). While accuracy rates were low, they were sufficient for characterizing user thoughts and reactions to the hat prototype and associated gestures.

Perception of gestures

Users ranked each gesture on the same set of statements used in the initial elicitation study (See “Gesture Statements” in Table 7.2), allowing direct comparison of the thoughts and reactions of this set of users to the participants who initially suggested using such gestures. Users were clearly biased by the recognition capabilities of the system. On all three statements, users in the second study ranked gestures with high accuracy rates (head movements - panning gestures) higher than the participants in the first study. Conversely, these users ranked gestures with low accuracy rates (touch gestures - volume up/down, zoom in/out) lower than the participants in the first study. This was true for all three gesture statements.

Perception of hat technology

Users also ranked the hat technology more generally using the same 4 statements from the first user study (See “Hat Statements” in Table 7.2). In both studies, these statements received middling ratings. One explanation for this emerged through conversations with users; hat interfaces are desirable in specific contexts but not in general use. While no user imagined swapping out their Smartphone or mobile device for a hat, 8 out of 10 users imagined concrete situations in which they would use hat technology.

It would be nice to use [hat technology] for navigation when you are doing outdoor activities such as hiking and jogging (U10).

[Hat technology] could be very useful for hospitals and restaurants. Scenarios where professionals wear hats for their daily work (U6).

Users also imagined using hat-worn technology when biking (U4), controlling a television (U8), carrying something (U9), and “anytime when your hands are full and voice is not an option” (U3). Users were particularly drawn to the idea of “hands-free” interaction (U3, U5, U6, U8, U10).

Response to under-brim ambient display

While this evaluation mainly served to garner feedback on input modalities, it also elicited feedback on the under-brim display. When asked to rank how noticeable the display was on a 7-point Likert scale (1=Not noticeable, 7=Very noticeable), users gave it an average ranking of 5.2 ± 1.7 , and responded positively to this display.

The [under-brim display] could be useful even without the input elements. For example, if I want to know that a device was listening to me, or other notifications, these lights could be useful (U3).

The LED light gives me implicit feedback, which I like a lot compared to audio notifications. [It feels] less distracting (U6).

Limitations

While users in the prototype evaluation responded positively towards the hands-free capabilities and under-brim display, interactive hats should be evaluated in real-life contexts. The study evaluated seated users interacting with an external display. Future work should examine a wider range of contexts including interactions with smartphones and IoT devices, as well as situations in which the user is standing, running, working, or doing a number of other activities. Finally, both of the studies were influenced by the culture in which they took place. All of the participants were educated adults in a Western society; the results are likely not generalizable across cultures. Further work is necessary to contextualize results across a broader society [122].

7.7 Discussion

Given the diversity of hat styles and contexts of use, the implementation presented in this chapter barely scratches the surface. However, the design concerns and gesture taxonomy can be tailored to inform a variety of interactive hats. Factors to consider are physical form (*physicality*), *inherent functions*, and *context of use (usage patterns)*.

Physical Form

The physical form of the hat influences the first three design concerns: how personal and public information is communicated, and potential *tangible landmarks*.

Brimless hats (e.g., yarmulkes, berets, kufi caps) do not lend themselves to under-brim displays or manipulation gestures, as there is not a natural place for users to grip and manipulate the hat. Bone conduction capabilities are largely unaffected by the physical form of the hat; however, as mentioned previously, vibration may prove effective for certain types of hats with loose-fitting features, such as lanyards, ear flaps, or tassels. Hats with structured crowns (e.g., top hats, fedoras, hardhats) are better substrates for crown displays than hats with flexible or non-existent crowns (e.g., flat caps, beanies, fascinators).

Hats also vary in terms of *tangible landmarks*. Hats may feature lanyards that secure underneath the chin (e.g., stetsons, fishing hats, party hats), eyelets or holes for ventilation (e.g., baseball caps, hardhats), decorative ribbons or bands (e.g., fedoras, stetsons), and logos/designs (e.g., baseball caps, beanies). This is just a small subset of potential *tangible landmarks* for hat technologies. Gesture taxonomies for hat interactions should be tailored with respect to these *tangible landmarks*; while other input modalities are largely unaffected by the form of the hat, potential touch and manipulation gestures largely depend on physical form.

Inherent Functions

Inherent functions of hats are a key design concern that should influence the design and fabrication of hat technologies. More formal hats (e.g., top hats) should prioritize subtle interaction capabilities and discreet technology. Hats worn explicitly for protection from the sun (e.g., sun hats) are less suited for visual displays that are less visible in direct sunlight.

Contexts of Use

Finally, associated *contexts* of hats can inform the technologies and capabilities that should be embedded in them. Hats typically worn outdoors (e.g., sun hats, baseball caps, fishing hats) are a natural substrate for light sensors and other measures of sun exposure. Hats associated with jobs (e.g., hardhats, hairnets) provide opportunities for networked interactions. Hats worn in noisy contexts (e.g., safety helmets, pilot/stewardess hats) should avoid using bone conduction so as to minimize the risk for cochlear damage.

7.8 Summary

This chapter explored hats as a highly contextual body-worn artifact (See Figure 7.1 for various contexts of use), and leveraged the framework to surface differences between hat form factors in terms of *physical form*, *inherent functions*, and *contexts of use*. I highlighted key design considerations for hat technologies related to *interaction modalities* (interaction legibility), *usage patterns* (context of use & inherent functions), and *aesthetics & expressive output* (information legibility & privacy).

I described a gesture elicitation study conducted to inform interactions with hat technologies. Study results included agreement rates for referents, a consensus set & gesture taxonomy for hat-based gestures, and qualitative findings. In terms of input modalities, study results indicate that touch gestures are preferred, voice gestures are avoided, and in-air gestures have lower agreement. The study also found that interaction constraints increase gesture agreement, and that tangible landmarks can inform potential touch gestures.

I described the design and implementation of three hat prototypes: a baseball cap, a fedora, and a flat cap. The hat prototypes are capable of sensing touch & head gestures, and include ambient displays of several types: a personal under-brim display, and a public crown display. The three prototypes were implemented to illustrate how the design concerns and gesture taxonomy could be applied to distinct hat form factors with varying affordances, inherent functions, and contexts of use.

I described an evaluation conducted with one of the hat prototypes. The evaluation consisted of two parts: gesture recognition of 8 gestures, and a task using the hat to control an external display. This evaluation had four aims: (1) to measure the accuracy of the sensing techniques; (2) to elicit user perceptions of proposed gestures; (3) to gauge thoughts and perceptions of hat technology more generally; (4) to garner initial feedback on the under-brim ambient display. A key finding from this study is that hat interfaces are desirable in specific

contexts, but not in general use. Finally, I discussed how future designs can be tailored to specific hat form factors in terms of *physical form*, *inherent functions*, and *contexts of use*.

A key focus of the work presented in this chapter was to assess various interaction modalities with regards to a particular form factor: hats. The next chapter takes a similar approach, exploring a new interaction modality for the skin —Lotion Interfaces. In contrast with previously explored interaction modalities for skin-based technologies, Lotion Interfaces are directly inspired by existing traditions and body practices. In particular, these chapters serve to illustrate how existing *usage patterns* and *social & cultural considerations* can inform and inspire *Heirloom Wearable* technology.

Chapter 8

Lotion Interfaces

A defining characteristic for all wearable technologies and many body-worn artifacts is *interaction modality*. Input can be active or passive, conscious or unconscious, subtle or performative. Interactions on the body can be inspired by existing body practices, or by legacy interactions with existing technologies. Figure 8.1 illustrates a two dimensional projection of potential skin-based interactions with regards to input type (active or passive) and the inspiration driving the interaction modality (body practices or existing technologies). The mapped interactions (e.g., biosensing, posture sensing, etc) were all explored in prior work on skin-based technologies, with the exception of Lotion Interaction, which is explored in this chapter. One way to determine if an active interaction modality is inspired by body practices or existing technologies is to consider whether the interaction might take place in the absence of wearable technology. As an example, people are unlikely to repeatedly tap or swipe the surface of their skin; thus, traditional touch gestures are inspired by legacy interactions with existing technologies rather than body practices. To determine if a passive interaction modality is inspired by body practices or existing technology, one should consider if the proposed form of input traditionally has an effect on the skin. Biosensing is inspired by body practices, as illness and internal conditions often manifest on the surface of the skin. Environmental sensing is inspired by body practices, as environmental conditions affect the appearance of the skin: increased sun exposure results in darkening of the skin, sometimes resulting in sunburn; increased exposure to smoke and other contaminants results in premature aging and other physical symptoms reflected on the surface of the skin. Alternatively, posture sensing is inspired by legacy interactions with existing technologies, particularly those that use gestural input.

This chapter explores a new interaction modality for skin-based technology directly inspired by existing traditions and body practices —Lotion Interfaces. In this chapter, I define Lotion Interfaces, present relevant design considerations, and introduce Lotio, an exemplar Lotion Interface. The chapter concludes with a preliminary user study conducted to understand perceptions and usage of lotion-mediated interaction.

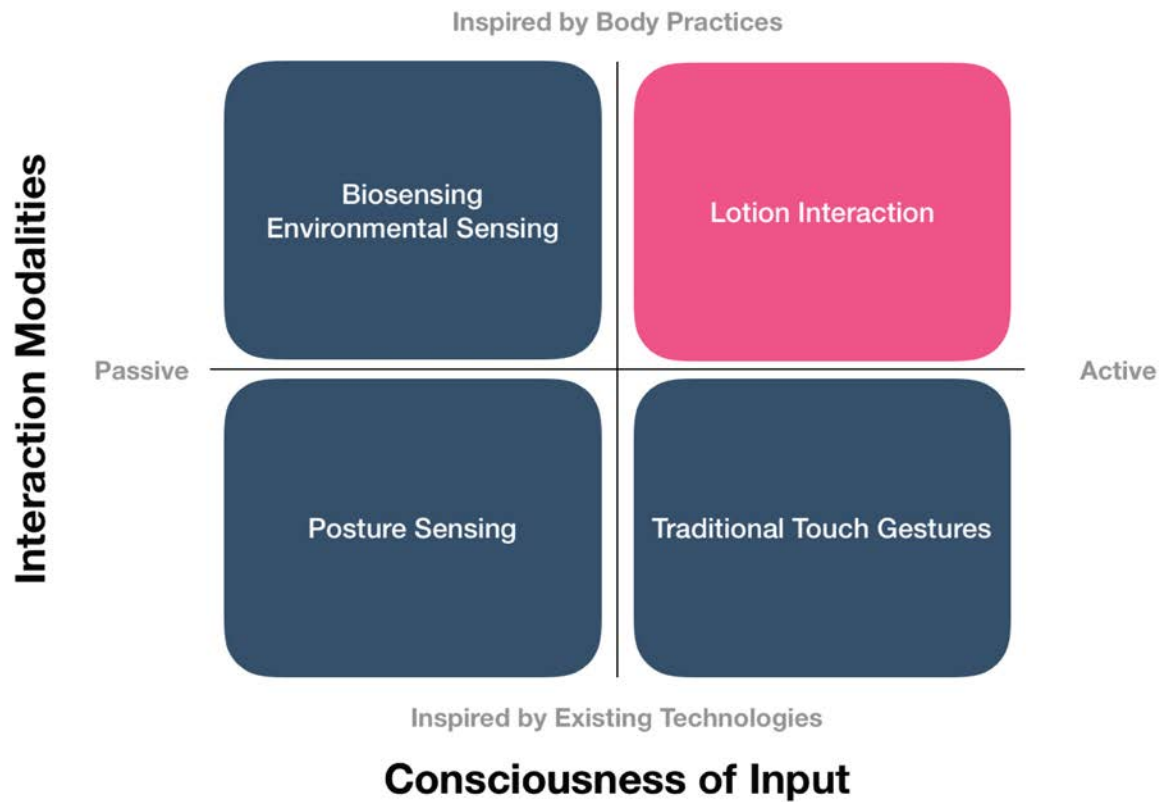

Figure 8.1: Interaction Modality (inspiration) and Consciousness (input) of various interactions leveraged by skin-worn wearable technologies. Interaction modalities implemented by prior work are shown in dark blue. Lotion-based interaction (shown in pink) occupies a unique location in the design space as an active form of input inspired by body practices.

8.1 Introduction

Lotions and creams exist in nearly all cultures throughout the world, dating back to around 23,000 BC [37]. They serve a variety of purposes including personal care, medicine delivery, body beautification, and protection from the elements. Once applied, lotions and creams seamlessly blend into the body, becoming indistinct from the wearer. The act of applying lotion is familiar, often habitual, and laden with cultural meaning. One’s past experiences inform a mental model of lotion as a transformative agent, able to alter the properties of the skin. This mental model of lotion, as all mental models, is constructed via perception [80]: makeups, tanning lotions, and certain medicinal creams (such as those for rosacea or acne) alter the aesthetic appearance; moisturizers and exfoliants alter the texture; applying sunscreen reduces susceptibility to UV exposure; applying hydrocortisone causes an itch to subside. Although knowledge around the body and lotion is tacit, humans have a rich

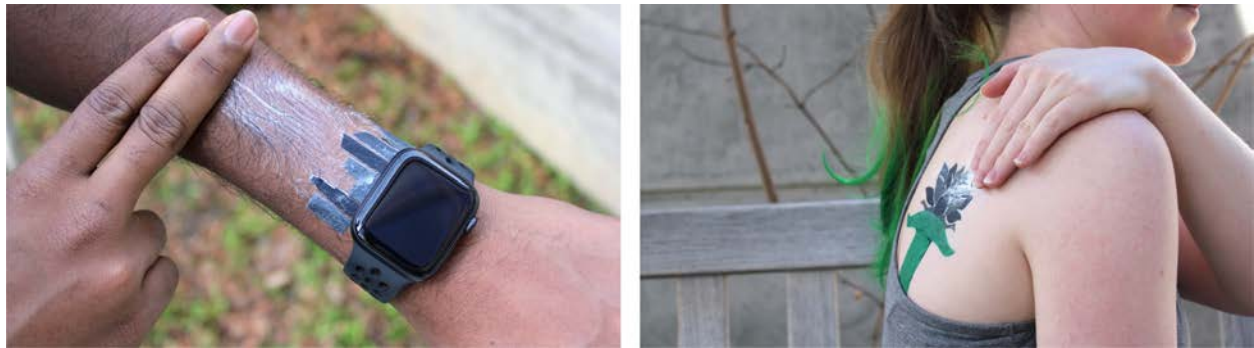

Figure 8.2: Lotion Interfaces sense and react to applied lotion. Left: “Skyscraper Skyline” prototype extends the display capabilities of a smartwatch onto the skin. Right: “Lotus Flower” prototype behaves as a fashionable form of personal expression.

implicit understanding of how lotions affect their skin.

While the affordances of lotion are underexplored, recent advances in materials and fabrication methods have enabled the creation of a wide range of skin-worn technologies. These interfaces on the surface of the skin provide new methods of always-available input [205], biomedical sensing [195], personal expression [115, 84], and beyond. I propose that introducing lotion as a mediator between the user and skin-based technologies can enable new forms of embodied interaction. To this end, I propose Lotion Interfaces: a novel interaction paradigm for on-skin technologies. The design takes inspiration from themes of cosmetic computing, beauty technology [193], hybrid body craft [83], and ubiquitous computing [207]. Viewing touch as an aesthetic experience [64, 104], Lotion Interfaces enable intimate interactions with technology that have different social and personal connotations from existing touch-based interactions.

Skin-based interfaces must be inclusive in their design, taking into account the full range of human skin types and color tones. Designs that are not inclusive across the rich diversity of skin types only serve to divide and exclude. Technologies should be celebrated as empowering and uniting individuals and society. I hope that the work presented in this chapter embodies this principle and sincerely expresses the desire to further the most inclusive designs possible while advancing the debate on technological equity, especially within HCI.

Lotion Interfaces

Lotion Interfaces are skin-worn interfaces that sense and respond to applied lotion. Lotion Interfaces are grounded in established mental models of lotions to enable embodied interaction with on-skin technologies [98]. The basic interaction model can be seen in across the top of Figure 8.3.

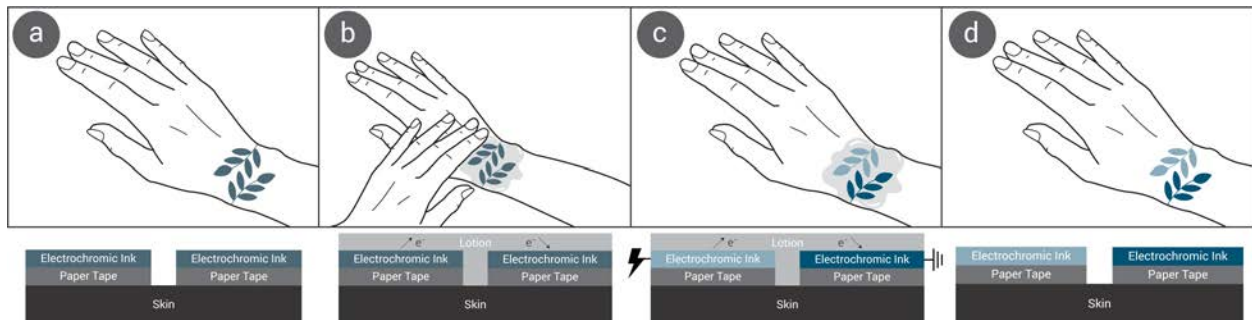

Figure 8.3: Interaction model for Lotion Interfaces. Lotio chemical and material architecture is shown below the stages of interaction. a) Lotio functions as a passive display in the dormant state, similar to a traditional temporary tattoo. b) The wearer applies lotion over top of Lotio. c) In response to the applied lotion, one portion of electrochromic ink is connected to power and the other is connected to ground. The applied lotion behaves as an electrolyte, allowing electrons to move from the positive electrode to the negative. The portion of the design connected to power is oxidised and becomes lighter in appearance; the portion of the design connected to ground is reduced and becomes darker in appearance. d) The lotion is absorbed into the skin. Electrons can no longer move between portions of electrochromic ink, and the new coloring is maintained even after power has been removed.

- (a) The user wears skin-worn technology. This technology may take the form of a wearable sticker, makeup, henna, a temporary tattoo, or a traditional tattoo, among others.
- (b) The user applies a lotion over the top of the skin-worn technology. Potential lotions include moisturizers, sunscreens, makeups, medicinal creams, and ointments, among others. While a diverse range of lotions, creams, and gels can be utilized, the lotion must be perceptible to the Lotion Interface, either through electrical or chemical properties.
- (c) The skin-worn technology senses the lotion and enacts some transformation. In Figure 8.3, the transformation is a physical change in visual appearance; however, the transformation may take other forms. Physical transformations may be visual (color, shape, etc) or tactile (texture). Transformations can also be digital, such as setting an alarm or changing the mode of a connected wearable device.
- (d) The lotion is absorbed, evaporated, or removed by the wearer. The transformation may persist beyond the interaction itself, as demonstrated by the bistability of the display in Figure 8.3.

In interactions with Lotion Interfaces, applied lotion acts as a mediator between the user and the on-skin technology [103].

Leveraging Semantic Priming and Mental Models

In addition to leveraging existing mental models of lotion, Lotion Interfaces enable semantic priming [123]. In cognitive psychology, priming is a phenomenon in which exposure to an initial stimulus affects the user’s response to a following stimulus. Semantic priming occurs when the two stimuli are semantically similar, increasing the accuracy or speed of responses to the subsequent stimulus. In Lotion Interfaces, the initial stimulus is the act of applying lotion, accompanied by tacit knowledge of the lotion, its connotations, typical uses, and past experiences: when a user applies a medicinal cream or ointment, they are intrinsically thinking about their health; when applying makeups, users are primed towards aesthetics. The subsequent stimulus is the transformation enacted by the Lotion Interface. Semantically linking these two stimuli can enable more meaningful interactions with and more intuitive interpretations of skin-worn technologies. For instance, displaying UV exposure data when sunscreen is applied or communicating body temperature in response to an antibiotic ointment. Furthermore, displaying health data on the skin can lend a corporeality to the data, making it more salient to the user [10].

Foregrounding existing mental models of lotion and using them for semantic priming, Lotion Interfaces enable new possibilities for interaction with skin-based technologies. These interactions are easily integrated with existing wearable technologies since many conventional lotions and creams are electrically conductive and lend themselves towards well established sensing methods [159]. I position Lotion Interfaces as a novel interaction paradigm for skin-based electronics. As an exemplar Lotion Interface, I present Lotio: a lotion-reactive, computationally-controllable electrochromic display. The design has taken care to use lotions and creams that are commonly used in many cultures throughout the world, and is deliberate in presenting a skin-worn display that is visible on varying skin tones. Lotio represents just one of many possible embodiments of Lotion Interfaces. I report on findings from a qualitative exploratory study with nine participants of the Lotio prototype. Finally, I detail a range of practical and playful applications for Lotion Interfaces.

8.2 Related Work

Recent research in HCI has shown that the skin provides a unique substrate for wearable electronics [85, 115, 119, 135, 201, 205, 206]. These technologies are inspired and enabled by materials research into epidermal electronics [60, 93]. Prior work has explored wearable technology in the form of silicone overlays [201, 205, 209], temporary tattoos [85, 115, 206], and electronic bandages [119]. Some of these interfaces have sensing capabilities, others have built-in displays; however, many on-skin interfaces explore both input and display on the surface of the skin.

Input on the Skin

Existing skin-worn interfaces use capacitive sensing [85, 115, 201, 205, 206, 209, 135], resistive sensing [115, 205], bend sensing with strain gauges [115, 206], and sensing via embedded sensors [119]. These sensing techniques equip the user with new forms of always available input, and enable novel types of body engagement such as posture sensing [115] and wound monitoring [119]. Lotion Interfaces proposes to expand the input space of on-skin technologies with lotion-mediated interactions. Because lotion can be sensed and identified using capacitive or resistive sensing, existing technologies that use these sensing methods can easily be patched to support this new class of interactions.

Skin-Worn Displays

Prior work has placed LEDs [115, 119], thermochromic pigments [85, 201], and electroluminescent (EL) displays [206, 209] on the surface of the skin. These display techniques have different advantages and design considerations. LEDs and EL displays are emissive displays with fast response rates; whereas, thermochromic displays are non-emissive and change more gradually. Furthermore, these display types have different power requirements and are suited for different applications. Together, these works showcase a compelling design space for on-skin displays. Lotio contributes a new material to this design space: electrochromic ink. Non-emissive with a variable response rate, this material complements the existing design space. A key distinction over prior skin worn displays is the low-power nature of the material. Although EL displays (such as those used in [206, 209]) draw low-current, they require high voltage. Lotio displays can be driven at 0.5V and less than 1mA. Lotio displays also exhibit bistability. This feature distinguishes this work from prior work and enables new opportunities for on-skin interaction.

Epidermal Electronics

Preceding skin-worn interfaces in the field of HCI, Epidermal Electronics originated in the field of Materials Science [93]. Functionally, Lotion Interfaces behave similarly to epidermal interfaces that monitor skin hydration [75, 100, 28, 74, 222]. As discussed later in the chapter, Lotio uses PEDOT:PSS as the active material. The use of PEDOT:PSS in epidermal electrochromic displays has been explored in the fields of Materials Science and Chemical Engineering [140, 20]. Lotion Interfaces expand existing epidermal electronics with a new interaction paradigm and a DIY methodology.

8.3 Design Considerations

Lotion Interfaces cover a unique design space; they have different limitations and opportunities than other wearable devices, even those worn on the skin. Here, I outline several design

considerations for Lotion Interfaces. These considerations were drawn from the literature and my personal experience with lotion and designing wearable devices.

A New Physicality

The first generation of wearables have taken existing form factors (i.e., flat, rigid glass screens) and interaction styles (i.e., touchscreens) and simply placed them on or adjacent to the body (i.e., smartwatches). Recent advances in HCI and beyond have explored soft, deformable, and foldable interfaces, enabling new ways to integrate technology with the body [163, 106, 53]. Lotion Interfaces is yet another evolution in this wearable landscape as the interaction and materiality transitions towards lotions, creams, and topical skin gels (*physicality*).

This new physicality enables a broader range of potential interactions with technology on the body. The intimate act of applying a lotion is aesthetically distinct from tapping a screen, stroking a fabric, or even existing touch interactions with skin-worn interfaces. However, this new physicality requires additional consideration. Appropriate locations on the body and contexts of use must be carefully reexamined through this new lens.

Design for Temporality

Unlike other interactive materials, lotion is transient in nature—it absorbs and evaporates. In addition to enabling novel interactions, this characteristic of lotion comes with unique constraints. I detail a few of these here.

Infrequent Interactions

Designers of Lotion Interfaces must take special care when considering desired frequency of interactions. While a user might feasibly interact with a smartwatch 20 times within a single hour, it is much less likely for that user to apply lotion to a skin interface at a similar frequency. To address this, Lotion Interfaces should support infrequent interactions (*usage patterns*). Alternatively, Lotion Interfaces can support multiple input modalities: infrequent lotion-mediated interaction as well as unmediated touch input [115, 85, 206].

Allow Absorption

A universal characteristic of lotion is its ability to be absorbed into the skin (*removability*). It is exactly this characteristic that gives lotion its transient nature. Lotion Interfaces should preserve this attribute. While Lotion Interfaces can take many different forms, the chosen substrate should be thin and breathable to allow applied lotion to absorb into the skin. Temporary tattoos [115, 135, 206], gold metal leaf [85], and silicone [89, 202, 201, 205, 209] are insulating and thus hinder this characteristic of lotion usage. Alternatively, traditional tattoos [195], powders [86], and bandages [119] enable lotion absorption through the interface.

Transform the Skin

Lotion Interfaces engage existing mental models of lotion as a transformative agent. Designers of Lotion Interfaces should leverage this in accompanying lotion input with some clearly perceptible output (*mutability*). These outputs will be most effective when at the same location as the lotion application —directly on the skin. Co-locating input and output on the surface of the skin will facilitate interactions that parallel traditional lotion usage (*usage patterns*). Many existing skin-worn interfaces that co-locate touch input with dynamic displays on the surface of the skin satisfy this design consideration [115, 85, 206].

Tie Functionality to Lotion Type

Designers of Lotion Interfaces should enable semantic priming by tying functionality to lotion type. This can be achieved through designing a Lotion Interface with limited functionality that responds to a single type of lotion: for instance, a UV monitor that reacts to sunscreen. Alternatively, this can be achieved through designing a more complex Lotion Interface with multiple functionalities enacted through differing lotion types.

Selam has a face-worn Lotion Interface. As she's leaving her place to attend her sister's birthday brunch, she applies foundation to her face. Sensing the applied makeup, the Lotion Interface causes her lips to redden and her cheeks to blush [84, 86]. Upon arriving home, she begins to feel a tingling on her upper lip and fears a cold sore may be coming on. She rifles through her medicine cabinet for a topical cold sore remedy, and applies it. Sensing the applied medication, Selam's face-worn Lotion Interface begins monitoring her skin for biomarkers of infection [142, 221].

Account for Diversity of Skin

Lotion Interfaces must be inclusive in their design, taking into account the full range of human skin types and color tones. Skin-worn displays must be visible on a range of skin tones. Changes in texture [89] must be compatible on a variety of skin types [9]. Furthermore, Lotion Interfaces should account for cultural considerations in lotion type (*social & cultural considerations*). Wherever possible, designers should use lotions and creams that are universally available, or allow interfaces to be tailored for individual use.

Allow for Personalization

While all wearable devices need to be accommodating to the wearer's personal style and cultural considerations, skin-worn technologies have additional requirements. As part of the body, skin is inherently personal. In addition, there exists a rich cultural history of skin adornment. Tattoos, henna, overlays, and makeups are all employed to change the appearance of skin, often for personal expression. These existing practices have varying



Figure 8.4: Lotio is a dynamic overlay worn on the skin. When lotion is applied, Lotio functions as a computationally-controllable segmented display, with some portions of the design becoming more saturated and darker in appearance, and other portions of the design becoming less saturated and lighter in appearance. Left: Cosmetic “Eyeliner” prototype. Middle: “Lotus Flower” prototype as a public-facing display. Right: “Skyscraper Skyline” prototype as an extension to existing wearables.

permanence and are highly dependent on the individual. While Lotion Interfaces can vary from temporary to permanent, they should allow for personalization in terms of aesthetics in order to match the cultural considerations and personal style of the user (*customizability*). Depending on aesthetics and location on the body, Lotion Interfaces can range from hidden to highly visible, subtle to spectacular (*aesthetics*).

8.4 Lotio

Design recommendations are only useful if they can be enacted in real designs. To operationalize these recommendations, Lotio was designed and created as an exemplar Lotion Interface. Lotio is a dynamic overlay worn on the skin that resembles a temporary tattoo (See Figure 8.4). Lotio foregrounds the interactive nature of lotion and augments the user with new interaction capabilities and forms of personal expression. When lotion is present, Lotio functions as a computationally-controllable bistable segmented display (See Figure 8.3). In addition, Lotio uses capacitive sensing to detect when lotion is applied, and to sense characteristics of the interaction, such as the type and amount of lotion applied. Here, I present a use case scenario to illustrate the interaction capabilities of Lotio:

Julio is playing tennis with his neighbor Maria. Feeling the sun beating down, he reaches for his sunscreen between matches. He liberally applies sunscreen to the exposed portions of his arms, covering the Lotio overlay on his forearm. Sensing

this interaction, Lotio pulls UV exposure data from Julio’s Apple Watch. Julio’s Lotio overlay updates, indicating his UV exposure and frequency of sunscreen application. Noticing that his UV exposure is higher than it has been all week, Julio suggests they break for the day.

As discussed previously, Lotion Interfaces leverage existing mental models that position lotion as a transformative agent. Lotio enables physical transformations through the lotion-dependent dynamic display, as well as digital transformations through its ability to sense lotion-mediated interactions and subsequently modify its functionality, or communicate with external devices. The bistable nature of the display and memory of the attached microcontroller allows for these transformations to persist beyond the interaction itself. Furthermore, Julio’s interaction with UV exposure data demonstrates how semantic priming can be used to sculpt meaningful and intuitive interactions with Lotion Interfaces. Lotio represents just one of many possible embodiments of Lotion Interfaces.

Materials

Electrochromic Ink

The electrochromic ink used in the Lotio prototype is poly(3,4-ethylenedioxythiophene) polystyrene sulfonate (PEDOT:PSS). Key properties of this material are electrochromism and high conductivity. PEDOT:PSS is commonly used in electrochromic displays, both commercially available¹ and in research [79, 3]. These electrochromic displays use PEDOT:PSS as an electrochromic material, but don’t use PEDOT:PSS as a conductive material, opting for ITO or other materials as an electrode. Conversely, other prototypes and products use PEDOT:PSS as a conductor, but ignore the electrochromism of the material. For instance, several on-skin interfaces use PEDOT:PSS as their conductive layer, but use electroluminescent material as a display material [206, 209], or other forms of output [215]. Additionally, PEDOT:PSS is frequently used as a transparent electrode in flexible organic electronic devices such as LEDs [97], solar cells [52], and epidermal electronics [197]. PEDOT:PSS is particularly well suited to applications on the skin because it is stretchable [112]. Lotio’s implementation utilizes both the electrochromism and conductivity of PEDOT:PSS. As such, the design does not need separate layers for conductivity and display.

Substrate

Lotio uses paper surgical tape² as a substrate for the electrochromic ink. This material is commonly used in medical applications to secure a bandage to a wound. Paper tape conforms to the skin, allowing for seamless body integration and comfortable wear. In addition, this material is breathable and allows for lotions to absorb into the skin, enabling temporal

¹<https://www.ynvisible.com/>

²3M™ Micropore™ Surgical Tape, 3m.com



Figure 8.5: The fabrication process for Lotio. a) Design electrode shape and layout interconnects. b) Cut the substrate using commercial vinyl cutter. In this case, the paper tape substrate was applied to waxy paper before cutting. c) Remove excess substrate so that only the design remains. d) Apply electrochromic ink to the cut substrate. e) Transfer resulting design using transfer tape to the skin.

interactions with lotion. To remove Lotio, the paper tape is simply peeled off the skin, similar to removing a band-aid.

Lotion

Many lotions and creams are inherently electrically conductive and therefore compatible with Lotio without need for modification. Thus, all of the lotions and creams used are commercially available and commonplace. The presented implementation uses sunscreen, aloe vera, and moisturizer; however, there are many other lotions and creams that are electrically conductive and suitable for Lotion Interfaces.

Fabrication

Lotio is easy and affordable to produce using commercially available materials and a DIY methodology. Furthermore, the aesthetic design of Lotio is highly customizable, and can be tailored to fit the wearer's personal style. The substrate (e.g., paper tape) is die cut to the desired shape (See Figure 8.5, a & b). This allows for detailed designs with a high level of precision. Next, the substrate is dyed with electrochromic ink (See Figure 8.5, d). Prior work details methodology for ink-jet printing and screen printing [79]; however, since the substrate is cut in the same shape as the design, a brayer can be used to coat the tape in electrochromic ink. Finally, transfer tape is used to apply the design to the skin (See Figure 8.5, e). Lotio is approximately 0.15mm thick, and supports multi-layer designs as well as the addition of art overlays (See Figure 8.4, center).

Technical Implementation

Utilizing electrochromic ink, Lotio operates in a similar fashion to traditional electrochromic displays [3, 79, 132]. Lotio relies on a voltage differential between disjoint portions of elec-

trochromic ink that function as electrodes. Leads connect at least one electrode to ground and another to power. Applied lotion behaves as an electrolyte, allowing electrons to move from the positive electrodes to the negative. The portion of the design connected to power is oxidised and becomes lighter in appearance; the portion of the design connected to ground is reduced and becomes darker in appearance. Because electrons require an electrolyte (e.g., lotion) to move between disjoint portions of electrochromic ink, Lotio is bistable. When the lotion is absorbed, evaporated, or removed, the design is fixed and will no longer change visual appearance. Thus, visual changes in saturation can be maintained without the need for continuous power. See Figure 8.3, bottom, for an illustration of system architecture during the stages of interaction and Figures 8.9 & 8.6, left, for resulting visual outputs.

Lotio enables input in the form of capacitive sensing: segmented portions of the design serve as electrodes and can function as buttons, sliders, and other interactive elements. Furthermore, Lotio can use established techniques (e.g., Swept Frequency Capacitive Sensing) to detect the presence of various lotions and creams [159]. Using Swept Frequency Capacitive Sensing (SFCS), the system can distinguish whether or not lotion is present, determining whether the user is acting alone, or in collaboration with lotion. Lotio can also use SFCS to distinguish between lotions with varying conductance and determine the amount of lotion present. Designers can tailor interactions and functionalities depending on the lotion applied.

As mentioned, the ink is both electrochromic and conductive. Leveraging this, Lotio combines input and output in a single layer of the design. This layer is highly customizable and aesthetic. Lotio expands prior works that utilize conductive traces as an aesthetic element of the design by integrating display capabilities [114, 85]. Lotio prototypes are controlled using an Arduino Uno with connected BLE module; however, I envision Lotio to be powered and controlled by lightweight wearable devices such as a smartwatch or electronic bracelet (See Figure 8.2, left). Finally, Lotio is low-power and safe to wear on the skin. Lotio consumes less than 1mA while switching the display, and functions passively during capacitive touch sensing. This is considered physiologically safe for humans [160].

Design Parameters

Switching Rate

The switching rate refers to how long it takes the negative electrodes to reach maximum saturation once lotion and voltage have been applied. The switching rate is dependent on the conductivity of the electrodes. Designers can influence switching time through varying the number of layers of electrochromic ink, the resistance of the design, and the amount of voltage applied. The prototype used in the user study (See Figure 8.8) has a switching time of approximately 4 seconds at 1V, 1 second at 3.3V, and 250 milliseconds at 10V (See Figure 8.6, right). This prototype has 7 layers of electrochromic ink, and an average electrode resistance of 2k Ohms. Electrode resistance refers to the resistance between the dynamic portion of the display and it's respective lead. Designers can decrease switching time with

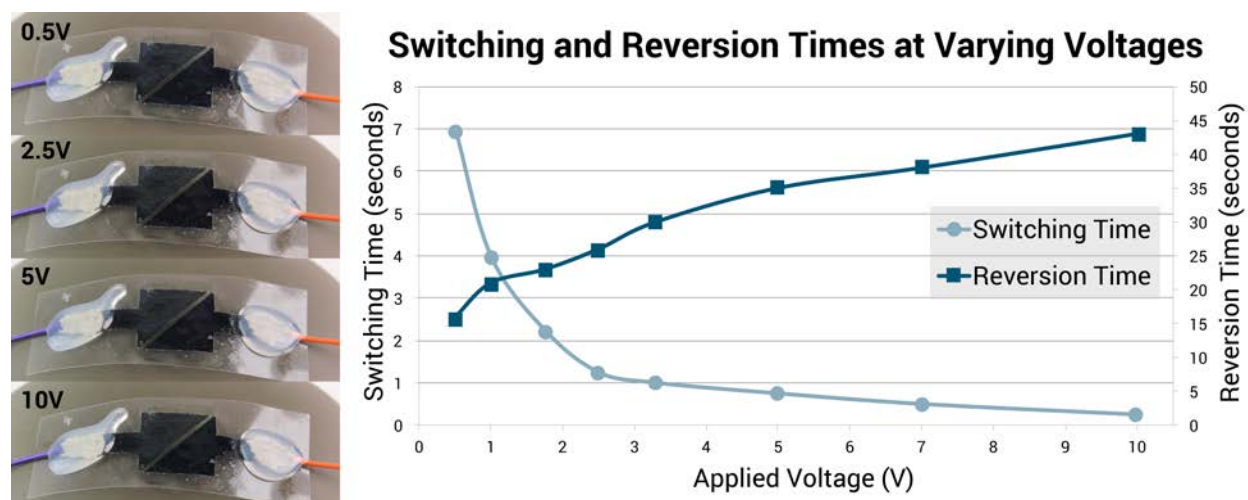

Figure 8.6: Left: Visual clarity of user study prototype at 0.5v, 2.5v, 5v, and 10v. There is minimal perceptible difference between varying voltages. Right: Switching and reversion rates (in seconds) of the user study prototype at differing voltages between 0.5v and 10v.

additional layers of electrochromic ink, lower design resistance, or increased applied voltage. Conversely, designers can increase switching time with fewer layers of electrochromic ink, higher design resistance (see resistive heating circuits in prior work [85, 201]), and decreased applied voltage.

Reversion Rate

The reversion rate refers to how long it takes for Lotio to return to its original appearance with equal saturation between all electrodes. This occurs when voltage is removed but the lotion remains. The reversion rate of Lotio is dependent on the amount of voltage that was applied. The prototype used in the user study has a reversion rate of approximately 21 seconds at 1V, 30 seconds at 3.3V, and 43 seconds at 10V (See Figure 8.6). Because electrochromic ink requires an electrolyte to change visual appearance, Lotio is bistable and will not revert if lotion isn't present.

Visual Clarity

Visual clarity refers to the visual variance between positive and negative electrodes once lotion and voltage have been applied. Visual clarity depends on the density of electrochromic ink. Designers can influence visual clarity by modifying the number of layers of electrochromic ink (See Figure 8.7). Varying voltage has little to no effect on resulting visual clarity (See Figure 8.6, left).

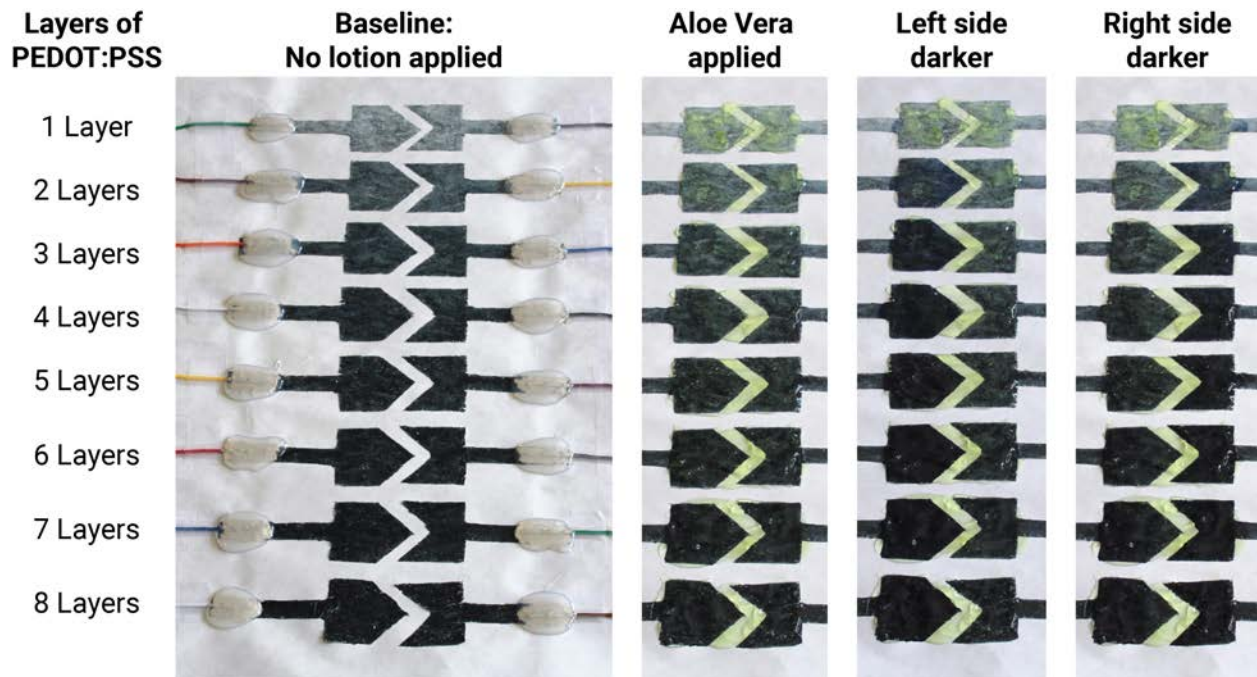

Figure 8.7: Visual clarity of Lotio prototypes with varying densities of PEDOT:PSS. From left to right: (1) baseline visual appearance of Lotio prototypes with no lotion applied; (2) appearance of Lotio prototypes after Aloe Vera has been applied; (3) the left side of each prototype is grounded (the PEDOT:PSS is reduced and becomes darker in appearance); (4) the right side of each prototype is grounded. From top to bottom, 1 layer of PEDOT:PSS to 8 layers of PEDOT:PSS.

8.5 Preliminary User Study

I will now present results from a preliminary user study with nine participants interacting with the Lotio prototype to understand perceptions and usage of lotion-mediated interactions. This user study was reviewed and approved by UC Berkeley’s Institutional Review Board (IRB).

Participants And Procedure

Participants ranged in age from 19 to 41 years old (avg. 24.9 years). 5 participants identified as women, 3 participants identified as men, and 1 chose not to specify. Participants were recruited from local university mailing lists and invited to a studio location for the hour-long study. They were compensated at the rate of \$20/hour.

First, lotion was applied to Lotio on a white backing (See Figure 8.8, right) and participants were asked to describe any visual changes they noticed. Then, the display was

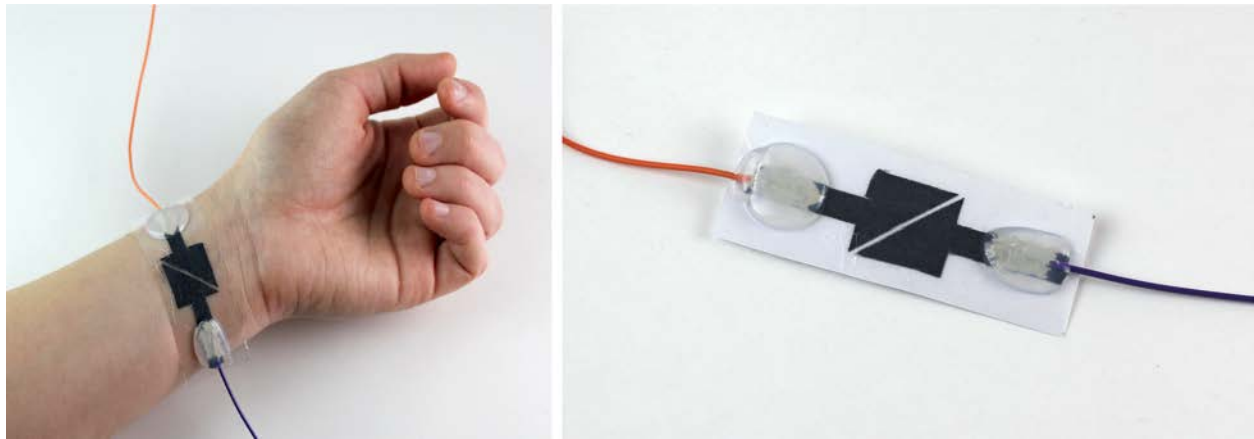

Figure 8.8: The prototype used during the user study. Lotio was adhered to an adhesive plastic substrate for simplified application and removal during the user study. Left: the user study prototype being worn. Right: the user study prototype on a white backing. In both images, no lotion has been applied.

toggled 2 or 3 times so participants could become familiar with the visual appearance. After becoming familiar with the visual characteristics of the display, participants were invited to wear the prototype on a body location of their choosing (See Figure 8.8, left). All participants opted to try out the prototype. During the user study, the prototype was actuated at 5V. Finally, the study concluded with a semi-structured interview to garner thoughts and reactions to the presented prototype and interaction. All interview meetings were audio recorded, transcribed, and analyzed, following best practices for a qualitative interview [208].

Findings

The way it changed the shade and the saturation, the density of the ink, like right before my eyes and on my skin it felt really interesting (P1).

After users became familiar with the two device states on their own skin, the actuation was toggled back and forth. Participants responded favorably to the ebb and flow of the design.

It also seemed almost like it was breathing or alive (P1).

Participants' Envisioned Usage

When invited to wear the designed prototype, participants wore Lotio on on the back of their hand, the inside of their wrist, the back of their forearm, and the inside of their forearm.

All participants thought that the forearm, wrist, and hand were ideal locations for skin-worn technology. This finding echoes prior work on appropriate locations for skin-worn technologies [62]. In addition, four participants envisioned wearing the interface on the face or neck. In deciding appropriate locations for Lotion Interfaces, participants were concerned with visibility (P2, P3, P6; *aesthetics*), accessibility (P2, P4, P7; *physicality*), and existing cosmetic practices (P3, P4, P6; *usage patterns*).

Seven participants envisioned using Lotio for health monitoring and medical applications. Participants were interested in measuring sweat (P5), body temperature (P3, P5), and UV exposure (P2). In addition to sensing, participants imagined using Lotio to display health data sensed on other devices. This data included blood sugar levels (P3, P9), heart rate (P3, P5, P9), and hydration level (P6). P6 thought that a Lotion Interface would be particularly well suited to “surfacing relevant body data” because “the act of applying lotion itself could be seen as a self-care activity”.

Participants envisioned using Lotio for aesthetics, notifications, and as an input for smartphones, smartwatches, and other devices. P8 imagined using Lotio for “anti-facial recognition”. P6 considered using Lotio as a “protest object” for “social activism”. Two participants wanted to use Lotio as a form of nonverbal communication, “reflecting emotions” and behaving as a “subtle social cue” (P6). These participants also considered what it would mean to “wear it socially” (P5), envisioning “an emotional network where peoples’ [Lotion Interfaces] change the same way certain times” (P6). It is encouraging that participants responded favorably to lotion-mediated interaction and were able to visualize a broad range of potential use cases. Here I detail a few themes that emerged through conversations with participants.

Abstract / Representational

Participants disagreed over whether the design should be abstract or representational. Some participants wanted the design of the interface to be tied to the functionality.

I don’t think I’m a fan of this particular imagery because I don’t think the imagery means anything (P3).

Other participants preferred abstract visualizations.

The aesthetics are very mysterious. There’s no denotative information on it, which I like (P2).

Many participants expressed a desire for flexibility, allowing the user to easily design or modify the aesthetics to match their personal tastes (*customizability*).

Public / Private

Some participants considered Lotio’s audience, determining where to wear the interface to facilitate different types of interactions.

[I would wear Lotio] somewhere where not everyone can see it, so it's more of a private informative piece that I can reveal important information about my body to myself (P6).

It could be a signal to other people too, if I wore it on some other place where I couldn't see it but other people could (P5).

These participants also identified ways in which the interface could be concealed and revealed, such as with a sleeve.

Body Integration

Participants liked that the interface attached directly to the skin and likened it to an extension of self.

It's fundamentally different because it feels like it's sort of becoming one with your body instead of just an external device that is registering things about your body (P2).

It's like just adding on to your skin (P3).

Five participants desired further body integration, envisioning more “permanent” and “seamless” embodiment (*physicality*).

I would actually like if it's a permanent tattoo and it was just there 'cause that lowers the fact that I have to put it on everyday. If it's there all the time it's better 'cause then I don't have to wear it (P5).

Several participants found the concept of lotion-mediated interaction “seamless” and imagined incorporating Lotio into their daily cosmetic routines: “styling” it each morning as one would their hair or makeup. While this preliminary user study provided initial insights into lotion-mediated interaction, further evaluations are necessary to assess and contextualize this new interaction paradigm.

8.6 Envisioned Applications

I present here a selection of proposed use cases for Lotion Interfaces. These interactions are inspired by conversations with user study participants, as well as my experience designing Lotio and other on-body technologies.

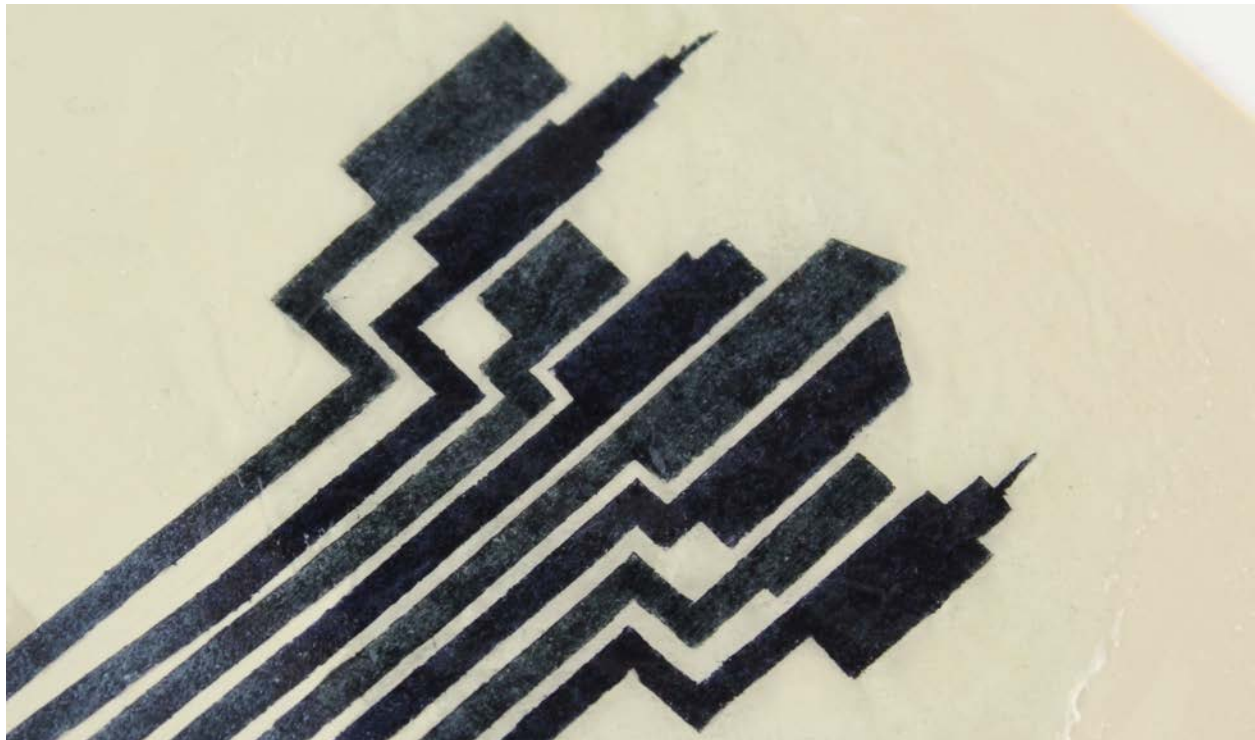

Figure 8.9: Skyscraper Skyline prototype. Every other “building” is actuated and darker in appearance.

Personal Health Monitoring

The semantic priming enabled through Lotion Interfaces makes them especially effective for displaying personal health data. Sensing applied moisturizer, a Lotion Interface may pull hydration metrics from the user’s smartphone and display them on the skin. Sensing applied Valerian oil³, the same Lotion Interface may instead pull biosignals related to stress from a connected wearable device. In either case, the data is displayed directly on the skin, leveraging mental models of *lotion as a transformative agent*. Lotion Interfaces can also be used to track habits associated with the skin: for instance, monitoring the frequency of sunscreen application. In addition to sensing when sunscreen has been applied, the Lotion Interface can display frequency information at the time of application. Furthermore, Lotion Interfaces themselves can be designed with embedded sensors capable of health monitoring, reducing reliance on external devices.

³Valerian oil is commonly used as an herbal remedy to promote sleep and calm anxiety [68].

Dynamic and Temporal User Interfaces

Similar to existing on-skin technologies [85, 115, 201, 205, 209], Lotion Interfaces can be used as an input to external devices. Wearers can use the interface to play/pause music that they're listening to, answer phone calls, or control an external display. Lotion Interfaces can sense touch input both with and without lotion present, able to differentiate between the two states. This adds an additional modality to on-skin interactions. For instance, applying a therapeutic or restorative lotion could cause a connected music player to transition to a soothing and relaxing playlist whereas touch interactions without the presence of lotion may simply toggle between songs of a similar genre. Furthermore, the presence of lotion can add a temporality to skin-based interactions. A user can apply lotion when they need a UI interface. Once the interaction is complete and the lotion is absorbed or removed, the Lotion Interface reverts back to a static display.

Kouki is washing his dog when his phone begins to ring. Sensing his soaking wet pug's eagerness to escape bath-time, Kouki doesn't chance retrieving his phone from the other side of the bathroom. Instead, he grabs his shower gel from the side of the tub and spreads some over the Lotion Interface on his bicep. Activated by the applied gel, Kouki's Lotion Interface now behaves as a controller for his mobile device. He touches one portion of the design to answer the phone call, and a second portion of the design to enable speakerphone. Kouki catches up with his brother as he continues to wash his pug. After hanging up, Kouki uses a washcloth to wipe away the shower gel on his bicep. His Lotion Interface reverts back to a static display.

Dynamic Personal Expression

Lotion Interfaces can be used for dynamic personal expression. A Lotion Interface could be worn on the face as a form of dynamic makeup. Applying lotion to this interface may cause the makeup to transition from day to night, with material around the eyes darkening for a more dramatic look (See Figure 8.4, left, for an example of a cosmetic Lotion Interface). I also envision Lotion Interfaces being used in playful, performative, and abstract manners. For instance, Lotion Interfaces could embody a connected data stream. When the wearer applies lotion to their Lotion Interface, the interface pulls data from the stream and updates the visual display accordingly. The concrete values of the data may be unknown to the wearer, who simply experiences the abstract and aesthetic nature of their changing Lotion Interface (See Figure 8.10). In this scenario, data inhabits physical space on the surface of the wearer's body as a form of "vibrant matter" [10]. Participants in the user study were particularly drawn to Lotio *as* it was changing. Inspired by participants' fascination, Lotion Interfaces could be used as an animated skin display. After the lotion is applied, but before it is absorbed, the display elements could ebb and flow, fluctuating randomly or in a pattern.

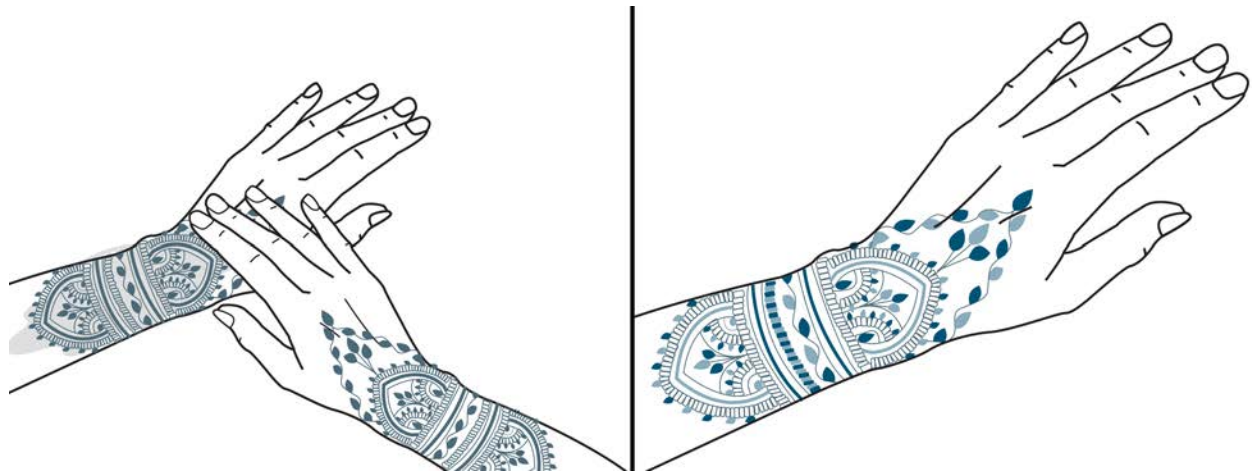

Figure 8.10: Henna-inspired embodied data stream. The weekend following her wedding ceremony, Payal admires the henna-based Lotion Interface still visible on her forearms and hands. Applying an essential oil made from rose petals, Payal notices the visual appearance of her Lotion Interface begin to ebb, with portions becoming darker in appearance and other portions becoming lighter in appearance. Payal knows that the visual appearance of her Lotion Interface is tied to the use of her wedding hashtag online, but has no way to concretely interpret the visualization. She appreciates the dynamic nature of the interface, and feels delight in thinking about all of her family and friends that were able to attend the celebration.

8.7 Discussion

Design Considerations Revisited

Conversations with participants in the user study revealed new insights into the design considerations. I revisit a few of the considerations here.

A New Physicality

Participants' concerns when assessing appropriate body locations highlight the new physicality of Lotion Interfaces. While visibility and accessibility are concerns universal to all wearable devices, participants paid particular attention to existing cosmetic practices and appropriate contexts of lotion use. Adopting established usage patterns of lotion, many participants considered the face and neck as appropriate locations for lotion-driven technology, and imagined interactions that closely parallel traditional cosmetic usage. These special considerations highlight the new design space for Lotion Interfaces.

Design for Temporality

Lotio was applied to an adhesive plastic substrate for simplified application and removal during the user study (See Figure 8.8). This plastic substrate was insulating, and inhibited the applied lotion from absorbing into the skin. Participants responded negatively towards this, finding it unnatural and in opposition to prior experiences with lotion.

I didn't feel the lotion on my skin itself 'cause it was on the sticker, so I felt like there was a lack of interaction with the lotion itself on my skin which is the feeling that I usually get when I use lotion (P6).

It sort of felt similar to just applying [lotion] onto my skin but without it absorbing into my skin (P7).

The negative reaction of participants highlights the need for Lotion Interfaces to *allow absorption*.

Allow for Personalization

Participants disagreed over whether Lotion Interfaces should be abstract or representational, public or private. In addition, some participants had conflicting thoughts on what were appropriate locations for Lotion Interfaces. While not specific to Lotion Interfaces, these diverging outlooks highlight the need for flexibility in wearable devices (*customizability*).

Skin Tone Variance

The design of Lotio took extra care to ensure that prototypes would be visible on a range of skin tones. In addition to probing thoughts and perceptions of lotion-mediated interaction, the user study assessed visibility on three mannequin heads of varying skin tones (See Figure 8.11). For each mannequin head, the prototype was placed on the forehead, lotion was applied, and the prototype began to change. Participants were asked to identify which portion of the design was darker/more saturated, and to rate the noticeability. The order in which the skin tones were presented was counter-balanced; the actuated portion of the design was randomized.

Participants were asked to rate noticeability on a seven-point semantically anchored Likert scale (1 = Not noticeable at all, 7 = Very Noticeable). Participants ratings can be seen in Figure 8.12. Participants found the prototype to be relatively noticeable without major differences between the three skin tones. Participants found the visual changes most noticeable on the lightest skin tone and least noticeable on the middle skin tone. The study also measured the amount of time it took participants to verbally indicate the more saturated portion of the design. Across all skin tones, participants took an average of 5.4 ± 1.8 seconds. Despite the lightest skin tone having the highest visibility ranking, the darkest skin tone had the quickest response rate (4.9 ± 1.2). Rankings of noticeability may have been biased based



Figure 8.11: Mannequin heads used during the user study to assess visibility on varying skin tones.

on expectations of visibility. One participant was perplexed when they found the prototype to be the most visible on the darkest skin tone.

That's odd. I don't know if it's a function of the color of the skin or the darkness of the skin (P5).

While these initial results are promising, additional work must be conducted to further assess functionality on varying skin tones and types. Towards this goal, future prototypes will be assessed on real skin, rather than mannequins.

Ambient Displays

Data displayed on the skin can be abstract or representational, emissive [206] or non-emissive [115], eye-catching or more subtle. While Lotion Interfaces can be any of the above, they are particularly well suited to ambient displays. The wearer does not need to dedicate subconscious attention to monitoring their skin-worn display for visual changes, because they know it will only change when lotion is applied. At this point, the user is already subconsciously thinking about their skin, and is primed to notice changes in its visual appearance. Ambient Lotion Interfaces such as Lotio contribute to the growing body of work examining the potential for ambient displays on the body [38, 69].

Noticeability Rankings of Varying Skin Tones

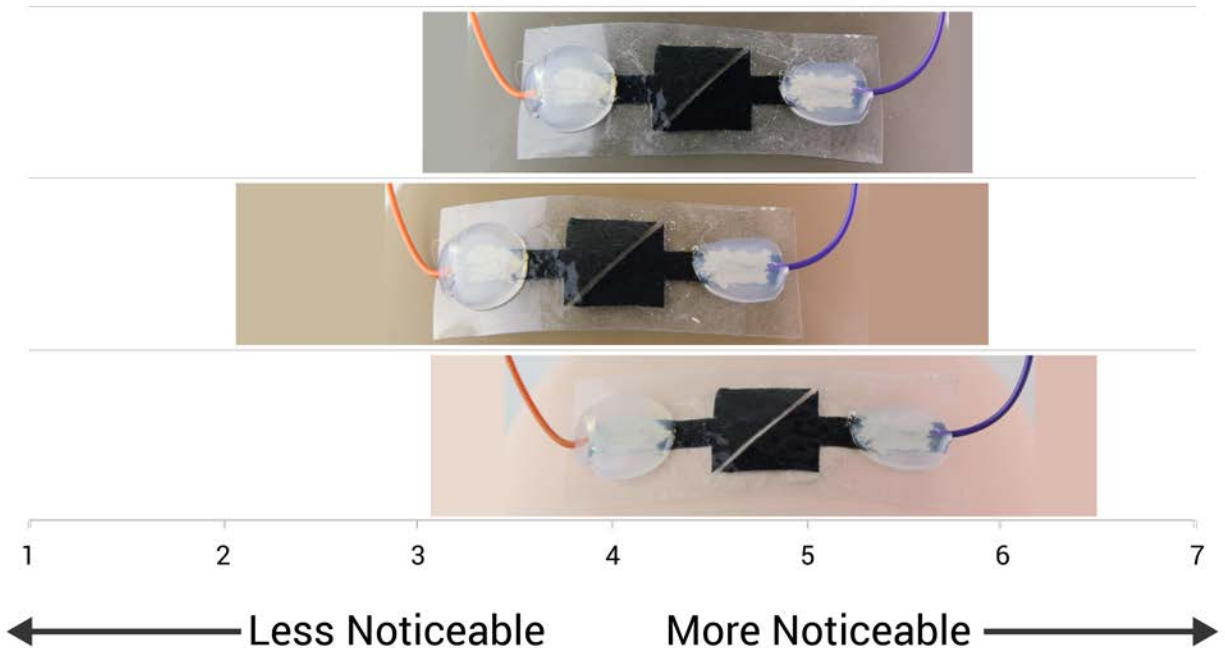

Figure 8.12: Participants' noticeability ratings of varying skin tones (1 = Not noticeable at all, 7 = Very Noticeable). The center of each image (where the dynamic portion is) represents the average noticeability ranking for that skin tone; the width of each image represents the standard deviation. In each of the images, the bottom right portion of the design is darker.

Lotion-Less Interactions with Lotion Interfaces

Being on the skin, there is a chance that skin conductivity may behave as an electrolyte, allowing Lotion Interfaces to change without the presence of lotion. Depending on desired functionality, designers can facilitate or impede this possibility. Thin substrates, such as the paper tape used in Lotio, enable interactions driven by skin conductance. Alternatively, insulating substrates, such as sticker paper, silicone [205], or temporary tattoos [115], inhibit these types of interactions, albeit limiting the ability for applied lotion to absorb into the skin. Prior work has demonstrated unique interactions resulting from social displays of skin conductance [69]. Lotion Interfaces present an opportunity to co-locate biosignal sensing and display. In addition, Lotion Interfaces could be actuated by sweat, tears, rainwater, and any other substance capable of acting as an electrolyte. This enables a wide range of interactive capabilities, from exercise monitoring to weather reactive makeups and new forms of personal expression.

Body Integration & Application Methodology

Lotio’s form factor is an overlay on the surface of the skin; however, there are many other ways that Lotion Interfaces can be integrated with the body. Lotion-reactive materials could be integrated into make-ups [86], henna, nail art [94], and more permanent body decorations like tattoos [195]. A key design consideration in choosing a form factor is frequency of application. Make-up is applied daily, nail polish weekly or monthly, and tattoos much less frequently. Different interactions, applications, and experiences are possible with different implementations.

Beyond the Skin

As mentioned previously, Lotio is just one of many potential embodiments of Lotion Interfaces. Rather than changing visual appearance, Lotion Interfaces could alter the texture of skin [202, 89] and other properties. Expanding the notion of lotion to include hair gels, mousses, and creams, we can consider novel interactions with dynamic hair [191].

8.8 Summary

This chapter explored Lotion Interfaces as a new interaction modality for skin-based technologies directly inspired by existing body practices. Leveraging the rich cultural traditions of lotion usage, Lotion Interfaces are skin-worn interfaces that sense and respond to applied lotions (moisturizers, sunscreens, makeups, medicinal creams, and ointments, among others).

I highlighted design considerations for Lotion Interfaces related to *physicality*, *usage patterns* (infrequent interactions), *removability* (absorption), *mutability* (transform the skin), *social & cultural considerations* (diversity of skin), *customizability* (personalization), and *aesthetics*.

I discussed the design and fabrication of Lotio, an exemplar Lotion Interface. Lotio is a lotion-reactive, skin-worn electrochromic display. Lotio leverages capacitive sensing to detect lotion application and touch gestures on the surface of the skin. When lotion is present, Lotio behaves as a computationally-controllable display, with segmented portions of the design becoming more or less saturated. When the lotion is absorbed or removed, the visual display can no longer change, rendering Lotio bistable.

I described a preliminary user study conducted to understand perceptions and usage of lotion-mediated interaction. Participants were introduced to the Lotio prototype and invited to wear it on a body location of their choosing. In addition, the study included a semi-structured interview, and an assessment of visibility on mannequin heads with varying skin tones. The user study revealed insights relevant to the design of Lotion Interfaces. In deciding appropriate locations for Lotion Interfaces, participants were concerned with visibility, accessibility, and existing cosmetic practices. Participants envisioned a broad range of contexts of use spanning health, fitness, personal expression, and social applications. Overall, participants appreciated the “seamless” integration of technology with the body &

its practices and desired further body integration. Finally, I highlighted a range of practical and playful applications for Lotion Interfaces including personal health monitoring, dynamic & temporal user interfaces, and dynamic personal expression.

This chapter and the preceding four have demonstrated how the framework can highlight opportunities and challenges for diverse designs spanning a broad range of body locations: artificial fingernails, hair, clothing & accessories, hats, and skin. The parameters of the framework have been leveraged to motivate body locations, compare form factors, inform input modalities, navigate constraints, and highlight opportunities for design. The next chapter reflects on how the presented framework can inspire additional wearable designs, as well as how it can be generalized to other design practices.

Chapter 9

Discussion

This thesis introduced *Heirloom Wearables* as a new class of wearable technologies, and presented a framework to facilitate their design. To operationalize the framework, I presented five *Heirloom Wearable* technologies: fingernail devices, interactive hair, dynamic clothing & accessories, interactive hats, and lotion interfaces. These wearable technologies were explicitly designed to explore and expand key elements of the framework.

The fingernail devices presented in Chapter 4 were designed to explore the impact of removability on the design of *Heirloom Wearables*. Devices that are infrequently removed have unique power requirements that impose additional constraints on display, sensing, and potential interactions. The presented devices demonstrated how these limitations provide a constrained but rich design space appropriate for small, functional, and fashionable *Heirloom Wearables*.

The exploration of hair as a design material (Chapter 5) probed the interactive affordances of the body. Individuals have habits and existing gesture vocabularies with their bodies and body-worn artifacts. The design and implementation of HÄIRÖ demonstrated how leveraging existing form factors with familiar interactions can facilitate embodied interaction and meaningful engagements with on-body technologies.

Embodying various forms of clothing and accessories, AlterWear was designed to explore usage patterns related to maintenance (Chapter 6). Designing for low maintenance imposed strict technical limitations related to power and display capabilities; however, these limitations defined a rich space of potential interactions.

Chapter 7 explored the design space of interactive hats to investigate the role of context in the design of *Heirloom Wearables*. While commercial wearables are designed independent of context and intended to be worn at any time (excluding sleeping, bathing, and other highly specific contexts), few traditional body-worn artifacts are similarly context-independent. The exploration of interactive hats demonstrated how embodying highly contextual form factors can provide an exciting opportunity to marry function and form in the design of *Heirloom Wearables*.

Lotion Interfaces (Chapter 8) were designed to explore how interaction modalities can be inspired by existing body practices, leveraging semantic priming and existing mental mod-

els to facilitate more personal and intimate interactions with technology on the body.

In this chapter, I reflect on how the presented framework can inspire additional wearable designs. I present several illustrative designs to explore additional elements of the framework, and to demonstrate more concretely how to leverage the framework during the design process. In addition, I reflect on how the framework can be generalized to other design practices.

9.1 Illustrative Designs

As mentioned previously, the framework and the exemplar prototypes were developed contemporaneously, mutually benefiting from one another. To demonstrate how the framework may be used to inspire additional *Heirloom Wearable* technologies and to highlight opportunities overlooked by existing approaches, I will now present several additional designs. In particular, I will illustrate how the framework can be leveraged at three distinct stages of the design process:

1. *Motivate Body Location*: The framework and its parameters can be used to compare, contrast, and motivate body locations for new wearable technologies.
2. *Compare Form Factors*: The framework and its parameters can also be used to compare, contrast, and motivate form factors located at a specific body location. In particular, the framework is effective at teasing out differences between similar artifacts (e.g., clip-in hair extensions & natural hair; baseball cap & safety helmet; purse & backpack).
3. *Highlight Opportunities for Design*: Finally, leveraging the framework to define a design space can highlight current gaps and new opportunities for design. As demonstrated through the illustrative projections throughout this dissertation, the parameters of the framework can be used to map out the design space of existing wearable technologies. Projecting a particular class of prior work (e.g., wearable olfactory interfaces) can identify underexplored areas, highlighting new opportunities for design.

The illustrative designs are a Scarf Interface, Interactive Dentures, and Dynamic Perfume. These designs further demonstrate the *Design Framework for Heirloom Wearables*, highlighting key considerations of *expressivity* (Scarf Interface), *mutability* (Interactive Dentures), and *visibility* (Dynamic Perfume).

Envisionment 1: Scarf Interface

Motivate Body Location

As highlighted in Chapters 6 & 7, various artifacts of clothing and accessories provide compelling body locations for embedded technology. Key characteristics that contribute to the



Figure 9.1: Interactive scarf technology. Scarves are compelling locations for wearable technology because they are highly accessible, frequently removed, and socially acceptable.

rich design space for this class of wearable technologies include *maintenance*, *inherent functions*, and *contexts of use*.

Compare Form Factors

Within the context of traditional clothing & accessories, scarves are unique in terms of mutability and expressivity. While all clothing & accessories can be modified and adjusted throughout the day (sleeves are rolled or pushed up; hoodies are zipped and unzipped), scarves can be styled and restyled in a seemingly endless number of ways. Scarves are also highly accessible, frequently removed, socially acceptable, and often associated with specific contexts, including seasonal or outdoor use. These characteristics define a rich design space for interactive scarf technology.

Highlight Opportunities for Design

Prior work has explored embedding technology in scarf form factors, often focusing on *social acceptability* as a key design consideration. In particular, various assistive technologies have leveraged the familiar and socially acceptable form of a scarf. Profita et al. designed and created LightWear: light-emitting wearable technologies that administer light therapy for treatment of Seasonal Affective Disorder [156]. Two of the six designed wearables leveraged scarf form factors. Bonanni et al. designed and created a haptic modular scarf enabling human touch to be recorded and played back for emotional therapy [14]. Williams et al. presented wearable affective technology in the form of a modular scarf [213]. The presented technology, SWARM, embedded various actuators for emotion awareness.

Von Radziewsky et al. demonstrated the highly interactive nature of scarves through the design and implementation of Scarfy: a scarf interface capable of detecting the way it is tied [157]. In addition, Scarfy included vibration motors and shape memory alloy to

enable expressive outputs in the form of vibration and shape change. Inspired by these prior works, as well as the interactive affordances of scarves, consider the following scenario with illustrative scarf technology.

Anoush scrolls through Instagram underneath her desk during her anthropology class. Seeing her friend Fadi has posted a photo from last night’s dinner party, Anoush likes the post and uploads a photo of her own just before leaving class. Anoush dons her winter coat and drapes her Scarf Interface around her neck, tying it in a French knot. Sensing its styling, the scarf begins monitoring Anoush’s Instagram. Anoush walks across campus to meet Fadi for coffee, feeling a flurry of small vibrations on the back of her neck —one for each new like. The tails of her scarf kick outwards three times, indicating new comments. Anoush feels delight as she experiences embodied engagements with her digital data. After finishing her coffee and saying goodbye to Fadi, Anoush again dons her winter coat and Scarf Interface. This time, she drapes the scarf around her neck two times. Sensing this, the scarf begins wireless communication with a paired scarf belonging to Anoush’s sister Nareh. Anoush tugs the right tail of her scarf, which causes Nareh’s scarf to feel warm on the back of her neck. Feeling connected to her sister, Nareh coils the tail her of own scarf around her hand. This gesture is replayed on Anoush’s scarf: the tail that she had just tugged begins to coil in midair. Anoush and her sister send scarf gestures back and forth as she walks through the campus. Returning to her dorm, Anoush hangs her Scarf Interface on a hook by the front door, where it wirelessly charges overnight.

This envisioned scenario demonstrates how interactive scarf technology can increase both the *sociality* and *communicative reach* of traditional body-worn artifacts. Furthermore, interactive scarf technology can leverage the unique *mutability* of scarves to enable expressive interactions with technology on the body.

Envisionment 2: Interactive Dentures

Motivate Body Location

Figure 9.2 is a two dimensional projection of the *visibility* and *rigidity* of several body parts and body-worn artifacts. This mapping highlights the unique affordances of teeth as a rigid part of the body that is only visible to others (rather than the wearer themselves).

Compare Form Factors

Figure 9.3 is a two dimensional projection of the *removability* and *aestheticism* of various teeth-worn artifacts. From braces to dentures and veneers, teeth-worn artifacts are diverse and span from purely functional (retainers [111]) to purely aesthetic (dental piercings), as well as from not removable except by dental professionals (implants [8]) to frequently removed

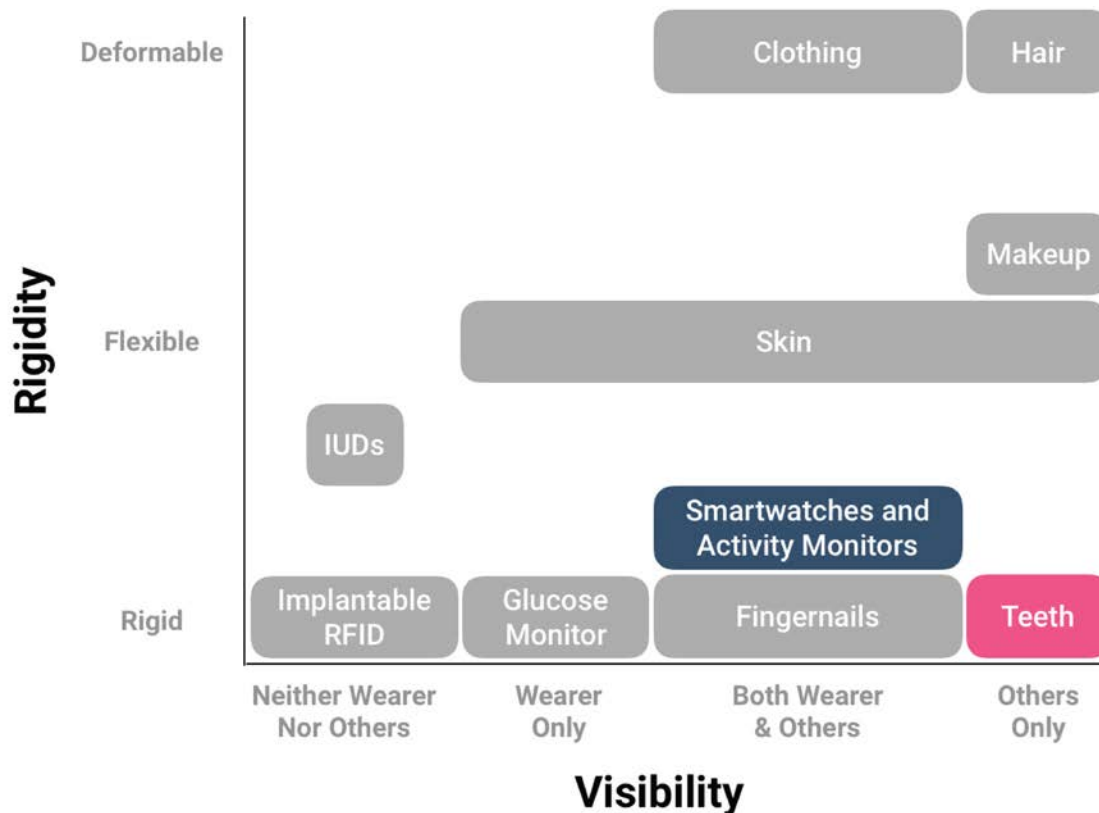

Figure 9.2: Visibility and Rigidity of various body-worn artifacts. Teeth (shown in pink) occupy a unique position in the design space as part of the body that is rigid, but only visible to others. Commercially prevalent wearable devices are shown in dark blue.

(grills [24]). This design space highlights the versatility of dentures, which can be worn for either functional or aesthetic means (or some combination of the two), and range from fixed (not removable except by a dental professional) to easily and frequently removed.

Highlight Opportunities for Design

Figure 9.4 is a two dimensional projection of the *mutability* and *interactivity* of various body-worn artifacts. Unaugmented teeth (shown in pink) are static and not often changed. Prior work explored teeth-worn devices leveraging bone conduction to improve hearing [57], provide new methods of communication [8, 170], and enable a playful music player [24]. In terms of input, several wearable systems have leveraged the surface of the teeth [154, 134, 7, 189]. In addition, TongueBoard embedded capacitive touch sensors in a retainer form factor to characterize non-vocalized speech [111]. While these prior works have increased the *interactivity* of various teeth-worn artifacts, they all maintain infrequent *mutability*. This

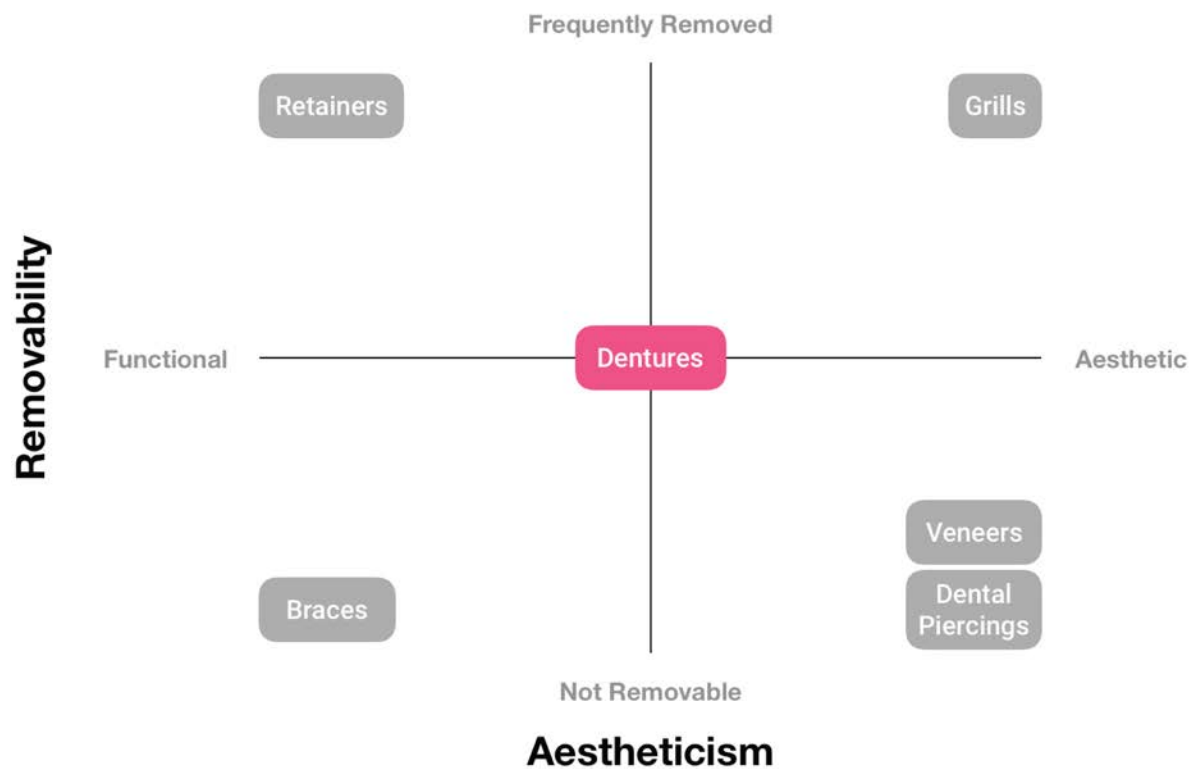

Figure 9.3: Removability and Aestheticism of various teeth-worn artifacts. In this design space, dentures (shown in pink) are versatile as a form factor that can be functional or aesthetic, not removable or frequently removed.

design space highlights an opportunity for wearable technology in the form of interactive dentures to transform the teeth into a more interactive, frequently modified artifact.

Furthermore, teeth enable innovative sensing and expressive output because there is a sensing modality specific to this body location: taste. Interactive dentures capable of sensing characteristics related to taste can intuitively interpret user experience; interactive dentures can also leverage taste as a form of expressive output unique from existing technologies. Consider the following scenario with interactive dentures.

After turning off his morning alarm, Rohan reaches for his Interactive Dentures and slides them into position. As he is making coffee, he clicks his teeth twice [7, 189] to turn on his favorite podcast, and taps his tongue against his top right canine tooth to increase the volume [134]. Sensing coffee at the molars, Rohan's Interactive Dentures begin monitoring coffee intake, which is then communicated to Rohan's health monitoring mobile app. Thirty minutes later, it is time for

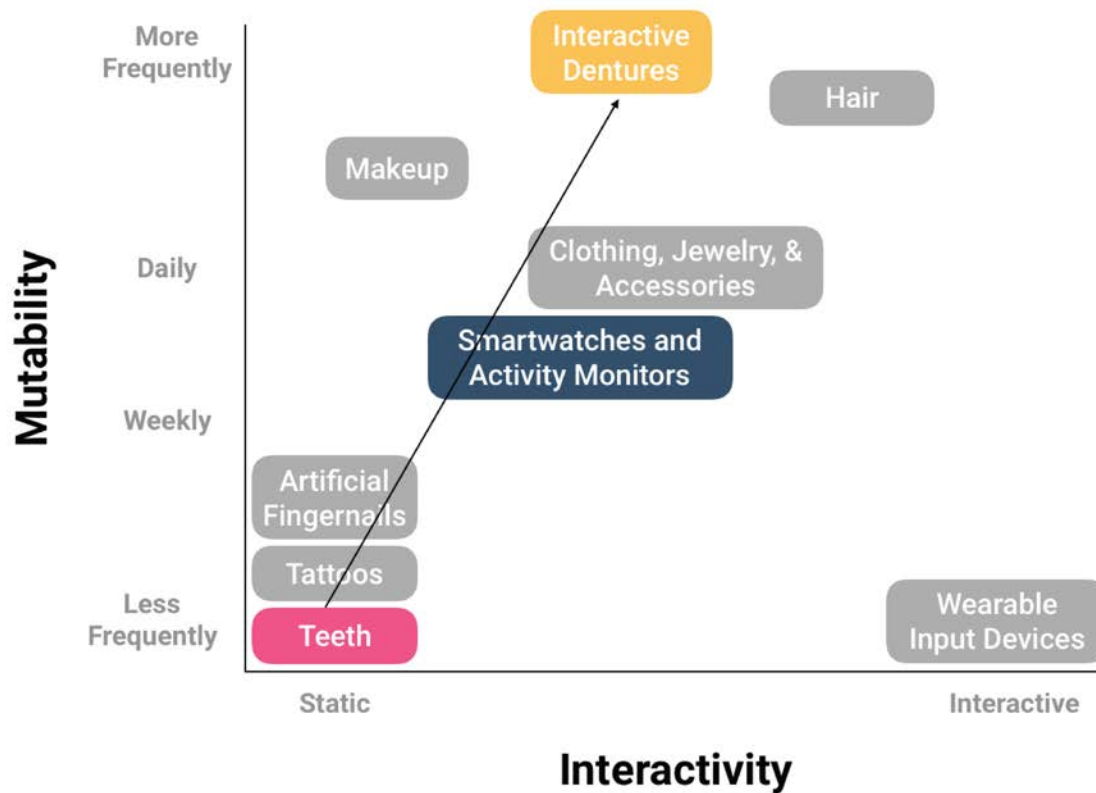

Figure 9.4: Mutability and Interactivity of various body-worn artifacts. Embedded technology in the form of interactive dentures has the possibility to transform teeth (shown in pink) from static and infrequently modified to interactive and malleable (shown in yellow). Commercially prevalent wearable technologies are shown in dark blue.

Rohan to take his cholesterol medication. His Interactive Dentures change texture, feeling gritty against the surface of Rohan’s tongue. Adequately reminded, Rohan takes his medication and slides his tongue across the back of his incisors to dismiss the notification. His Interactive Dentures return to their original smooth texture.

This envisioned scenario demonstrates how interactive dentures may increase both the *mutability* and *interactivity* of traditional body-worn artifacts (See Figure 9.4).

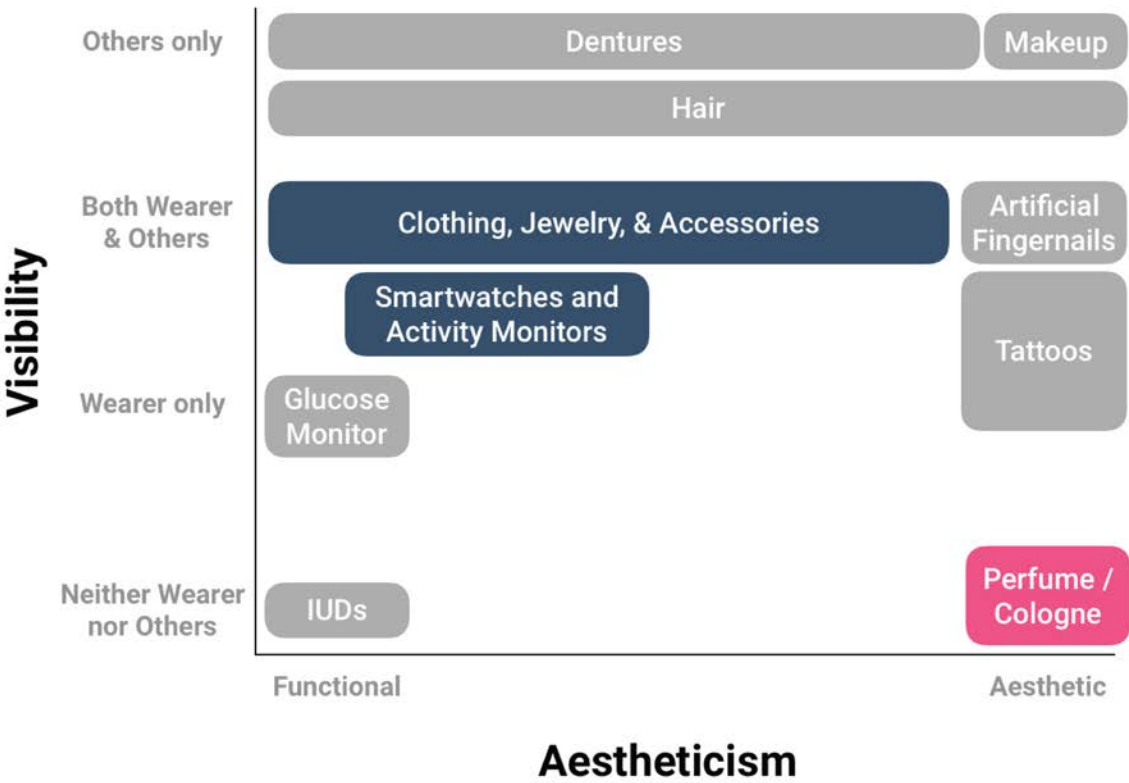

Figure 9.5: Visibility and Aestheticism of various body-worn artifacts. Perfumes & Colognes (shown in pink) occupy a unique location in the design space as a body-worn artifact that is purely aesthetic but neither visible to the wearer nor others. Commercially prevalent wearable technologies are shown in dark blue.

Envisionment 3: Dynamic Perfume

Motivate Body Location

Figure 9.5 is a two dimensional projection of the Aestheticism and Visibility of several body parts and body-worn artifacts. This mapping highlights the unique affordances of perfumes and colognes as a highly aesthetic artifact that is neither visible to the wearer nor others.

Compare Form Factors

Figure 9.6 is a two dimensional projection of the Body Location and Noticeability of various body-worn artifacts. In this projection, *noticeability* specifically refers to the scent of the body location or wearable artifact. For the sake of comparison, I am specifically referring to subtle and limited scent dispersion; obviously, strong and powerful scents would be noticeable

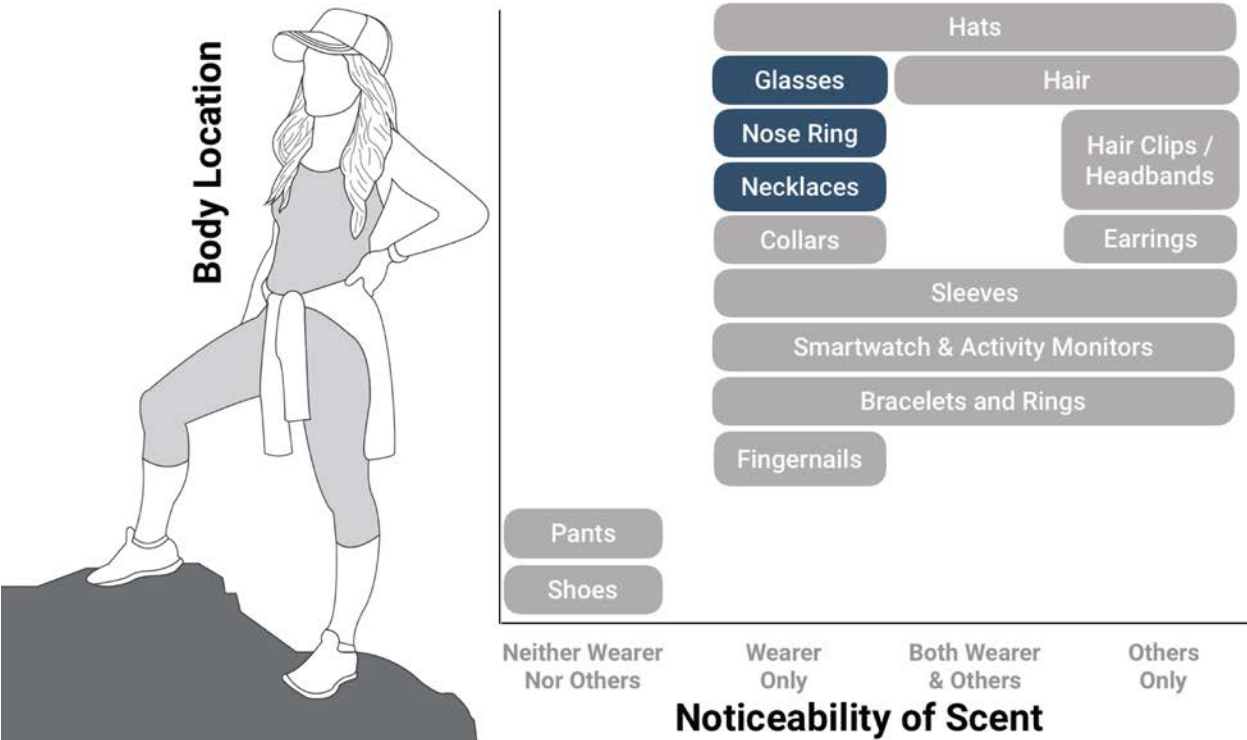

Figure 9.6: Body Location and Noticeability of various body-worn artifacts. In this projection, noticeability specifically refers to the scent of the body location or wearable artifact. Form factors that have previously been leveraged for olfactory interfaces are highlighted in dark blue.

by both parties regardless of the origin body location.

Hats are unique in that different parts of the hat have different noticeability: scent dispensed under the brim is likely only to be noticed by the wearer; scent dispensed from the crown of the hat is likely only to be noticed by others. Depending on hair length, scented hair may be noticed by both the wearer & others, or others only. Artifacts worn on or near the face (such as glasses [30], piercings [200], and necklaces [2, 44]) can disperse scent noticeable only to the wearer. Wrist, hand, and arm-worn artifacts (such as sleeves, smartwatches, bracelets, and rings) are unique in that noticeability of scent depends on the pose of the wearer. Depending on body pose, scent dispersed at this location may be noticeable to the wearer only, others only, or both the wearer & others. Finally, scent dispersed from the lower half of the body (including pants and shoes) is likely not noticeable to any party.

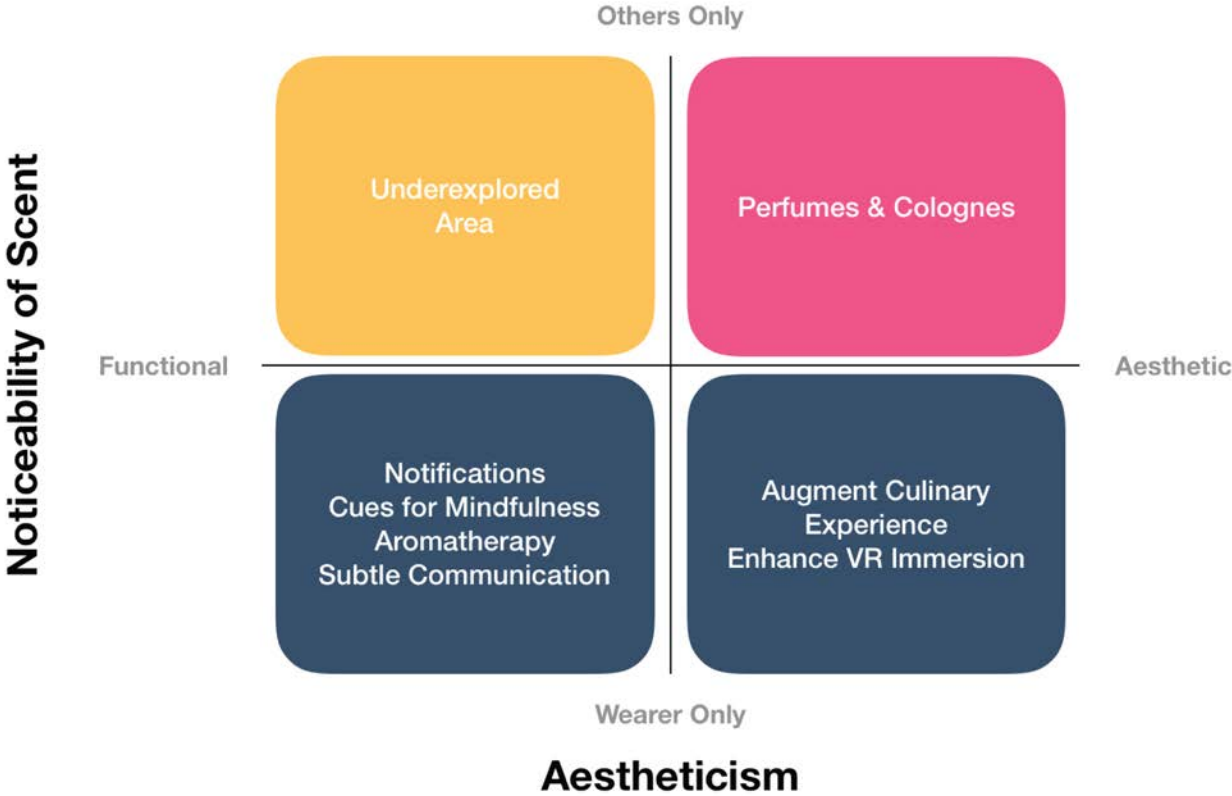

Figure 9.7: Noticeability (scent) and Aestheticism of various applications for wearable olfactory interfaces. The role of traditional perfumes and colognes is shown in pink. Applications proposed by prior work are highlighted in dark blue.

Highlight Opportunities for Design

Figure 9.7 is a two dimensional projection of various applications for wearable olfactory interfaces. Applications proposed by prior work are highlighted in dark blue. The role of traditional perfumes & colognes usage is also shown in the design space (top right: purely aesthetic and noticeable by others). While traditional perfumes & colognes are intended to be noticed by others, existing work [44, 2, 200, 30] has exclusively focused on implementations that limit noticeability to the wearer only, focusing on discreet, personal, and private interactions with scent. These personal interactions have ranged from functional (notifications [44] and aromatherapy [2]) to aesthetic (augmenting culinary experiences [200] and enhancing VR immersion [2]). This mapping highlights the underexplored area of functional olfactory interfaces that expand the noticeability of scent to others (shown in yellow).

As an example, olfactory interfaces may be used as a subtle signal of personal space. Prior work has shown that wearable technologies can expand non-verbal social signals [34],

including indicating personal space. Prior work has demarcated personal space using physical structures [181], as well as sounds [203]. Dynamic Perfume could expand this prior work to include a new modality: scent. Unlike the modalities explored previously (physical structures and sounds), Dynamic Perfume is subtle and only noticeable to the intended target. Variations in scent could delineate personal space, both scaring off intruders with unpleasant scents and welcoming friends & loved ones with agreeable ones. Consider the following scenario with dynamic perfume.

Climbing onto the bus just as the doors are closing, Neil wedges between the window and a woman wearing a leather jacket with studs on the shoulders. Inexplicably, he begins to smell the distinct scent of skunk. Looking around him, no one else seems to have noticed. Judging the woman's jacket as the origin of the smell, Neil moves to an open seat on the other side of the bus. Cristina is meeting her friend Asha downtown to celebrate finally living in the same city after 3 years on separate coasts. She spots Asha stepping off the bus in a studded leather jacket, and rushes over to give her a big hug. As she does, she smells the distinct scent of toasted vanilla, and is reminded of baking with Asha back when they were roommates in college.

This is just one example of many potential functional olfactory interfaces that are noticeable to others.

9.2 Extensions of the Framework

The exemplar prototypes and illustrative designs presented in this dissertation have demonstrated how the framework can be used to design *Heirloom Wearable* technologies. However, the flexibility of the framework allows it to be used in a multitude of different ways. I will now discuss a few of these extensions of the framework.

Inclusive Design

In contrast with Universal Design, the presented framework can be used for Inclusive Design [31], explicitly focusing on persons, groups, and demographics that have historically been excluded from existing wearable solutions. Answering the guiding questions with a particular group in mind can inspire inclusive wearable devices. In line with the goals of Beauty Technology [193], the framework can identify challenges and opportunities when designing specifically for women. While not exclusive to this demographic, the presented exemplar prototypes in the form of false fingernails and interactive hair demonstrate how designing a diverse range of wearable technologies can broaden engagement. Focusing specifically on mothers, the framework can highlight relevant concerns, perhaps inspiring a teething necklace that senses oral health of the child.

Beyond Wearables

This dissertation introduced a framework for designing new wearable technologies; however, designers of non-wearable technologies may benefit from the presented approach and the notion of *Heirloom Technology*.

Internet of Things Design

Similar to how the framework can be used to (1) Motivate Body Location, (2) Compare Form Factors, and (3) Highlight Opportunities for Design of new and innovative wearable technologies, the framework can also be leveraged in the design of Internet of Things devices. However, some considerations scale more readily to the design of everyday things. For instance, *removability* doesn't have a immediate counterpart in the context of "things" that are not worn on the body, but can be adapted to address removal from the home or associated environment. Alternatively, considerations such as *physicality*, *usage patterns*, and *customizability* directly translate.

Design of Input Devices

Wearable or not, the design of input devices may benefit from the guiding questions presented in the framework, particularly with regards to *usage patterns* and *social & cultural considerations*. Considering existing practices, gestures, and interactivity of objects and surfaces may provide new insights into potential inputs, as well as provide a baseline with which to evaluate new technologies. Examining *social & cultural considerations* throughout the design process may facilitate the design and creation of input technologies that are more socially acceptable, universal, and potentially encourage or prevent social interactions.

9.3 Synthesis

The presented Scarf Interface, Interactive Dentures, and Dynamic Perfume are just a few of many *Heirloom Wearables* that can be informed and designed through the presented framework. As evidenced through the underexplored areas highlighted in the projected design spaces, these designs do not emerge so readily without the presented *Design Framework for Heirloom Wearables*. The exemplar prototypes (Chapters 4 - 8) and the Illustrative Designs demonstrate how the framework can highlight new opportunities for wearable technologies and beyond.

The field of Human-Computer Interaction (HCI) considers human factors relating to the design, implementation, and evaluation of interactive computing systems. While the work presented in this dissertation is clearly HCI, the presented methodology extends beyond the current reaches of the field, advocating for a distinct focus on the body and its practices through several lenses: behavioral, societal, cultural, and beyond. Leveraging the *Design Framework for Heirloom Wearables* in the design of both wearable and non-wearable objects

diverges from traditional HCI approaches in the exploration of the body and its practices independent of technology.

Chapter 10

Conclusion

This final chapter reviews the contributions of this thesis, identifies limitations, and concludes with a future vision for *Heirloom Wearables*.

10.1 Restatement of Contributions

In this dissertation, I motivated and argued for a new design methodology for wearable technology. I defined *Heirloom Wearables* as body-worn technologies that adopt existing form factors with well-established practices and traditions and addressed two research questions.

RQ1. How can the limitations and constraints of body-based technologies be transformed into opportunities for design?

RQ2. How can body-centric practices inform the design of wearable technologies?

I argued that this class of wearables can leverage limitations and constraints of body-based technologies as opportunities for design (RQ1), and use body-centric practices as inspiration for interaction modalities (RQ2).

C1. Design Framework for Heirloom Wearable Technologies. The framework is presented as a collection of open questions, organized at multiple levels. I extract parameters from these questions, and use them to map out an illustrative design space of wearable technologies.

I presented a *Design Framework for Heirloom Wearables* (C1), highlighting considerations relevant to body location & form factor, as well as the designed wearable device (Chapter 2). The framework is intended to guide designers throughout the design process, beginning with ideation and culminating in evaluation. I demonstrated the framework's ability to characterize existing technologies, as well as to serve as a roadmap for future embodied wearable technologies.

C2. Exemplar Heirloom Wearables. In order to operationalize the presented framework, I present several exemplar wearable technologies developed through this lens: fingernail-worn devices, interactive hair, dynamic clothing and accessories, interactive hats, and lotion interfaces.

I operationalized the framework through the design of several exemplar wearable technologies spanning diverse body locations (C2): fingernail-worn devices (Chapter 4), interactive hair (Chapter 5), dynamic clothing & accessories (Chapter 6), interactive hats (Chapter 7), and lotion interfaces (Chapter 8). These implementations demonstrated how the parameters of the framework can be used to motivate body location, compare form factors, inform input modalities, navigate constraints, and highlight opportunities for design.

Finally, I presented several additional designs envisioned through the framework, and reflected on how the presented considerations may be generalized to other design practices (Chapter 9).

Limitations and Future Studies

A major limitation of this work is the limited evaluation and user testing of designed technologies. All user studies and evaluations presented in this dissertation were conducted in a controlled lab environment for limited duration (approximately 1 hour). While this is sufficient for characterizing initial thoughts and perceptions, it is unclear what experiences and relationships may arise between the user and the technology outside of the controlled environment. It is also unclear what interactions, experiences, and relationships may result from long-term usage. Further research should be conducted to investigate the role of *Heirloom Wearables* in varying contexts and across time. This includes longitudinal studies of *Heirloom Wearables* in everyday contexts. Participants should be given devices to engage with and to incorporate into their daily routines over a period of at least a couple of weeks. This length of study will help to diminish the novelty effect associated with new technologies and allow time for habitual usage patterns to emerge. Longer studies will result in more robust results and deeper insights into perceptions of *Heirloom Wearables*, as well as actual usage patterns. Future work should also explore more unconventional means of distributing *Heirloom Wearables*, such as “droplifting” [146].

Another major limitation of this work is the role of culture in the design, implementation, and evaluation of the presented prototypes. The exemplar prototypes were heavily influenced by the Western culture in which they were developed. In addition, all user study participants were adults in the same Western society. User study results are likely not generalizable across cultures. Future work should further explore the role of culture in the design and evaluation of *Heirloom Wearables*. My hope is for the presented *Design Framework for Heirloom Wearables* to empower individuals from diverse cultural backgrounds to design and develop *Heirloom Wearables* both inspired from and appropriate for their own individual cultures.

10.2 Future Research Directions

This dissertation presented a new class of wearable technologies: *Heirloom Wearables*. In this section, I reflect on existing relationships with on-body technology, and present a future vision for how *Heirloom Wearables* may restructure them.

Humans have a very different relationship with wearable technology than with traditional body-worn artifacts, such as clothing and accessories. In particular, the lifecycle of wearable technologies is very different from the lifecycle of traditional body-worn artifacts. Mirroring other forms of technology (notably smartphones, tablets, and other mobile technology), new versions of wearable devices are constantly being designed and released, rendering previous generations irrelevant. Once these older generations are no longer supported, they become obsolete and are often discarded. In contrast, the lifecycle of traditional body-worn artifacts is much more nuanced. While clothing & accessories certainly go in and out of style, they are rarely rendered obsolete. Rather than being discarded, articles are more often handed down to siblings, sold in yard sales, listed online, or donated. The notable exception is fast fashion, where cheap articles of clothing are replaced and disposed of at a rapid rate. This distinction between lifecycles of wearable technology and traditional body-worn artifacts is well demonstrated through the popularity of thrift shops and vintage clothing stores. Although commonplace for clothing and accessories, it is difficult to envision a similar resale culture for outdated wearable technologies.

In contrast with existing practices and attitudes towards wearable technologies, I envision a future where relationships with *Heirloom Wearables* more closely resemble relationships with traditional body-worn artifacts. This requires a shift in the design, as well as the interpretation of wearable technology. Rather than focusing on functionality and efficiency (which will always be superseded and rendered obsolete), designers of wearable devices must focus on cultivating experiences and meaningful relationships that imbue the artifact with inherent value.

This shift towards designing *Heirloom Wearables* has the potential to decrease the environmental impact of wearable technology, particularly with regards to e-waste [65]. Paralleling existing practices with traditional body-worn artifacts, *Heirloom Wearables* can foster attitudes of repair rather than disposal. Inspired by traditional nail salons, wearers may go to tech nail salons to have their fingernail-worn devices repaired, reprogrammed, removed, recycled, and replaced. Tech hair salons may offer similar services for interactive hair. Tech tailors may specialize in e-textiles: adjusting fit & functionality, repairing unraveling conductive traces, and refashioning dated garments. This attitude towards *Heirloom Wearables* can promote longer usage of wearable technologies, extending beyond a single owner. However, the longevity of *Heirloom Technology* faces challenges of *discoverability* and *compatibility*.

- **Discoverability:** For a technology to be useful beyond a single user, its affordances and capabilities must be *discoverable*. A second or third owner must be able to discover the capabilities of the device without quick start guides, setup dialogues, or factory settings. One solution is for future *Heirloom Wearables* to embed usage prompts

within the artifact itself: leveraging clothing labels, jewelry inscriptions, or cosmetic directions.

- **Compatibility:** While designing for experiences and relationships over functionality and efficiency promises increased device longevity, device compatibility still threatens prolonged usage. Unless the wearable device is entirely self-contained and doesn't rely on any external devices or technologies (e.g., smartphones, smartwatches, other tethered devices, Bluetooth, NFC, WiFi, Cellular Data, etc), the device is liable to obsolescence when the underlying technology is no longer supported. This is not to say that obsolete *Heirloom Wearables* will be discarded. They may be treasured and collected similar to other outdated technologies (i.e., vinyl records, video game consoles, vintage cameras, etc).

I imagine an *Heirloom Wearable* borrowed by a roommate, handed down to a younger sibling, and later shared among close friends. I imagine an *Heirloom Wearable* abandoned at a thrift shop, finding new life through repurchase. I imagine handcrafted *Heirloom Wearables* gifted to close friends and family around the holidays. I imagine an *Heirloom Wearable* collecting dust in an attic until it is rediscovered and refashioned by a new wearer. I imagine *Heirloom Wearables* passed down through generations —heirlooms in the literal sense.

10.3 Summary

In this dissertation, I addressed two research questions.

RQ1. How can the limitations and constraints of body-based technologies be transformed into opportunities for design?

Through the design and implementation of exemplar *Heirloom Wearables*, I demonstrated the ability of the framework to highlight limitations specific to a body location or form factor, and leverage them as opportunities for design. These limitations include small physical size & limited removability (Chapter 4), inherent functions & contexts of use (Chapter 7), as well as interaction limitations related to maintenance (Chapter 6). I presented *Heirloom Wearables* that demonstrate constrained but rich design spaces around body locations and form factors with strict limitations.

RQ2. How can body-centric practices inform the design of wearable technologies?

I presented a *Design Framework for Heirloom Wearables* that includes guiding questions designed to surface existing body-centric practices. Through the exemplar prototypes, I demonstrated how these existing practices may impose strict limitations on potential interactions (RQ1), but also how they can directly inspire wearable technologies: informing interaction modalities (Chapter 8), and inspiring expressive outputs (Chapter 5). Furthermore,

I argued that wearable technologies can take inspiration from experiences and relationships with traditional body-worn artifacts.

The Design Framework and exemplar *Heirloom Wearables* presented in this dissertation contribute to a design methodology for inspiring a more diverse range of wearable technologies. This new landscape of devices will blur the distinction between modern wearable technologies and traditional body-worn artifacts, fostering meaningful and intimate relationships with technology on the body.

Bibliography

- [1] Petra Ahde and Jussi Mikkonen. “Hello: Bracelets Communicating Nearby Presence of Friends”. In: *Proceedings of the Tenth Anniversary Conference on Participatory Design 2008*. PDC '08. Bloomington, Indiana: Indiana University, 2008, pp. 324–325. ISBN: 9780981856100.
- [2] Judith Amores and Pattie Maes. “Essence: Olfactory interfaces for unconscious influence of mood and cognitive performance”. In: *Proceedings of the 2017 CHI conference on human factors in computing systems*. 2017, pp. 28–34.
- [3] Peter Andersson et al. “Printable all-organic electrochromic active-matrix displays”. In: *Advanced Functional Materials* 17.16 (2007), pp. 3074–3082.
- [4] Shaikh Shawon Arefin Shimon et al. “Exploring Non-touchscreen Gestures for Smartwatches”. In: *Proceedings of the 2016 CHI Conference on Human Factors in Computing Systems*. CHI '16. San Jose, California, USA: ACM, 2016, pp. 3822–3833. ISBN: 978-1-4503-3362-7. DOI: 10.1145/2858036.2858385. URL: <http://doi.acm.org/10.1145/2858036.2858385>.
- [5] Jatin Arora et al. “Gehna: Exploring the Design Space of Jewelry as an Input Modality”. In: *Proceedings of the 2019 CHI Conference on Human Factors in Computing Systems*. CHI '19. Glasgow, Scotland Uk: Association for Computing Machinery, 2019, pp. 1–12. ISBN: 9781450359702. DOI: 10.1145/3290605.3300751. URL: <https://doi.org/10.1145/3290605.3300751>.
- [6] Daniel Ashbrook, Patrick Baudisch, and Sean White. “Nenya: Subtle and Eyes-free Mobile Input with a Magnetically-tracked Finger Ring”. In: *Proceedings of the SIGCHI Conference on Human Factors in Computing Systems*. CHI '11. Vancouver, BC, Canada: ACM, 2011, pp. 2043–2046. ISBN: 978-1-4503-0228-9. DOI: 10.1145/1978942.1979238. URL: <http://doi.acm.org/10.1145/1978942.1979238>.
- [7] Daniel Ashbrook et al. “Bitey: An Exploration of Tooth Click Gestures for Hands-Free User Interface Control”. In: *Proceedings of the 18th International Conference on Human-Computer Interaction with Mobile Devices and Services*. MobileHCI '16. Florence, Italy: Association for Computing Machinery, 2016, pp. 158–169. ISBN: 9781450344081. DOI: 10.1145/2935334.2935389. URL: <https://doi.org/10.1145/2935334.2935389>.

- [8] J Auger and J Loizeau. *Audio tooth implant*. 2001.
- [9] Leslie Baumann. “Understanding and treating various skin types: the Baumann Skin Type Indicator”. In: *Dermatologic clinics* 26.3 (2008), pp. 359–373.
- [10] Jane Bennett. *Vibrant Matter: A Political Ecology of Things*. Duke University Press, 2010.
- [11] Mary Ellen Berglund, Julia Duvall, and Lucy E Dunne. “A Survey of the Historical Scope and Current Trends of Wearable Technology Applications”. In: *Proceedings of the 2016 ACM International Symposium on Wearable Computers*. ISWC ’16. Heidelberg, Germany: Association for Computing Machinery, 2016, pp. 40–43. ISBN: 9781450344609. DOI: 10.1145/2971763.2971796. URL: <https://doi.org/10.1145/2971763.2971796>.
- [12] Joanna Berzowska. “Memory rich clothing: second skins that communicate physical memory”. In: *Proceedings of the 5th conference on Creativity & cognition*. 2005, pp. 32–40.
- [13] Joanna Berzowska and Marcelo Coelho. “Kukkia and Vilkas: Kinetic Electronic Garments”. In: *Proceedings of the 2005 Ninth IEEE International Symposium on Wearable Computers*. ISWC ’05. Osaka, Japan: IEEE Computer Society, 2005, pp. 82–85. ISBN: 0-7695-2419-2. DOI: 10.1109/ISWC.2005.29. URL: <http://dl.acm.org/citation.cfm?id=1105288>.
- [14] Leonardo Bonanni et al. “TapTap: a haptic wearable for asynchronous distributed touch therapy”. In: *CHI’06 extended abstracts on Human factors in computing systems*. 2006, pp. 580–585.
- [15] Ruby Buddemeyer. *PSA: Your Acrylic Nails Should Last Between 6 to 8 Weeks*. Oct. 2019. URL: <https://www.cosmopolitan.com/style-beauty/beauty/a29105767/acrylic-nails-last-longer/>.
- [16] Leah Buechley and Michael Eisenberg. “The LilyPad Arduino: Toward wearable engineering for everyone”. In: *IEEE Pervasive Computing* 7.2 (2008), pp. 12–15.
- [17] Leah Buechley et al. “The LilyPad Arduino: using computational textiles to investigate engagement, aesthetics, and diversity in computer science education”. In: *Proceedings of the SIGCHI conference on Human factors in computing systems*. 2008, pp. 423–432.
- [18] V Bush. *As we may think*. *Life Magazine*. 1945. 1945.
- [19] Vannevar Bush et al. “As we may think”. In: *The atlantic monthly* 176.1 (1945), pp. 101–108.
- [20] Xuan Cao et al. “Fully screen-printed, large-area, and flexible active-matrix electrochromic displays using carbon nanotube thin-film transistors”. In: *ACS nano* 10.11 (2016), pp. 9816–9822.

- [21] Stuart K Card, Jock D Mackinlay, and George G Robertson. “A morphological analysis of the design space of input devices”. In: *ACM Transactions on Information Systems (TOIS)* 9.2 (1991), pp. 99–122.
- [22] Jessica R. Cauchard et al. “Drone & Me: An Exploration into Natural Human-drone Interaction”. In: *Proceedings of the 2015 ACM International Joint Conference on Pervasive and Ubiquitous Computing*. UbiComp '15. Osaka, Japan: ACM, 2015, pp. 361–365. ISBN: 978-1-4503-3574-4. DOI: 10.1145/2750858.2805823. URL: <http://doi.acm.org/10.1145/2750858.2805823>.
- [23] Matthew J Chabalko, Mohsen Shahmohammadi, and Alanson P Sample. “Quasistatic Cavity Resonance for Ubiquitous Wireless Power Transfer”. In: *PloS one* 12.2 (2017), e0169045.
- [24] Aisen Caro Chacin. “Play-A-Grill: Music To Your Teeth.” In: *NIME*. 2012.
- [25] Edwin Chan et al. “User Elicitation on Single-hand Microgestures”. In: *Proceedings of the 2016 CHI Conference on Human Factors in Computing Systems*. CHI '16. San Jose, California, USA: ACM, 2016, pp. 3403–3414. ISBN: 978-1-4503-3362-7. DOI: 10.1145/2858036.2858589. URL: <http://doi.acm.org/10.1145/2858036.2858589>.
- [26] Liwei Chan et al. “FingerPad: private and subtle interaction using fingertips”. In: *Proceedings of the 26th annual ACM symposium on User interface software and technology*. UIST '13. St. Andrews, UK: ACM, 2013, pp. 1461–1464. ISBN: 978-1-4503-2268-3. DOI: 10.1145/2501988.2502016. URL: <http://doi.acm.org/10.1145/2501988.2502016>.
- [27] Ke-Yu Chen, Shwetak N Patel, and Sean Keller. “Finexus: Tracking precise motions of multiple fingertips using magnetic sensing”. In: *Proceedings of the 2016 CHI Conference on Human Factors in Computing Systems*. ACM. 2016, pp. 1504–1514.
- [28] Huanyu Cheng et al. “Analysis of a concentric coplanar capacitor for epidermal hydration sensing”. In: *Sensors and Actuators A: Physical* 203 (2013), pp. 149–153.
- [29] Beverly Chico. *Hats and Headwear around the World: A Cultural Encyclopedia*. ABC-CLIO, 2013.
- [30] Yongsoon Choi et al. “Sound perfume: building positive impression during face-to-face communication”. In: *SIGGRAPH Asia 2012 Emerging Technologies*. 2012, pp. 1–3.
- [31] P John Clarkson et al. *Inclusive design: Design for the whole population*. Springer Science & Business Media, 2013.
- [32] E-ink Corporation. *E Ink Segmented Displays: Evaluation Guide Version 2.0*. Ed. by eink.com. Sept. 2012. URL: http://www.eink.com/sell_sheets/segmented_evaluation_guide.pdf.
- [33] E-ink Corporation. *E Ink Segmented Displays: Prototype Display Design Rules Version 2.0*. Ed. by eink.com. 2012. URL: http://www.eink.com/sell_sheets/segmented_design_rules.pdf.

- [34] Ella Dagan et al. “Design Framework for Social Wearables”. In: *Proceedings of the 2019 on Designing Interactive Systems Conference*. DIS ’19. San Diego, CA, USA: Association for Computing Machinery, 2019, pp. 1001–1015. ISBN: 9781450358507. DOI: 10.1145/3322276.3322291. URL: <https://doi.org/10.1145/3322276.3322291>.
- [35] Artem Dementyev, Tomás Vega Gálvez, and Alex Olwal. “SensorSnaps: Integrating Wireless Sensor Nodes into Fabric Snap Fasteners for Textile Interfaces”. In: *Proceedings of the 32nd Annual ACM Symposium on User Interface Software and Technology*. 2019, pp. 17–28.
- [36] Artem Dementyev et al. “Wirelessly powered bistable display tags”. In: *Proceedings of the 2013 ACM international joint conference on Pervasive and ubiquitous computing*. UbiComp ’13. Zurich, Switzerland: ACM, 2013, pp. 383–386. ISBN: 978-1-4503-1770-2. DOI: 10.1145/2493432.2493516. URL: <http://dl.acm.org/citation.cfm?id=2493516>.
- [37] Maison G. DeNavarre. “Oils and fats, the historical cosmetics”. In: *Journal of the American Oil Chemists’ Society* 55.4 (Apr. 1978), pp. 435–437. ISSN: 1558-9331. DOI: 10.1007/BF02911908. URL: <https://doi.org/10.1007/BF02911908>.
- [38] Laura Devendorf et al. ““I don’t Want to Wear a screen”: Probing Perceptions of and Possibilities for Dynamic Displays on Clothing”. In: *Proceedings of the 2016 CHI Conference on Human Factors in Computing Systems*. CHI ’16. Santa Clara, California, USA: ACM, 2016, pp. 6028–6039. ISBN: 978-1-4503-3362-7. DOI: 10.1145/2858036.2858192. URL: <http://doi.acm.org/10.1145/2858036.2858192>.
- [39] Christine Dierk, Molly Jane Pearce Nicholas, and Eric Paulos. “AlterWear: Battery-Free Wearable Displays for Opportunistic Interactions”. In: *Proceedings of the 2018 CHI Conference on Human Factors in Computing Systems*. CHI ’18. Montreal QC, Canada: Association for Computing Machinery, 2018, pp. 1–11. ISBN: 9781450356206. DOI: 10.1145/3173574.3173794. URL: <https://doi.org/10.1145/3173574.3173794>.
- [40] Christine Dierk, Tomás Vega Gálvez, and Eric Paulos. “AlterNail: Ambient, Battery-less, Stateful, Dynamic Displays at Your Fingertips”. In: *Proceedings of the 2017 CHI Conference on Human Factors in Computing Systems*. CHI ’17. Denver, Colorado, USA: Association for Computing Machinery, 2017, pp. 6754–6759. ISBN: 9781450346559. DOI: 10.1145/3025453.3025924. URL: <https://doi.org/10.1145/3025453.3025924>.
- [41] Christine Dierk et al. “HäirIÖ: Human Hair as Interactive Material”. In: *Proceedings of the Twelfth International Conference on Tangible, Embedded, and Embodied Interaction*. TEI ’18. Stockholm, Sweden: Association for Computing Machinery, 2018, pp. 148–157. ISBN: 9781450355681. DOI: 10.1145/3173225.3173232. URL: <https://doi.org/10.1145/3173225.3173232>.

- [42] Christine Dierk et al. “Use Your Head! Exploring Interaction Modalities for Hat Technologies”. In: *Proceedings of the 2019 on Designing Interactive Systems Conference*. DIS '19. San Diego, CA, USA: Association for Computing Machinery, 2019, pp. 1033–1045. ISBN: 9781450358507. DOI: 10.1145/3322276.3322356. URL: <https://doi.org/10.1145/3322276.3322356>.
- [43] IDATE DigiWorld. *Number of NFC-enabled mobile devices worldwide from 2012 to 2018 (in million units)*. Ed. by statista.com. 2018. URL: <https://www.statista.com/statistics/461494/nfc-enabled-mobile-devices-worldwide/>.
- [44] David Dobbelsstein, Steffen Herrdum, and Enrico Rukzio. “InScent: A Wearable Olfactory Display as an Amplification for Mobile Notifications”. In: *Proceedings of the 2017 ACM International Symposium on Wearable Computers*. ISWC '17. Maui, Hawaii: Association for Computing Machinery, 2017, pp. 130–137. ISBN: 9781450351881. DOI: 10.1145/3123021.3123035. URL: <https://doi.org/10.1145/3123021.3123035>.
- [45] Lucy E Dunne et al. “The social comfort of wearable technology and gestural interaction”. In: *2014 36th annual international conference of the IEEE engineering in medicine and biology society*. IEEE. 2014, pp. 4159–4162.
- [46] Fajar Akhmad Dwiputra et al. “Accelerometer-Based Recorder of Fingers Dynamic Movements for Post-Stroke Rehabilitation”. In: *International Journal on Advanced Science, Engineering and Information Technology* 7.1 (2017), pp. 299–304. ISSN: 2088-5334. DOI: 10.18517/ijaseit.7.1.1973. URL: http://ijaseit.insightsociety.org/index.php?option=com_content&view=article&id=9&Itemid=1&article_id=1973.
- [47] Chris Edwards. “Wearable computing struggles for social acceptance”. In: *IEEE Review* 49.9 (Jan. 2003), pp. 24–25. DOI: 10.1049/ir:20030904.
- [48] Eink. *SC001221*. <https://media.digikey.com/pdf/Data\%20Sheets/E\%20Ink\%20PDFs/SC001221.pdf>. 2017.
- [49] Yahoo! Finance, ed. *Global Wearable Electronics Industry*. [Online; posted 24-January-2020]. URL: <https://finance.yahoo.com/news/global-wearable-electronics-industry-142000794.html>.
- [50] Jutta Fortmann et al. “WaterJewel: design and evaluation of a bracelet to promote a better drinking behaviour”. In: *Proceedings of the 13th international conference on mobile and ubiquitous multimedia*. 2014, pp. 58–67.
- [51] Masaaki Fukumoto and Yasuhito Suenaga. ““FingeRing”: a full-time wearable interface”. In: *Proceedings of the SIGCHI Conference on Human Factors in Computing Systems*. CHI '94. Boston, MA, USA: ACM, 1994, pp. 81–82. ISBN: 0-89791-651-4. DOI: 10.1145/259963.260056. URL: <http://doi.acm.org/10.1145/259963.260056>.
- [52] Yulia Galagan et al. “ITO-free flexible organic solar cells with printed current collecting grids”. In: *Solar Energy Materials and Solar Cells* 95.5 (2011), pp. 1339–1343.

- [53] David T. Gallant, Andrew G. Seniuk, and Roel Vertegaal. “Towards More Paper-like Input: Flexible Input Devices for Foldable Interaction Styles”. In: *Proceedings of the 21st Annual ACM Symposium on User Interface Software and Technology*. UIST '08. Monterey, CA, USA: Association for Computing Machinery, 2008, pp. 283–286. ISBN: 9781595939753. DOI: 10.1145/1449715.1449762. URL: <https://doi.org/10.1145/1449715.1449762>.
- [54] Francine Gemperle et al. “Design for wearability”. In: *digest of papers. Second international symposium on wearable computers (cat. No. 98EX215)*. IEEE. 1998, pp. 116–122.
- [55] Warren M Grill and Clayton L Van Doren. “Detection of object contact during grasp using nail-mounted strain sensors”. In: *Engineering in Medicine and Biology Society, 1997. Proceedings of the 19th Annual International Conference of the IEEE*. Vol. 5. IEEE. 1997, pp. 1952–1953.
- [56] Tobias Grosse-Puppenthal et al. “Exploring the Design Space for Energy-Harvesting Situated Displays”. In: *Proceedings of the 29th Annual Symposium on User Interface Software and Technology*. UIST '16. Tokyo, Japan: ACM, 2016, pp. 41–48. ISBN: 978-1-4503-4189-9. DOI: 10.1145/2984511.2984513. URL: <http://dl.acm.org/citation.cfm?id=2984513>.
- [57] Richard K Gurgel and Clough Shelton. “The SoundBite hearing system: Patient-assessed safety and benefit study”. In: *The Laryngoscope* 123.11 (2013), pp. 2807–2812.
- [58] Antal Haans and Wijnand IJsselsteijn. “Mediated social touch: a review of current research and future directions”. In: *Virtual Reality* 9.2-3 (2006), pp. 149–159.
- [59] Lars Hallnäs and Johan Redström. “Slow technology—designing for reflection”. In: *Personal and ubiquitous computing* 5.3 (2001), pp. 201–212.
- [60] Mallory L Hammock et al. “25th anniversary article: the evolution of electronic skin (e-skin): a brief history, design considerations, and recent progress”. In: *Advanced materials* 25.42 (2013), pp. 5997–6038.
- [61] Rebecca Hansson and Peter Ljungstrand. “The reminder bracelet: subtle notification cues for mobile devices”. In: *CHI'00 Extended Abstracts on Human Factors in Computing Systems*. 2000, pp. 323–324.
- [62] Chris Harrison and Haakon Faste. “Implications of Location and Touch for On-Body Projected Interfaces”. In: *Proceedings of the 2014 Conference on Designing Interactive Systems*. DIS '14. Vancouver, BC, Canada: Association for Computing Machinery, 2014, pp. 543–552. ISBN: 9781450329026. DOI: 10.1145/2598510.2598587. URL: <https://doi.org/10.1145/2598510.2598587>.

- [63] Chris Harrison et al. “Where to Locate Wearable Displays? Reaction Time Performance of Visual Alerts from Tip to Toe”. In: *Proceedings of the SIGCHI Conference on Human Factors in Computing Systems*. CHI '09. Boston, MA, USA: Association for Computing Machinery, 2009, pp. 941–944. ISBN: 9781605582467. DOI: 10.1145/1518701.1518845. URL: <https://doi.org/10.1145/1518701.1518845>.
- [64] Lauren Hayes and Jessica Rajko. “Towards an Aesthetics of Touch”. In: *Proceedings of the 4th International Conference on Movement Computing*. MOCO '17. London, United Kingdom: Association for Computing Machinery, 2017. ISBN: 9781450352093. DOI: 10.1145/3077981.3078028. URL: <https://doi.org/10.1145/3077981.3078028>.
- [65] Stacey Higginbotham. *The Internet of Trash: IoT Has a Looming E-Waste Problem*. May 2018. URL: <https://spectrum.ieee.org/telecom/internet/the-internet-of-trash-iot-has-a-looming-ewaste-problem>.
- [66] Mads Hoby. *Touche for Arduino: Advanced Touch Sensing*. Ed. by instructables.com. 2012. URL: <http://www.instructables.com/id/Touche-for-Arduino-Advanced-touch-sensing/>.
- [67] Paul Holleis et al. “Evaluating Capacitive Touch Input on Clothes”. In: *Proceedings of the 10th International Conference on Human Computer Interaction with Mobile Devices and Services*. MobileHCI '08. Amsterdam, The Netherlands: Association for Computing Machinery, 2008, pp. 81–90. ISBN: 9781595939524. DOI: 10.1145/1409240.1409250. URL: <https://doi.org/10.1145/1409240.1409250>.
- [68] Peter J Houghton. “The scientific basis for the reputed activity of Valerian”. In: *Journal of Pharmacy and Pharmacology* 51.5 (1999), pp. 505–512.
- [69] Noura Howell et al. “Biosignals as Social Cues: Ambiguity and Emotional Interpretation in Social Displays of Skin Conductance”. In: *Proceedings of the 2016 ACM Conference on Designing Interactive Systems*. DIS '16. Brisbane, QLD, Australia: ACM, 2016, pp. 865–870. ISBN: 978-1-4503-4031-1. DOI: 10.1145/2901790.2901850. URL: <http://doi.acm.org/10.1145/2901790.2901850>.
- [70] Noura Howell et al. “Tensions of Data-Driven Reflection: A Case Study of Real-Time Emotional Biosensing”. In: *Proceedings of the 2018 CHI Conference on Human Factors in Computing Systems*. CHI '18. Montreal QC, Canada: ACM, 2018, 431:1–431:13. ISBN: 978-1-4503-5620-6. DOI: 10.1145/3173574.3174005. URL: <http://doi.acm.org/10.1145/3173574.3174005>.
- [71] Meng-Ju Hsieh, Rong-Hao Liang, and Bing-Yu Chen. “NailFactors: eyes-free spatial output using a nail-mounted tactor array”. In: *Proceedings of the 18th International Conference on Human-Computer Interaction with Mobile Devices and Services*. ACM. 2016, pp. 29–34.

- [72] Min-Chieh Hsiu et al. “Nail+: sensing fingernail deformation to detect finger force touch interactions on rigid surfaces”. In: *Proceedings of the 18th International Conference on Human-Computer Interaction with Mobile Devices and Services*. ACM, 2016, pp. 1–6.
- [73] <https://www.co.pierce.wa.us/>, ed. *Pathophysiology of thermal burn injury*. [Online; posted 21-Nov-2012]. Nov. 2012. URL: <https://www.co.pierce.wa.us/documentcenter/view/3352>.
- [74] Xian Huang et al. “Materials and designs for wireless epidermal sensors of hydration and strain”. In: *Advanced Functional Materials* 24.25 (2014), pp. 3846–3854.
- [75] Xian Huang et al. “Epidermal differential impedance sensor for conformal skin hydration monitoring”. In: *Biointerphases* 7.1 (2012), p. 52.
- [76] Da-Yuan Huang et al. “TouchSense: Expanding Touchscreen Input Vocabulary Using Different Areas of Users’ Finger Pads”. In: *Proceedings of the SIGCHI Conference on Human Factors in Computing Systems*. CHI ’14. Toronto, Ontario, Canada: ACM, 2014, pp. 189–192. ISBN: 978-1-4503-2473-1. DOI: 10.1145/2556288.2557258. URL: <http://doi.acm.org/10.1145/2556288.2557258>.
- [77] Sungjae Hwang et al. “NailSense: fingertip force as a new input modality”. In: *Proceedings of the adjunct publication of the 26th annual ACM symposium on User interface software and technology*. ACM, 2013, pp. 63–64.
- [78] Pradthana Jarusriboonchai and Jonna Häkkinä. “Customisable Wearables: Exploring the Design Space of Wearable Technology”. In: *Proceedings of the 18th International Conference on Mobile and Ubiquitous Multimedia*. MUM ’19. Pisa, Italy: Association for Computing Machinery, 2019. ISBN: 9781450376242. DOI: 10.1145/3365610.3365635. URL: <https://doi.org/10.1145/3365610.3365635>.
- [79] Walther Jensen et al. “TransPrint: A Method for Fabricating Flexible Transparent Free-Form Displays”. In: *Advances in Human-Computer Interaction 2019* (May 2019), pp. 1–14. DOI: 10.1155/2019/1340182.
- [80] Philip N. Johnson-Laird. *Mental models : towards a cognitive science of language, inference, and consciousness*. Excerpts available on Google Books. Cambridge, MA: Harvard University Press, 1983, 528 p. URL: <https://hal.archives-ouvertes.fr/hal-00702919>.
- [81] John Chris Jones. *Design methods*. John Wiley & Sons, 1992.
- [82] Oskar Juhlin. “Digitizing fashion: software for wearable devices”. In: *Interactions* 22.3 (2015), pp. 44–47.
- [83] Hsin-Liu (Cindy) Kao. “Hybrid Body Craft”. In: *Proceedings of the 2017 ACM Conference Companion Publication on Designing Interactive Systems*. DIS ’17 Companion. Edinburgh, United Kingdom: ACM, 2017, pp. 391–392. ISBN: 978-1-4503-4991-8. DOI: 10.1145/3064857.3079167. URL: <http://doi.acm.org/10.1145/3064857.3079167>.

- [84] Hsin-Liu (Cindy) Kao et al. “ChromoSkin: Towards Interactive Cosmetics Using Thermochromic Pigments”. In: *Proceedings of the 2016 CHI Conference Extended Abstracts on Human Factors in Computing Systems*. CHI EA '16. Santa Clara, California, USA: ACM, 2016, pp. 3703–3706. ISBN: 978-1-4503-4082-3. DOI: 10.1145/2851581.2890270. URL: <http://doi.acm.org/10.1145/2851581.2890270>.
- [85] Hsin-Liu (Cindy) Kao et al. “DuoSkin: rapidly prototyping on-skin user interfaces using skin-friendly materials”. In: *Proceedings of the 2016 ACM International Symposium on Wearable Computers*. ISWc '16. Heidelberg, Germany: ACM, 2016, pp. 16–23. ISBN: 978-1-4503-4460-9. DOI: 10.1145/2971763.2971777. URL: <http://doi.acm.org/10.1145/2971763.2971777>.
- [86] Hsin-Liu (Cindy) Kao et al. “EarthTones: Chemical Sensing Powders to Detect and Display Environmental Hazards through Color Variation”. In: *Proceedings of the 2017 CHI Conference Extended Abstracts on Human Factors in Computing Systems*. CHI EA '17. Denver, Colorado, USA: ACM, 2017, pp. 872–883. ISBN: 978-1-4503-4656-6. DOI: 10.1145/3027063.3052754. URL: <http://dl.acm.org/citation.cfm?id=3052754>.
- [87] Hsin-Liu (Cindy) Kao et al. “Exploring Interactions and Perceptions of Kinetic Wearables”. In: *Proceedings of the 2017 Conference on Designing Interactive Systems*. DIS '17. Edinburgh, United Kingdom: ACM, 2017, pp. 391–396. ISBN: 978-1-4503-4922-2. DOI: 10.1145/3064663.3064686. URL: <http://doi.acm.org/10.1145/3064663.3064686>.
- [88] Hsin-Liu (Cindy) Kao et al. “NailO: Fingernails as an Input Surface”. In: *Proceedings of the 33rd Annual ACM Conference on Human Factors in Computing Systems*. CHI '15. Seoul, Republic of Korea: ACM, 2015, pp. 3015–3018. ISBN: 978-1-4503-3145-6. DOI: 10.1145/2702123.2702572. URL: <http://doi.acm.org/10.1145/2702123.2702572>.
- [89] Hsin-Liu Kao et al. “Skinmorph: texture-tunable on-skin interface through thin, programmable gel”. In: *Proceedings of the 2018 ACM International Symposium on Wearable Computers*. 2018, pp. 196–203.
- [90] Arnav Kapur, Shreyas Kapur, and Pattie Maes. “AlterEgo: A Personalized Wearable Silent Speech Interface”. In: *23rd International Conference on Intelligent User Interfaces*. IUI '18. Tokyo, Japan: ACM, 2018, pp. 43–53. ISBN: 978-1-4503-4945-1. DOI: 10.1145/3172944.3172977. URL: <http://doi.acm.org/10.1145/3172944.3172977>.
- [91] Thorsten Karrer et al. “Pinstripe: Eyes-Free Continuous Input on Interactive Clothing”. In: *Proceedings of the SIGCHI Conference on Human Factors in Computing Systems*. CHI '11. Vancouver, BC, Canada: Association for Computing Machinery, 2011, pp. 1313–1322. ISBN: 9781450302289. DOI: 10.1145/1978942.1979137. URL: <https://doi.org/10.1145/1978942.1979137>.

- [92] Norene Kelly. “All the World’s a Stage: What Makes a Wearable Socially Acceptable”. In: *Interactions* 24.6 (Oct. 2017), pp. 56–60. ISSN: 1072-5520. DOI: 10.1145/3137093. URL: <https://doi.org/10.1145/3137093>.
- [93] Dae-Hyeong Kim et al. “Epidermal electronics”. In: *Science* 333.6044 (2011), pp. 838–843.
- [94] Jayong Kim et al. “A wearable fingernail chemical sensing platform: pH sensing at your fingertips”. In: *Talanta* 150 (Apr. 2016), pp. 622–628. URL: <http://dx.doi.org/10.1016/j.talanta.2015.12.083>.
- [95] KwanMyung Kim, Dongwoo Joo, and Kun-Pyo Lee. “Wearable-object-based Interaction for a Mobile Audio Device”. In: *CHI ’10 Extended Abstracts on Human Factors in Computing Systems*. CHI EA ’10. Atlanta, Georgia, USA: ACM, 2010, pp. 3865–3870. ISBN: 978-1-60558-930-5. DOI: 10.1145/1753846.1754070. URL: <http://doi.acm.org/10.1145/1753846.1754070>.
- [96] Nockhwan Kim et al. “Smart wig for patient with chemotherapy induced alopecia: emphasis on fall detection and emergency alert”. In: *Proceedings of HCI Korea*. HCIK ’15. Seoul, Republic of Korea: Hanbit Media, Inc., 2015, pp. 246–252. ISBN: 978-89-6848-752-1. URL: <http://dl.acm.org/citation.cfm?id=2729522>.
- [97] Yong Hyun Kim et al. “Achieving high efficiency and improved stability in ITO-free transparent organic light-emitting diodes with conductive polymer electrodes”. In: *Advanced Functional Materials* 23.30 (2013), pp. 3763–3769.
- [98] Scott R. Klemmer, Björn Hartmann, and Leila Takayama. “How Bodies Matter: Five Themes for Interaction Design”. In: *Proceedings of the 6th Conference on Designing Interactive Systems*. DIS ’06. University Park, PA, USA: Association for Computing Machinery, 2006, pp. 140–149. ISBN: 1595933670. DOI: 10.1145/1142405.1142429. URL: <https://doi.org/10.1145/1142405.1142429>.
- [99] Christian Kray et al. “User-defined Gestures for Connecting Mobile Phones, Public Displays, and Tabletops”. In: *Proceedings of the 12th International Conference on Human Computer Interaction with Mobile Devices and Services*. MobileHCI ’10. Lisbon, Portugal: ACM, 2010, pp. 239–248. ISBN: 978-1-60558-835-3. DOI: 10.1145/1851600.1851640. URL: <http://doi.acm.org/10.1145/1851600.1851640>.
- [100] Siddharth Krishnan et al. “Multimodal epidermal devices for hydration monitoring”. In: *Microsystems & nanoengineering* 3.1 (2017), pp. 1–11.
- [101] Vikas Kumar. “Implantable RFID chips”. In: *IFIP International Summer School on the Future of Identity in the Information Society*. Springer. 2007, pp. 151–157.
- [102] John Kymissis et al. “Parasitic Power Harvesting in Shoes”. In: *Proceedings of the 2nd IEEE International Symposium on Wearable Computers*. ISWC ’98. Pittsburgh, PA, USA: IEEE Computer Society, 1998, p. 132. ISBN: 0-8186-9074-7. URL: <http://dl.acm.org/citation.cfm?id=858024>.

- [103] Bruno Latour. “On Technical Mediation”. In: *Common Knowledge* 3.2 (1994), pp. 29–64.
- [104] Jenni Lauwrens. “Touch as an aesthetic experience”. In: *Journal of Visual Art Practice* (2019), pp. 1–19.
- [105] *LED Matrix Face Mask*. URL: <http://www.lumencouture.com/buy-led-light-up-dresses/shop-tech-warning-face-mask/>.
- [106] Johnny C. Lee, Scott E. Hudson, and Edward Tse. “Foldable Interactive Displays”. In: *Proceedings of the 21st Annual ACM Symposium on User Interface Software and Technology*. UIST '08. Monterey, CA, USA: Association for Computing Machinery, 2008, pp. 287–290. ISBN: 9781595939753. DOI: 10.1145/1449715.1449763. URL: <https://doi.org/10.1145/1449715.1449763>.
- [107] Sang-won Leigh et al. “Body-Borne Computers as Extensions of Self”. In: 6 (Mar. 2017), p. 12.
- [108] Sarah Leon. *Flat Iron Tips: How To Straighten Your Hair Without Damage*. Ed. by huffingtonpost.com. [Online; posted 3-May-2012]. May 2012. URL: http://www.huffingtonpost.com/2012/03/05/flat-iron-tips_n_1316212.html.
- [109] *Levi's Commuter Trucker Jacket with Jacquard by Google to Debut*. May 2019. URL: <http://www.levistrauss.com/unzipped-blog/2017/09/25/levis-commuter-trucker-jacket-jacquard-google/>.
- [110] Bing Li et al. “LightingHair Slice: Situated Personal Wearable Fashion Interaction System”. In: *Proceedings of the 2017 CHI Conference Extended Abstracts on Human Factors in Computing Systems*. CHI EA '17. Denver, Colorado, USA: ACM, 2017, pp. 1824–1828. ISBN: 978-1-4503-4656-6. DOI: 10.1145/3027063.3053093. URL: <http://dl.acm.org/citation.cfm?id=3053093>.
- [111] Richard Li, Jason Wu, and Thad Starner. “TongueBoard: An Oral Interface for Subtle Input”. In: *Proceedings of the 10th Augmented Human International Conference 2019*. AH2019. Reims, France: Association for Computing Machinery, 2019. ISBN: 9781450365475. DOI: 10.1145/3311823.3311831. URL: <https://doi.org/10.1145/3311823.3311831>.
- [112] Darren J Lipomi et al. “Electronic properties of transparent conductive films of PEDOT: PSS on stretchable substrates”. In: *Chemistry of Materials* 24.2 (2012), pp. 373–382.
- [113] Jiayang Liu et al. “uWave: Accelerometer-based personalized gesture recognition and its applications”. In: *2009 IEEE International Conference on Pervasive Computing and Communications* (2009). DOI: 10.1109/percom.2009.4912759.

- [114] Joanne Lo et al. “Aesthetic Electronics: Designing, Sketching, and Fabricating Circuits through Digital Exploration”. In: *Proceedings of the 29th Annual Symposium on User Interface Software and Technology*. UIST '16. Tokyo, Japan: Association for Computing Machinery, 2016, pp. 665–676. ISBN: 9781450341899. DOI: 10.1145/2984511.2984579. URL: <https://doi.org/10.1145/2984511.2984579>.
- [115] Joanne Lo et al. “Skintillates: Designing and Creating Epidermal Interactions”. In: *Proceedings of the 2016 ACM Conference on Designing Interactive Systems*. DIS '16. Brisbane, QLD, Australia: ACM, 2016, pp. 853–864. ISBN: 978-1-4503-4031-1. DOI: 10.1145/2901790.2901885. URL: <http://doi.acm.org/10.1145/2901790.2901885>.
- [116] Jennifer Mankoff et al. “Heuristic Evaluation of Ambient Displays”. In: *Proceedings of the SIGCHI Conference on Human Factors in Computing Systems*. CHI '03. Ft. Lauderdale, Florida, USA: ACM, 2003, pp. 169–176. ISBN: 1-58113-630-7. DOI: 10.1145/642611.642642. URL: <http://doi.acm.org/10.1145/642611.642642>.
- [117] Alexandre Marain. *Why this Louis Vuitton by Virgil Abloh bag already has a cult online following*. May 2019. URL: <https://www.vogue.fr/vogue-hommes-en/article/why-this-louis-vuitton-by-virgil-abloh-bag-already-has-a-cult-online-following>.
- [118] Alex Mariakakis et al. “Project Calico: Wearable Chemical Sensors for Environmental Monitoring”. In: *arXiv preprint arXiv:2006.15292* (2020).
- [119] Eric Markvicka et al. “ElectroDermis: Fully Untethered, Stretchable, and Highly-Customizable Electronic Bandages”. In: *Proceedings of the 2019 CHI Conference on Human Factors in Computing Systems*. CHI '19. Glasgow, Scotland Uk: ACM, 2019, 632:1–632:10. ISBN: 978-1-4503-5970-2. DOI: 10.1145/3290605.3300862. URL: <http://doi.acm.org/10.1145/3290605.3300862>.
- [120] Stephen A Mascaro and H Harry Asada. “Photoplethysmograph fingernail sensors for measuring finger forces without haptic obstruction”. In: *IEEE Transactions on robotics and automation* 17.5 (2001), pp. 698–708.
- [121] Stephen Mascaro and H Harry Asada. “Finger posture and shear force measurement using fingernail sensors: Initial experimentation”. In: *Robotics and Automation, 2001. Proceedings 2001 ICRA. IEEE International Conference on*. Vol. 2. IEEE. 2001, pp. 1857–1862.
- [122] Dan Mauney et al. “Cultural Similarities and Differences in User-defined Gestures for Touchscreen User Interfaces”. In: *CHI '10 Extended Abstracts on Human Factors in Computing Systems*. CHI EA '10. Atlanta, Georgia, USA: ACM, 2010, pp. 4015–4020. ISBN: 978-1-60558-930-5. DOI: 10.1145/1753846.1754095. URL: <http://doi.acm.org/10.1145/1753846.1754095>.
- [123] Timothy P McNamara. *Semantic priming: Perspectives from memory and word recognition*. Psychology Press, 2005.

- [124] Deb Miller Landau. *Smart Gloves from ProGlove Let Your Fingers do the Talking*. Ed. by intel.com. [Online; posted 20-October-2014]. Oct. 2014. URL: <https://iq.intel.com/smart-gloves-let-fingers-talking/>.
- [125] Cameron S. Miner, Denise M. Chan, and Christopher Campbell. “Digital Jewelry: Wearable Technology for Everyday Life”. In: *CHI '01 Extended Abstracts on Human Factors in Computing Systems*. CHI EA '01. Seattle, Washington: ACM, 2001, pp. 45–46. ISBN: 1-58113-340-5. DOI: 10.1145/634067.634098. URL: <http://doi.acm.org/10.1145/634067.634098>.
- [126] *Mirror Handbag*. URL: <https://shop.cutecircuit.com/collections/accessories/products/mirror-handbag>.
- [127] Pranav Mistry and Pattie Maes. “SixthSense: A Wearable Gestural Interface”. In: *ACM SIGGRAPH ASIA 2009 Sketches*. SIGGRAPH ASIA '09. Yokohama, Japan: ACM, 2009, 11:1–11:1. DOI: 10.1145/1667146.1667160. URL: <http://doi.acm.org/10.1145/1667146.1667160>.
- [128] Pranav Mistry, Pattie Maes, and Liyan Chang. “WUW - Wear Ur World: A Wearable Gestural Interface”. In: *CHI '09 Extended Abstracts on Human Factors in Computing Systems*. CHI EA '09. Boston, MA, USA: ACM, 2009, pp. 4111–4116. ISBN: 978-1-60558-247-4. DOI: 10.1145/1520340.1520626. URL: <http://doi.acm.org/10.1145/1520340.1520626>.
- [129] Pranav Mistry, Suranga Nanayakkara, and Pattie Maes. “Touch and Copy, Touch and Paste”. In: *CHI '11 Extended Abstracts on Human Factors in Computing Systems*. CHI EA '11. Vancouver, BC, Canada: ACM, 2011, pp. 1095–1098. ISBN: 978-1-4503-0268-5. DOI: 10.1145/1979742.1979714. URL: <http://doi.acm.org/10.1145/1979742.1979714>.
- [130] Desmond Morris. *Peopewatching: The Desmond Morris Guide to Body Language*. Random House, Nov. 2012. ISBN: 9781407071497. URL: https://books.google.com/books?id=8B_1PfLTDcMC.
- [131] Meredith Ringel Morris et al. “Reducing Legacy Bias in Gesture Elicitation Studies”. In: *interactions* 21.3 (May 2014), pp. 40–45. ISSN: 1072-5520. DOI: 10.1145/2591689. URL: <http://doi.acm.org/10.1145/2591689>.
- [132] Heiko Müller et al. “Using electrochromic displays to display ambient information and notifications”. In: *Adjunct Proceedings of the 2019 ACM International Joint Conference on Pervasive and Ubiquitous Computing and Proceedings of the 2019 ACM International Symposium on Wearable Computers*. 2019, pp. 1075–1078.
- [133] PR Newswire, ed. *World Market for Wearable Devices, Set to Reach \$62.82 Billion by 2025 - Increasing Penetration of IoT Related Devices Drives Market Growth*. [Online; posted 13-December-2019]. URL: <https://www.prnewswire.com/news-releases/world-market-for-wearable-devices-set-to-reach-62-82-billion-by->

- 2025---increasing-penetration-of-iot--related-devices-drives-market-growth-300974593.html.
- [134] Phuc Nguyen et al. “TYTH-Typing On Your Teeth: Tongue-Teeth Localization for Human-Computer Interface”. In: *Proceedings of the 16th Annual International Conference on Mobile Systems, Applications, and Services*. MobiSys '18. Munich, Germany: Association for Computing Machinery, 2018, pp. 269–282. ISBN: 9781450357203. DOI: 10.1145/3210240.3210322. URL: <https://doi.org/10.1145/3210240.3210322>.
- [135] Aditya Shekhar Nittala et al. “Multi-Touch Skin: A Thin and Flexible Multi-Touch Sensor for On-Skin Input”. In: *Proceedings of the 2018 CHI Conference on Human Factors in Computing Systems*. CHI '18. Montreal QC, Canada: Association for Computing Machinery, 2018. ISBN: 9781450356206. DOI: 10.1145/3173574.3173607. URL: <https://doi.org/10.1145/3173574.3173607>.
- [136] Don Norman. *The design of everyday things: Revised and expanded edition*. Constellation, 2013.
- [137] Lauren K. Ohnesorge. *The latest weapon in the fight against date rape drugs? Nail polish*. Ed. by bizjournals.com. [Online; posted 26-August-2014]. Aug. 2014. URL: <http://www.bizjournals.com/triangle/bizwomen/news/out-of-the-office/2014/08/the-latest-weapon-in-the-fight-against-daterape.html>.
- [138] Simon Olberding, Michael Wessely, and Jürgen Steimle. “PrintScreen: Fabricating Highly Customizable Thin-film Touch-displays”. In: *Proceedings of the 27th Annual ACM Symposium on User Interface Software and Technology*. UIST '14. Honolulu, Hawaii, USA: ACM, 2014, pp. 281–290. ISBN: 978-1-4503-3069-5. DOI: 10.1145/2642918.2647413. URL: <http://doi.acm.org/10.1145/2642918.2647413>.
- [139] Maggie Orth, Rehmi Post, and Emily Cooper. “Fabric computing interfaces”. In: *CHI 98 conference summary on Human factors in computing systems*. 1998, pp. 331–332.
- [140] Heun Park et al. “A skin-integrated transparent and stretchable strain sensor with interactive color-changing electrochromic displays”. In: *Nanoscale* 9.22 (2017), pp. 7631–7640.
- [141] Aaron N. Parks et al. “A Wireless Sensing Platform Utilizing Ambient RF Energy”. In: *Proceedings of the 2nd annual IEEE International Radio and Wireless Symposium*. RWS '13. Austin, TX, USA: IEEE Computer Society, 2013, pp. 331–333. ISBN: 978-1-4673-2932-3. DOI: 10.1109/RWS.2013.6486731. URL: <http://ieeexplore.ieee.org/document/6486731/>.
- [142] Stéphanie Pasche et al. “Wearable biosensors for monitoring wound healing”. In: *Advances in Science and Technology*. Vol. 57. Trans Tech Publ. 2008, pp. 80–87.
- [143] Eric Paulos. *Energy Parasites*. 2012. URL: <http://www.energyparasites.net/>.

- [144] Jennifer Pearson, Simon Robinson, and Matt Jones. “It’s About Time: Smartwatches As Public Displays”. In: *Proceedings of the 33rd Annual ACM Conference on Human Factors in Computing Systems*. CHI ’15. Seoul, Republic of Korea: ACM, 2015, pp. 1257–1266. ISBN: 978-1-4503-3145-6. DOI: 10.1145/2702123.2702247. URL: <http://doi.acm.org/10.1145/2702123.2702247>.
- [145] J.K. Perng et al. “Acceleration sensing glove (ASG)”. In: *Digest of Papers. Third International Symposium on Wearable Computers* (). DOI: 10.1109/iswc.1999.806717.
- [146] James Pierce and Eric Paulos. “Making multiple uses of the obscure 1C digital camera: reflecting on the design, production, packaging and distribution of a counterfunctional device”. In: *Proceedings of the 33rd Annual ACM Conference on Human Factors in Computing Systems*. 2015, pp. 2103–2112.
- [147] James Pierce and Eric Paulos. “Materializing Energy”. In: *Proceedings of the 8th ACM Conference on Designing Interactive Systems*. DIS ’10. Aarhus, Denmark: ACM, 2010, pp. 113–122. ISBN: 978-1-4503-0103-9. DOI: 10.1145/1858171.1858193. URL: <http://doi.acm.org/10.1145/1858171.1858193>.
- [148] Rafael Pires-Oliveira et al. “Specific heat capacity of cosmetically treated human hair”. In: *Proceedings of the 22nd Conference of the International Federation of the Societies of Cosmetic Chemists*. IFSCC ’13. Rio de Janeiro, Brazil, 2013, p. 3. URL: https://www.researchgate.net/publication/266454223_Specific_heat_capacity_of_cosmetically_treated_human_hair.
- [149] Thammathip Piumsomboon et al. “User-defined Gestures for Augmented Reality”. In: *CHI ’13 Extended Abstracts on Human Factors in Computing Systems*. CHI EA ’13. Paris, France: ACM, 2013, pp. 955–960. ISBN: 978-1-4503-1952-2. DOI: 10.1145/2468356.2468527. URL: <http://doi.acm.org/10.1145/2468356.2468527>.
- [150] Michael Polanyi. *The tacit dimension*. University of Chicago press, 2009.
- [151] E. Rehmi Post and Margaret Orth. “Smart Fabric, or ”Wearable Clothing””. In: *Proceedings of the 1st IEEE International Symposium on Wearable Computers*. ISWC ’97. Washington, DC, USA: IEEE Computer Society, 1997, pp. 167–. ISBN: 0-8186-8192-6. URL: <http://dl.acm.org/citation.cfm?id=851036.856432>.
- [152] Ernest Rehmatulla Post et al. “E-broidery: Design and fabrication of textile-based computing”. In: *IBM Systems journal* 39.3.4 (2000), pp. 840–860.
- [153] Ivan Poupyrev et al. “Project Jacquard: Interactive Digital Textiles at Scale”. In: *Proceedings of the 2016 CHI Conference on Human Factors in Computing Systems*. CHI ’16. Santa Clara, California, USA: ACM, 2016, pp. 4216–4227. ISBN: 978-1-4503-3362-7. DOI: 10.1145/2858036.2858176. URL: <http://doi.acm.org/10.1145/2858036.2858176>.
- [154] Arthur Prochazka. *Method and apparatus for controlling a device or process with vibrations generated by tooth clicks*. US Patent 6,961,623. Nov. 2005.

- [155] Halley P. Profita et al. “Don’t Mind Me Touching My Wrist: A Case Study of Interacting with on-Body Technology in Public”. In: *Proceedings of the 2013 International Symposium on Wearable Computers*. ISWC ’13. Zurich, Switzerland: Association for Computing Machinery, 2013, pp. 89–96. ISBN: 9781450321273. DOI: 10.1145/2493988.2494331. URL: <https://doi.org/10.1145/2493988.2494331>.
- [156] Halley Profita, Asta Roseway, and Mary Czerwinski. “Lightwear: An Exploration in Wearable Light Therapy”. In: *Proceedings of the Ninth International Conference on Tangible, Embedded, and Embodied Interaction*. TEI ’15. Stanford, California, USA: ACM, 2015, pp. 321–328. ISBN: 978-1-4503-3305-4. DOI: 10.1145/2677199.2680573. URL: <http://doi.acm.org/10.1145/2677199.2680573>.
- [157] Luisa von Radziewsky, Antonio Krüger, and Markus Löchtefeld. “Scarfy: augmenting human fashion behaviour with self-actuated clothes”. In: *Proceedings of the Ninth International Conference on Tangible, Embedded, and Embodied Interaction*. 2015, pp. 313–316.
- [158] Isabel Benavente Rodriguez and Nicolai Marquardt. “Gesture Elicitation Study on How to Opt-in & Opt-out from Interactions with Public Displays”. In: *Proceedings of the 2017 ACM International Conference on Interactive Surfaces and Spaces*. ISS ’17. Brighton, United Kingdom: ACM, 2017, pp. 32–41. ISBN: 978-1-4503-4691-7. DOI: 10.1145/3132272.3134118. URL: <http://doi.acm.org/10.1145/3132272.3134118>.
- [159] Munehiko Sato, Ivan Poupyrev, and Chris Harrison. “Touché: enhancing touch interaction on humans, screens, liquids, and everyday objects”. In: *Proceedings of the SIGCHI Conference on Human Factors in Computing Systems*. CHI ’12. Austin, Texas, USA: ACM, 2012, pp. 483–492. ISBN: 978-1-4503-1015-4. DOI: 10.1145/2207676.2207743. URL: <http://doi.acm.org/10.1145/2207676.2207743>.
- [160] Paul Scherz and Simon Monk. *Practical electronics for inventors*. Vol. 29. McGraw-Hill New York, 2000.
- [161] Eldon Schoop, James Smith, and Bjoern Hartmann. “HindSight: Enhancing Spatial Awareness by Sonifying Detected Objects in Real-Time 360-Degree Video”. In: *Proceedings of the 2018 CHI Conference on Human Factors in Computing Systems*. CHI ’18. Montreal QC, Canada: ACM, 2018, 143:1–143:12. ISBN: 978-1-4503-5620-6. DOI: 10.1145/3173574.3173717. URL: <http://doi.acm.org/10.1145/3173574.3173717>.
- [162] Klaus Schroeder. “Gender dimensions of product design”. In: *Gender, Science, and Technology Expert Group meeting of the United Nations Division for the Advancement of Women (UN-DAW)*. Vol. 28. 2010, pp. 93–200.
- [163] Carsten Schwesig, Ivan Poupyrev, and Eijiro Mori. “Gummi: User Interface for Deformable Computers”. In: *CHI ’03 Extended Abstracts on Human Factors in Computing Systems*. CHI EA ’03. Ft. Lauderdale, Florida, USA: Association for Computing

- Machinery, 2003, pp. 954–955. ISBN: 1581136374. DOI: 10.1145/765891.766091. URL: <https://doi.org/10.1145/765891.766091>.
- [164] Ted Selker, Andrea Lockerd, and Jorge Martinez. “Eye-R, a Glasses-mounted Eye Motion Detection Interface”. In: *CHI '01 Extended Abstracts on Human Factors in Computing Systems*. CHI EA '01. Seattle, Washington: ACM, 2001, pp. 179–180. ISBN: 1-58113-340-5. DOI: 10.1145/634067.634176. URL: <http://doi.acm.org/10.1145/634067.634176>.
- [165] Teddy Seyed and Anthony Tang. “Mannequette: Understanding and Enabling Collaboration and Creativity on Avant-Garde Fashion-Tech Runways”. In: *Proceedings of the 2019 on Designing Interactive Systems Conference*. DIS '19. San Diego, CA, USA: Association for Computing Machinery, 2019, pp. 317–329. ISBN: 9781450358507. DOI: 10.1145/3322276.3322305. URL: <https://doi.org/10.1145/3322276.3322305>.
- [166] Teddy Seyed et al. “Eliciting Usable Gestures for Multi-display Environments”. In: *Proceedings of the 2012 ACM International Conference on Interactive Tabletops and Surfaces*. ITS '12. Cambridge, Massachusetts, USA: ACM, 2012, pp. 41–50. ISBN: 978-1-4503-1209-7. DOI: 10.1145/2396636.2396643. URL: <http://doi.acm.org/10.1145/2396636.2396643>.
- [167] Yulia Silina and Hamed Haddadi. “New Directions in Jewelry: A Close Look at Emerging Trends & Developments in Jewelry-like Wearable Devices”. In: *Proceedings of the 2015 ACM International Symposium on Wearable Computers*. ISWC '15. Osaka, Japan: ACM, 2015, pp. 49–56. ISBN: 978-1-4503-3578-2. DOI: 10.1145/2802083.2808410. URL: <http://doi.acm.org/10.1145/2802083.2808410>.
- [168] Dhananjay Singh, Gaurav Tripathi, and Antonio J Jara. “A survey of Internet-of-Things: Future vision, architecture, challenges and services”. In: *Internet of things (WF-IoT), 2014 IEEE world forum on*. IEEE. 2014, pp. 287–292.
- [169] Sheridan Martin Small and Asta Roseway. “The Printing Dress: You are what you Tweet”. In: (2011).
- [170] *Sonitus wireless communications systems for tactical applications*. URL: <http://www.sonitustechologies.com/tactical/>.
- [171] Thad Starner et al. “Augmented reality through wearable computing”. In: *Presence: Teleoperators and Virtual Environments* 6.4 (1997), pp. 386–398.
- [172] Karl D Stephan et al. “Social implications of technology: The past, the present, and the future”. In: *Proceedings of the IEEE* 100.Special Centennial Issue (2012), pp. 1752–1781.
- [173] Cary Stothart, Ainsley Mitchum, and Courtney Yehnert. “The attentional cost of receiving a cell phone notification.” In: *Journal of Experimental Psychology: Human Perception and Performance* 41.4 (2015), pp. 893–897. DOI: 10.1037/xhp0000100. URL: <http://dx.doi.org/10.1037/xhp0000100>.

- [174] Paul Strohmeier et al. “zPatch: Hybrid Resistive/Capacitive eTextile Input”. In: *Proceedings of the Twelfth International Conference on Tangible, Embedded, and Embodied Interaction*. TEI '18. Stockholm, Sweden: ACM, 2018, pp. 188–198. ISBN: 978-1-4503-5568-1. DOI: 10.1145/3173225.3173242. URL: <http://doi.acm.org/10.1145/3173225.3173242>.
- [175] Chao-Huai Su et al. “NailDisplay: bringing an always available visual display to fingertips”. In: *Proceedings of the SIGCHI Conference on Human Factors in Computing Systems*. CHI '13. Paris, France: ACM, 2013, pp. 1461–1464. ISBN: 978-1-4503-1899-0. DOI: 10.1145/2470654.2466193. URL: <http://doi.acm.org/10.1145/2470654.2466193>.
- [176] Ivan E. Sutherland. “A Head-mounted Three Dimensional Display”. In: *Proceedings of the December 9-11, 1968, Fall Joint Computer Conference, Part I*. AFIPS '68 (Fall, part I). San Francisco, California: ACM, 1968, pp. 757–764. DOI: 10.1145/1476589.1476686. URL: <http://doi.acm.org/10.1145/1476589.1476686>.
- [177] D. Sweeney et al. “Displays as a Material: A Route to Making Displays More Pervasive”. In: *IEEE Pervasive Computing* 15.3 (July 2016), pp. 77–82. ISSN: 1536-1268. DOI: 10.1109/MPRV.2016.56.
- [178] Anthony Synnott. “Shame and Glory: A Sociology of Hair”. English. In: *The British Journal of Sociology* 38.3 (1987), pp. 381–413. DOI: 10.2307/590695. URL: <http://www.jstor.org/stable/590695>.
- [179] Takara Tomy A.R.T.S. 2016. URL: <http://www.takaratomy-arts.co.jp/specials/lumideco/>.
- [180] Vamsi Talla et al. “Battery-Free Cellphone”. In: *Proceedings of the ACM on Interactive, Mobile, Wearable and Ubiquitous Technologies*. Vol. 1. IMWUT '17 25. New York, NY, USA: ACM, 2017. DOI: 10.1145/3090090. URL: <http://dl.acm.org/citation.cfm?id=3090090>.
- [181] *The Personal Space Dress*. June 2018. URL: <https://urbanarmor.org/portfolio/the-personal-space-dress/>.
- [182] Edward O Thorp. “The invention of the first wearable computer”. In: *Digest of Papers. Second international symposium on wearable computers (Cat. No. 98EX215)*. IEEE. 1998, pp. 4–8.
- [183] Hiroaki Tobita and Takuya Kuzi. “SmartWig: wig-based wearable computing device for communication and entertainment”. In: *Proceedings of the International Working Conference on Advanced Visual Interfaces*. AVI '12. Capri Island, Italy: ACM, 2012, pp. 299–302. ISBN: 978-1-4503-1287-5. DOI: 10.1145/2254556.2254613. URL: <http://doi.acm.org/10.1145/2254556.2254613>.
- [184] Aaron Toney et al. “Social weight: designing to minimise the social consequences arising from technology use by the mobile professional”. In: *Personal and Ubiquitous Computing* 7.5 (2003), pp. 309–320.

- [185] The Unseen, ed. *Fire*. Feb. 2017. URL: <http://seetheunseen.co.uk/collection-archive/f-i-r-e/>.
- [186] Radu-Daniel Vatavu and Jacob O. Wobbrock. “Formalizing Agreement Analysis for Elicitation Studies: New Measures, Significance Test, and Toolkit”. In: *Proceedings of the 33rd Annual ACM Conference on Human Factors in Computing Systems*. CHI ’15. Seoul, Republic of Korea: ACM, 2015, pp. 1325–1334. ISBN: 978-1-4503-3145-6. DOI: 10.1145/2702123.2702223. URL: <http://doi.acm.org/10.1145/2702123.2702223>.
- [187] Radu-Daniel Vatavu and Ionut-Alexandru Zaiti. “Leap Gestures for TV: Insights from an Elicitation Study”. In: *Proceedings of the ACM International Conference on Interactive Experiences for TV and Online Video*. TVX ’14. Newcastle Upon Tyne, United Kingdom: ACM, 2014, pp. 131–138. ISBN: 978-1-4503-2838-8. DOI: 10.1145/2602299.2602316. URL: <http://doi.acm.org/10.1145/2602299.2602316>.
- [188] Thorstein Veblen. *The Theory of the Leisure Class*. Macmillan, 1899.
- [189] Tomás Vega Gálvez et al. “Byte.It: Discreet Teeth Gestures for Mobile Device Interaction”. In: *Extended Abstracts of the 2019 CHI Conference on Human Factors in Computing Systems*. CHI EA ’19. Glasgow, Scotland Uk: Association for Computing Machinery, 2019, pp. 1–6. ISBN: 9781450359719. DOI: 10.1145/3290607.3312925. URL: <https://doi.org/10.1145/3290607.3312925>.
- [190] Katia Fabiola Canepa Vega, Patricia J. Flanagan, and Hugo Fuks. “Blinkliker: A Case Study for Prototyping Wearable Computers in Technology and Visual Arts”. In: *Design, User Experience, and Usability. User Experience in Novel Technological Environments*. DUXU ’13. Berlin, Heidelberg: Springer, 2013, pp. 439–445. ISBN: 978-3-642-39238-2. DOI: 10.1007/978-3-642-39238-2_4. URL: https://link.springer.com/chapter/10.1007/978-3-642-39238-2_48.
- [191] Katia Vega, Marcio Cunha, and Hugo Fuks. “Hairware: The Conscious Use of Unconscious Auto-contact Behaviors”. In: *Proceedings of the 20th International Conference on Intelligent User Interfaces*. IUI ’15. Atlanta, Georgia, USA: ACM, 2015, pp. 78–86. ISBN: 978-1-4503-3306-1. DOI: 10.1145/2678025.2701404. URL: <http://doi.acm.org/10.1145/2678025.2701404>.
- [192] Katia Vega and Hugo Fuks. “Beauty tech nails: interactive technology at your fingertips”. In: *Proceedings of the 8th International Conference on Tangible, Embedded and Embodied Interaction*. TEI ’14. Munich, Germany: ACM, 2014, pp. 61–64. ISBN: 978-1-4503-2635-3. DOI: 10.1145/2540930.2540961. URL: <http://doi.acm.org/10.1145/2540930.2540961>.
- [193] Katia Vega and Hugo Fuks. “Beauty Technology: Body Surface Computing”. In: *Computer* 47.4 (Apr. 2014), pp. 71–75. ISSN: 0018-9162. URL: <http://dx.doi.org/10.1109/MC.2014.81>.

- [194] Katia Vega et al. “FX e-Makeup for Muscle Based Interaction”. In: *Design, User Experience, and Usability. User Experience Design for Everyday Life Applications and Services*. DUXU '14. Berlin, Heidelberg: Springer, 2014, pp. 643–652. ISBN: 978-3-319-07635-5. DOI: 10.1007/978-3-319-07635-5_61. URL: https://link.springer.com/chapter/10.1007/978-3-319-07635-5_61.
- [195] Katia Vega et al. “The Dermal Abyss: Interfacing with the Skin by Tattooing Biosensors”. In: *Proceedings of the 2017 ACM International Symposium on Wearable Computers*. ISWC '17. Maui, Hawaii: Association for Computing Machinery, 2017, pp. 138–145. ISBN: 9781450351881. DOI: 10.1145/3123021.3123039. URL: <https://doi.org/10.1145/3123021.3123039>.
- [196] Maarten Versteeg, Elise van den Hoven, and Caroline Hummels. “Interactive Jewellery: A Design Exploration”. In: *Proceedings of the TEI '16: Tenth International Conference on Tangible, Embedded, and Embodied Interaction*. TEI '16. Eindhoven, Netherlands: Association for Computing Machinery, 2016, pp. 44–52. ISBN: 9781450335829. DOI: 10.1145/2839462.2839504. URL: <https://doi.org/10.1145/2839462.2839504>.
- [197] Tiina Vuorinen et al. “Inkjet-printed graphene/PEDOT: PSS temperature sensors on a skin-conformable polyurethane substrate”. In: *Scientific reports* 6 (2016), p. 35289.
- [198] Wouter Walmink, Alan Chatham, and Florian Mueller. “Lumahelm: An Interactive Helmet”. In: *CHI '13 Extended Abstracts on Human Factors in Computing Systems*. CHI EA '13. Paris, France: ACM, 2013, pp. 2847–2848. ISBN: 978-1-4503-1952-2. DOI: 10.1145/2468356.2479542. URL: <http://doi.acm.org/10.1145/2468356.2479542>.
- [199] Jeen-Shing Wang and Fang-Chen Chuang. “An Accelerometer-Based Digital Pen With a Trajectory Recognition Algorithm for Handwritten Digit and Gesture Recognition”. In: *IEEE Transactions on Industrial Electronics* 59.7 (2012), pp. 2998–3007. DOI: 10.1109/tie.2011.2167895.
- [200] Yanan Wang, Judith Amores, and Pattie Maes. “On-Face Olfactory Interfaces”. In: *Proceedings of the 2020 CHI Conference on Human Factors in Computing Systems*. 2020, pp. 1–9.
- [201] Yanan Wang et al. “AnimSkin: Fabricating Epidermis with Interactive, Functional and Aesthetic Color Animation”. In: *Proceedings of the 2017 Conference on Designing Interactive Systems*. DIS '17. Edinburgh, United Kingdom: ACM, 2017, pp. 397–401. ISBN: 978-1-4503-4922-2. DOI: 10.1145/3064663.3064687. URL: <http://doi.acm.org/10.1145/3064663.3064687>.
- [202] Yanan Wang et al. “SKIN+: Fabricating Soft Fluidic User Interfaces for Enhancing On-Skin Experiences and Interactions”. In: *Extended Abstracts of the 2018 CHI Conference on Human Factors in Computing Systems*. CHI EA '18. Montreal QC,

- Canada: Association for Computing Machinery, 2018. ISBN: 9781450356213. DOI: 10.1145/3170427.3188443. URL: <https://doi.org/10.1145/3170427.3188443>.
- [203] Suzi Webster. *Barking Mad*. URL: <http://www.suziwebster.org/barkingmad.html>.
- [204] Martin Weigel and Jürgen Steimle. “Fingernail Displays: Handy Displays at your Fingertips”. In: *In CHI '13 Extended Abstracts on Human Factors in Computing Systems*. CHI EA '13. Paris, France: ACM, 2013, pp. 937–942.
- [205] Martin Weigel et al. “iSkin: Flexible, Stretchable and Visually Customizable On-Body Touch Sensors for Mobile Computing”. In: *Proceedings of the 33rd Annual ACM Conference on Human Factors in Computing Systems*. CHI '15. Seoul, Republic of Korea: ACM, 2015, pp. 2991–3000. ISBN: 978-1-4503-3145-6. DOI: 10.1145/2702123.2702391. URL: <http://doi.acm.org/10.1145/2702123.2702391>.
- [206] Martin Weigel et al. “SkinMarks: Enabling Interactions on Body Landmarks Using Conformal Skin Electronics”. In: ACM Press, 2017, pp. 3095–3105. ISBN: 978-1-4503-4655-9. DOI: 10.1145/3025453.3025704. URL: <http://dl.acm.org/citation.cfm?doid=3025453.3025704> (visited on 08/09/2017).
- [207] Mark Weiser. “The computer for the 21st century”. In: *Scientific american* 265.3 (1991), pp. 94–104.
- [208] Robert S Weiss. *Learning from strangers: The art and method of qualitative interview studies*. Simon and Schuster, 1995.
- [209] Michael Wessely, Theophanis Tsandilas, and Wendy E. Mackay. “Stretchis: Fabricating Highly Stretchable User Interfaces”. In: *Proceedings of the 29th Annual Symposium on User Interface Software and Technology*. UIST '16. Tokyo, Japan: Association for Computing Machinery, 2016, pp. 697–704. ISBN: 9781450341899. DOI: 10.1145/2984511.2984521. URL: <https://doi.org/10.1145/2984511.2984521>.
- [210] Eric Whitmire et al. “DigiTouch: Reconfigurable Thumb-to-Finger Input and Text Entry on Head-mounted Displays”. In: *Proceedings of the ACM on Interactive, Mobile, Wearable and Ubiquitous Technologies* 1.3 (2017), p. 113.
- [211] wikihow.com, ed. *How to Chalk Dye Your Hair*. 2016. URL: <http://www.wikihow.com/Chalk-Dye-Your-Hair>.
- [212] Amanda Williams, Shelly Farnham, and Scott Counts. “Exploring wearable ambient displays for social awareness”. In: *CHI'06 extended abstracts on Human factors in computing systems*. 2006, pp. 1529–1534.
- [213] Michele A Williams et al. “Swarm: an actuated wearable for mediating affect”. In: *Proceedings of the Ninth International Conference on Tangible, Embedded, and Embodied Interaction*. 2015, pp. 293–300.

- [214] Raphael Wimmer and Florian Echtler. “Exploring the Benefits of Fingernail Displays”. In: *Extended Abstracts on Human Factors in Computing Systems*. CHI EA '13. Paris, France: ACM, 2013, pp. 937–942. ISBN: 978-1-4503-1952-2. DOI: 10.1145/2468356.2468524. URL: <http://doi.acm.org/10.1145/2468356.2468524>.
- [215] Anusha Withana, Daniel Groeger, and Jürgen Steimle. “Tacttoo: A Thin and Feel-Through Tattoo for On-Skin Tactile Output”. In: *Proceedings of the 31st Annual ACM Symposium on User Interface Software and Technology*. UIST '18. Berlin, Germany: Association for Computing Machinery, 2018, pp. 365–378. ISBN: 9781450359481. DOI: 10.1145/3242587.3242645. URL: <https://doi.org/10.1145/3242587.3242645>.
- [216] Jacob O. Wobbrock, Meredith Ringel Morris, and Andrew D. Wilson. “User-defined Gestures for Surface Computing”. In: *Proceedings of the SIGCHI Conference on Human Factors in Computing Systems*. CHI '09. Boston, MA, USA: ACM, 2009, pp. 1083–1092. ISBN: 978-1-60558-246-7. DOI: 10.1145/1518701.1518866. URL: <http://doi.acm.org/10.1145/1518701.1518866>.
- [217] Naomi Wolf. *The Beauty Myth*. Chatto & Windus, 1990. ISBN: 9780701134310. URL: <https://books.google.com/books?id=D0naAAAAMAAJ>.
- [218] Robert B Wood. “Holographic head-up displays”. In: *Electro-optical displays (1992)*, pp. 70–80.
- [219] Ruize Xu, Shengli Zhou, and Wen J Li. “MEMS accelerometer based nonspecific-user hand gesture recognition”. In: *IEEE sensors journal* 12.5 (2012), pp. 1166–1173.
- [220] Xing-Dong Yang et al. “Magic finger: always-available input through finger instrumentation”. In: *Proceedings of the 25th annual ACM symposium on User interface software and technology*. ACM. 2012, pp. 147–156.
- [221] Yiran Yang and Wei Gao. “Wearable and flexible electronics for continuous molecular monitoring”. In: *Chemical Society Reviews* 48.6 (2019), pp. 1465–1491.
- [222] Shanshan Yao et al. “A wearable hydration sensor with conformal nanowire electrodes”. In: *Advanced healthcare materials* 6.6 (2017), p. 1601159.
- [223] Shanhe Yi et al. “GlassGesture: Exploring head gesture interface of smart glasses”. In: *2016 IEEE Conference on Computer Communications Workshops (INFOCOM WKSHPs)* (2016). DOI: 10.1109/infcomw.2016.7562233.
- [224] Sang Ho Yoon, Ke Huo, and Karthik Ramani. “Plex: finger-worn textile sensor for mobile interaction during activities”. In: *Proceedings of the 2014 ACM International Joint Conference on Pervasive and Ubiquitous Computing: Adjunct Publication*. ACM. 2014, pp. 191–194.
- [225] Clint Zeagler. “Where to wear it: functional, technical, and social considerations in on-body location for wearable technology 20 years of designing for wearability”. In: *Proceedings of the 2017 ACM International Symposium on Wearable Computers*. 2017, pp. 150–157.

- [226] Yi Zhao, Joshua R. Smith, and Alanson Sample. “NFC-WISP: an open source software defined near field RFID sensing platform”. In: *Adjunct Proceedings of the 2015 ACM International Joint Conference on Pervasive and Ubiquitous Computing and Proceedings of the 2015 ACM International Symposium on Wearable Computers*. UbiComp/ISWC’15 Adjunct. Osaka, Japan: ACM, 2015, pp. 369–372. ISBN: 978-1-4503-3575-1. DOI: 10.1145/2800835.2800912. URL: <http://dl.acm.org/citation.cfm?id=2800912>.